

## 500mA Low Dropout Voltage Regulator

### ■ GENERAL DESCRIPTION

The NJU7223 series is a high precision output voltage, low drop output, low current consumption and high output current 3-terminal positive voltage regulator with a over current protection and a thermal shutdown.

Low dropout voltage is realized at high current output.

### ■ FEATURES

- High Precision Output       $\pm 2.0\%$
- Output Current               $I_o(\text{max.})=500\text{mA}$
- Low Current Consumption     $I_q=30\mu\text{A}$
- Low Dropout Voltage         $0.4\text{V typ. } (I_o=500\text{mA}, V_o=5.0\text{V})$
- Internal Over Current Protection
- Internal Thermal Shutdown Protection
- CMOS Technology
- Package Outline              TO-220F, TO-252

### ■ PACKAGE OUTLINE

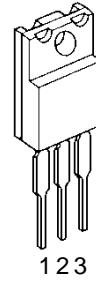

NJU7223F

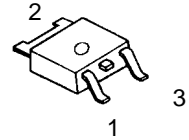

NJU7223DL1

### ■ PIN CONFIGURATION

1.  $V_{OUT}$
2.  $V_{IN}$
3. GND

### ■ EQUIVALENT CIRCUIT

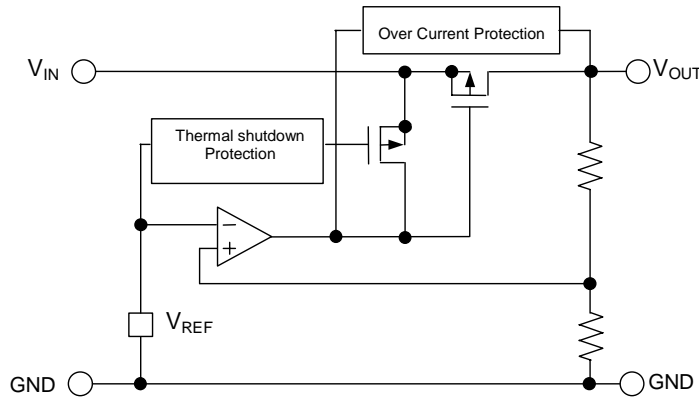

### ■ OUTPUT VOLTAGE RANK LIST

$V_{OUT}$	TO-220F	TO-252
+1.8V	NJU7223F18	NJU7223DL1-18
+2.5V	NJU7223F25	NJU7223DL1-25
+3.0V	NJU7223F30	NJU7223DL1-30
+3.3V	NJU7223F33	NJU7223DL1-33
+5.0V	NJU7223F50	NJU7223DL1-50

# NJU7223

## ■ ABSOLUTE MAXIMUM RATINGS (Ta=25°C)

PARAMETER	SYMBOL	RATINGS	UNIT
Input Voltage	$V_{IN}$	+18	V
Output Voltage	$V_{OUT}$	GND-0.3 ~ $V_{IN} + 0.3$	V
Output Current	$I_{OUT}$	700	mA
Power Dissipation	$P_D$	TO-220F 7.5(Tc≤85°C) TO-252 7.5(Tc≤56°C) 1.0(Ta=25°C)	W
Operating Temperature Range	Topr	-40 ~ 85	°C
Storage Temperature Range	Tstg	-55 ~ 150	°C

## ■ TEST CIRCUIT

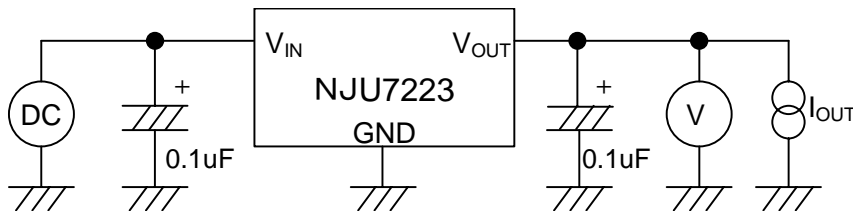

■ ELECTRICAL CHARACTERISTICS (C<sub>IN</sub>=C<sub>O</sub>=0.1μF, T<sub>j</sub>=25°C)

Measurement is to be conducted in pulse testing.

PARAMETER	SYMBOL	TEST CONDITION	MIN.	TYP.	MAX.	UNIT
<b>Vo=1.8V Version</b>						
Output Voltage	V <sub>O</sub>	V <sub>IN</sub> =3.8V, I <sub>o</sub> =300mA	1.764	1.80	1.836	V
Input Voltage	V <sub>IN</sub>		-	-	14	V
Dropout Voltage	ΔV <sub>IO</sub>	I <sub>o</sub> =150mA	-	0.4	0.6	V
Line Regulation	ΔV <sub>o</sub> /ΔV <sub>IN</sub> ·V <sub>o</sub>	V <sub>IN</sub> =2.8V ~ 12.0V	-	0.10	-	%/V
Load Regulation	ΔV <sub>o</sub> /ΔI <sub>o</sub>	V <sub>IN</sub> =3.8V, I <sub>o</sub> =1 ~ 500mA	-	120	160	mV
Quiescent Current	I <sub>DD</sub>	V <sub>IN</sub> =3.8V	-	30	60	μA
Ripple Rejection	RR	V <sub>IN</sub> =3.8V, e <sub>in</sub> =1V <sub>P-P</sub> f=120Hz, I <sub>o</sub> =300mA	-	57	-	dB
Output Noise Voltage	V <sub>NO</sub>	V <sub>IN</sub> =3.8V, I <sub>o</sub> =300mA BW=10Hz ~ 100kHz	-	65	-	μV
<b>Vo=2.5V Version</b>						
Output Voltage	V <sub>O</sub>	V <sub>IN</sub> =4.5V, I <sub>o</sub> =300mA	2.45	2.50	2.55	V
Input Voltage	V <sub>IN</sub>		-	-	14	V
Dropout Voltage	ΔV <sub>IO</sub>	I <sub>o</sub> =300mA	-	0.4	0.6	V
Line Regulation	ΔV <sub>o</sub> /ΔV <sub>IN</sub> ·V <sub>o</sub>	V <sub>IN</sub> =3.5V ~ 12.0V	-	0.10	-	%/V
Load Regulation	ΔV <sub>o</sub> /ΔI <sub>o</sub>	V <sub>IN</sub> =4.5V, I <sub>o</sub> =1 ~ 500mA	-	120	160	mV
Quiescent Current	I <sub>DD</sub>	V <sub>IN</sub> =4.5V	-	30	60	μA
Ripple Rejection	RR	V <sub>IN</sub> =4.5V, e <sub>in</sub> =1V <sub>P-P</sub> f=120Hz, I <sub>o</sub> =300mA	-	57	-	dB
Output Noise Voltage	V <sub>NO</sub>	V <sub>IN</sub> =4.5V, I <sub>o</sub> =300mA BW=10Hz ~ 100kHz	-	110	-	μV
<b>Vo=3.0V Version</b>						
Output Voltage	V <sub>O</sub>	V <sub>IN</sub> =5.0V, I <sub>o</sub> =300mA	2.94	3.00	3.06	V
Input Voltage	V <sub>IN</sub>		-	-	14	V
Dropout Voltage	ΔV <sub>IO</sub>	I <sub>o</sub> =300mA	-	0.4	0.6	V
Line Regulation	ΔV <sub>o</sub> /ΔV <sub>IN</sub> ·V <sub>o</sub>	V <sub>IN</sub> =4.0V ~ 12.0V	-	0.10	-	%/V
Load Regulation	ΔV <sub>o</sub> /ΔI <sub>o</sub>	V <sub>IN</sub> =5.0V, I <sub>o</sub> =1 ~ 500mA	-	120	160	mV
Quiescent Current	I <sub>DD</sub>	V <sub>IN</sub> =5.0V	-	30	60	μA
Ripple Rejection	RR	V <sub>IN</sub> =5.0V, e <sub>in</sub> =1V <sub>P-P</sub> f=120Hz, I <sub>o</sub> =300mA	-	57	-	dB
Output Noise Voltage	V <sub>NO</sub>	V <sub>IN</sub> =5.0V, I <sub>o</sub> =300mA BW=10Hz ~ 100kHz	-	115	-	μV

■ ELECTRICAL CHARACTERISTICS ( $C_{IN}=C_O=0.1\mu F$ ,  $T_j=25^\circ C$ )

Measurement is to be conducted in pulse testing.

PARAMETER	SYMBOL	TEST CONDITION	MIN.	TYP.	MAX.	UNIT
Vo=3.3V Version Output Voltage	$V_O$	$V_{IN}=5.3V$ , $I_o=300mA$	3.234	3.30	3.366	V
Input Voltage	$V_{IN}$		-	-	14	V
Dropout Voltage	$\Delta V_{IO}$	$I_o=300mA$	-	0.4	0.6	V
Line Regulation	$\Delta V_o/\Delta V_{IN}\cdot V_o$	$V_{IN}=4.3V \sim 12.0V$	-	0.10	-	%/V
Load Regulation	$\Delta V_o/\Delta I_o$	$V_{IN}=5.3V$ , $I_o=1 \sim 500mA$	-	120	160	mV
Quiescent Current	$I_{DD}$	$V_{IN}=5.3V$	-	30	60	$\mu A$
Ripple Rejection	RR	$V_{IN}=5.3V$ , $e_{in}=1V_{P-P}$ $f=120Hz$ , $I_o=300mA$	-	56	-	dB
Output Noise Voltage	$V_{NO}$	$V_{IN}=5.3V$ , $I_o=300mA$ $BW=10Hz \sim 100kHz$	-	117	-	$\mu V$
Vo=5.0V Version Output Voltage	$V_O$	$V_{IN}=7.0V$ , $I_o=500mA$	4.90	5.00	5.10	V
Input Voltage	$V_{IN}$		-	-	14	V
Dropout Voltage	$\Delta V_{IO}$	$I_o=500mA$	-	0.4	0.6	V
Line Regulation	$\Delta V_o/\Delta V_{IN}\cdot V_o$	$V_{IN}=6.0V \sim 12.0V$	-	0.10	-	%/V
Load Regulation	$\Delta V_o/\Delta I_o$	$V_{IN}=7.0V$ , $I_o=1 \sim 500mA$	-	120	160	mV
Quiescent Current	$I_{DD}$	$V_{IN}=7.0V$	-	30	60	$\mu A$
Ripple Rejection	RR	$V_{IN}=7.0V$ , $e_{in}=1V_{P-P}$ $f=120Hz$ , $I_o=300mA$	-	55	-	dB
Output Noise Voltage	$V_{NO}$	$V_{IN}=7.0V$ , $I_o=300mA$ $BW=10Hz \sim 100kHz$	-	122	-	$\mu V$

## TYPICAL CHARACTERISTICS

### Load Transient Response (Vo=3.3V version)

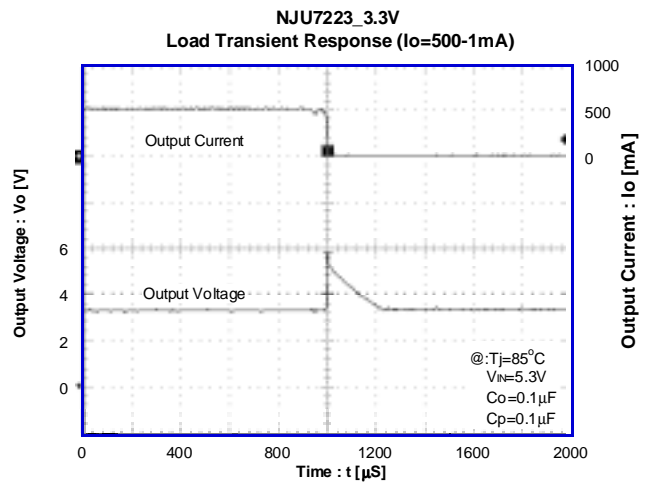
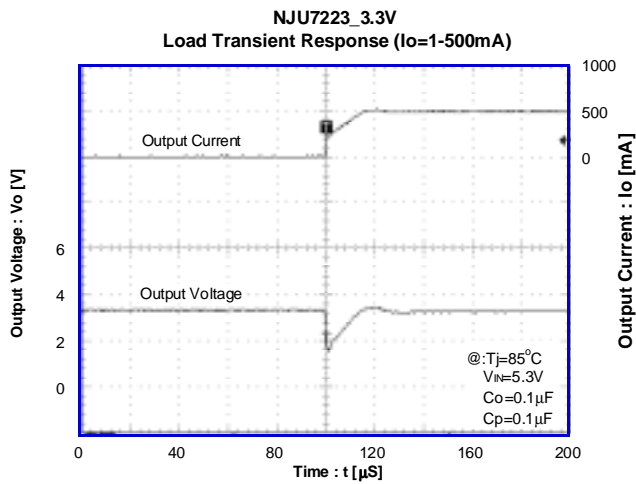
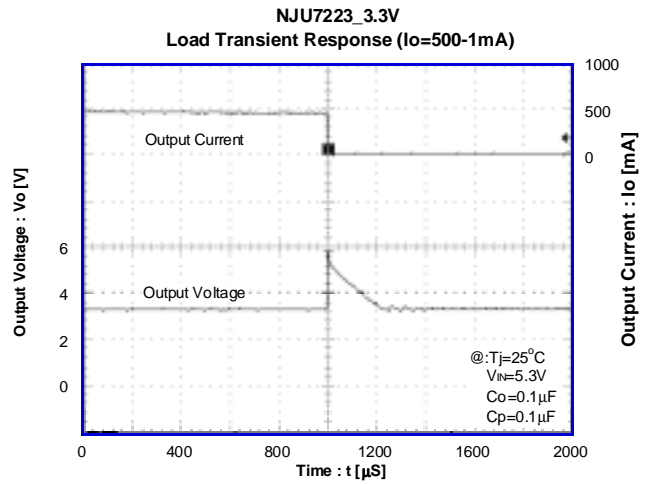
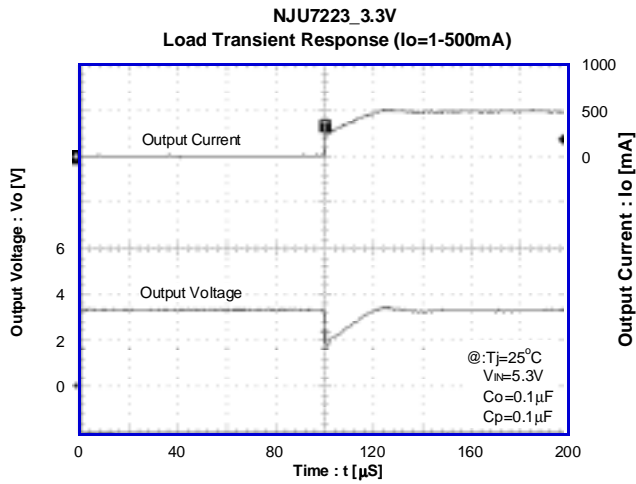
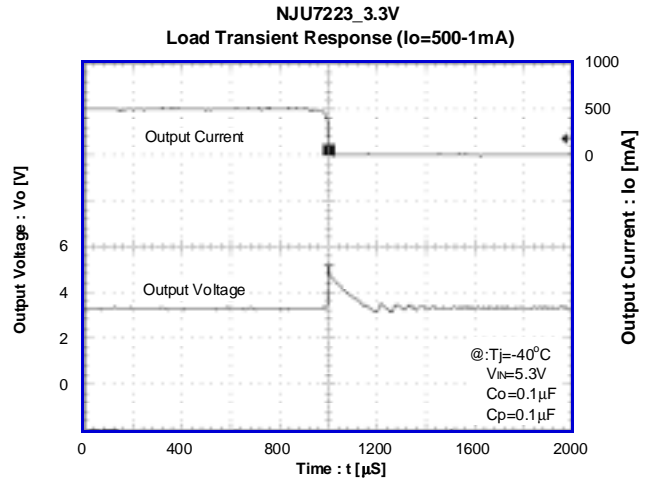
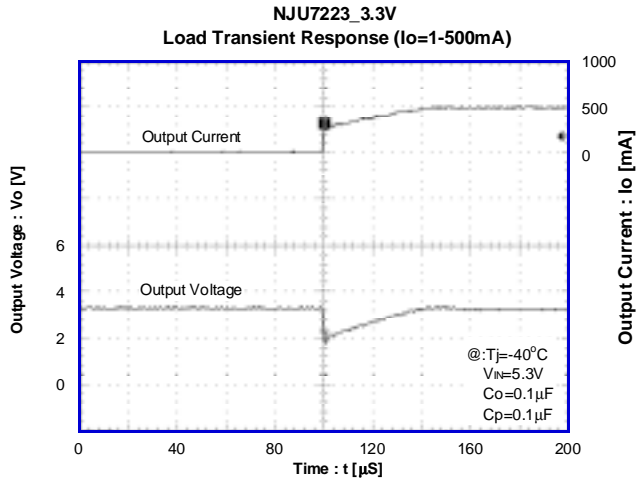

## ■ TYPICAL CHARACTERISTICS

### Load Transient Response (Vo=5.0V version)

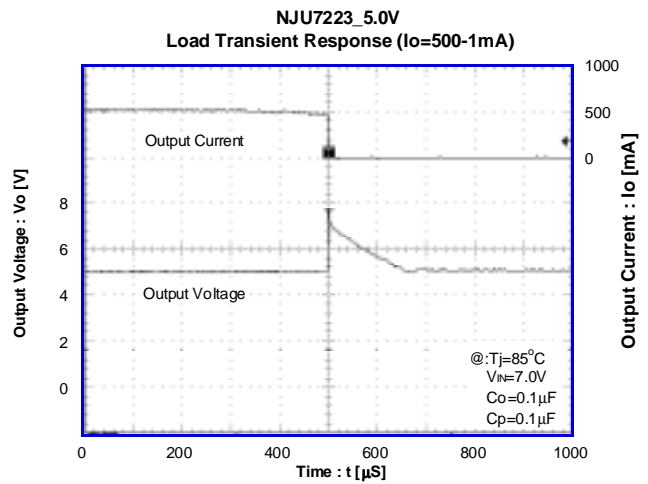
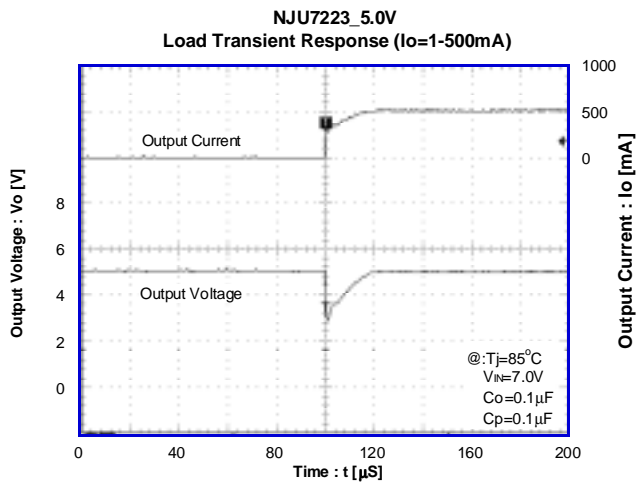
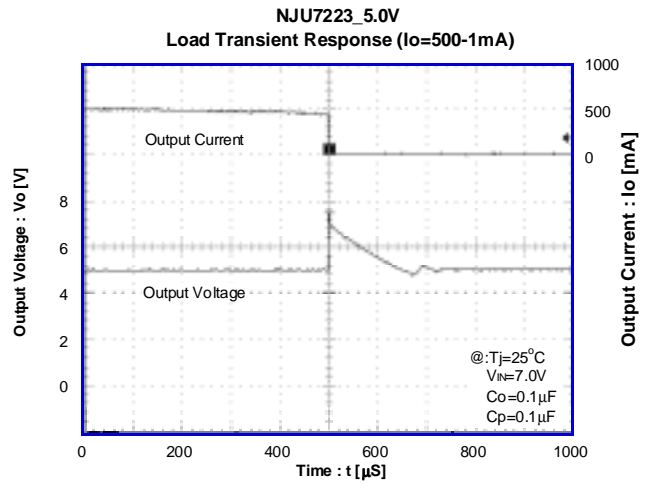
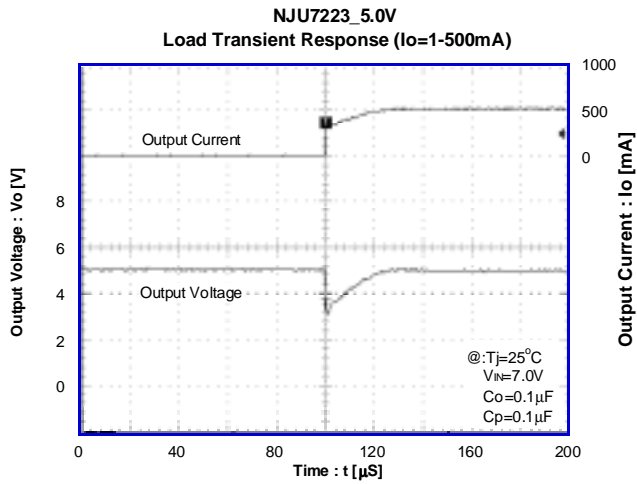
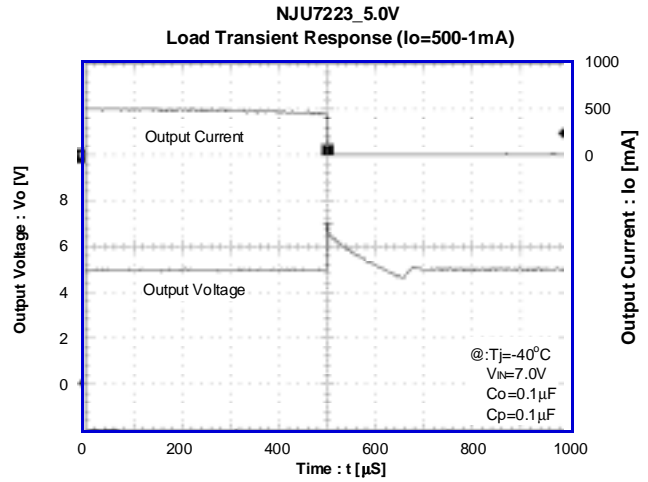
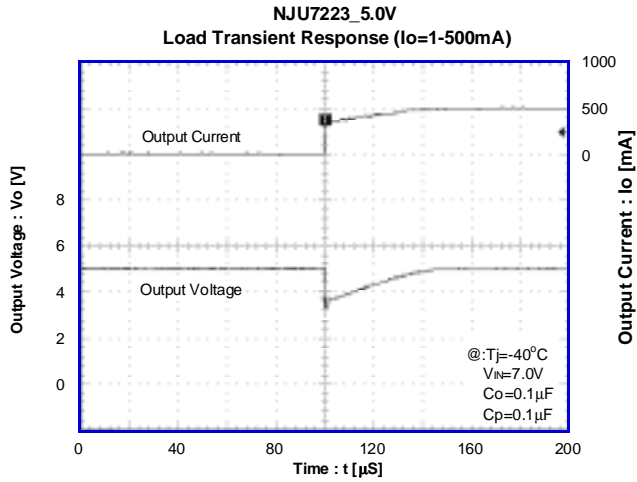

**[CAUTION]**

The specifications on this databook are only given for information, without any guarantee as regards either mistakes or omissions. The application circuits in this databook are described only to show representative usages of the product and not intended for the guarantee or permission of any right including the industrial rights.

# Mouser Electronics

Authorized Distributor

Click to View Pricing, Inventory, Delivery & Lifecycle Information:

[NJR:](#)

[NJU7223DL1-33-TE1](#) [NJU7223DL1-19-TE1](#) [NJU7223F25](#) [NJU7223F33](#) [NJU7223F30](#) [NJU7223F18](#) [NJU7223DL1-50-TE1](#) [NJU7223F50](#) [NJU7223DL1-30-TE1](#) [NJU7223DL1-18-TE1](#) [NJU7223DL1-25-TE1](#) [NJU7223DL1-25-TE2](#)