

---

## 800mA LDO REGULATOR

---

NO.EA-084-111027

### OUTLINE

The R1170x Series are positive voltage regulator ICs by CMOS process. The R1170x Series have features of high ripple rejection, low dropout voltage, high output voltage accuracy, low consumption current. Each of these ICs consists of a voltage reference unit, an error amplifier, resistor net for setting output voltage, a current limit circuit at short mode, a chip enable circuit, and thermal-shunt circuit. Output Voltage of R1170 is fixed in the IC.

Low consumption current by the merit of CMOS process and built-in transistors with low ON-resistance make low dropout voltage and chip enable function prolong the battery life. These regulators are remarkable improvement on the current regulators in terms of ripple rejection, input transient response, and load transient response.

Maximum Output Current is large for its compact size.

Thus, the R1170x Series are suitable for various power sources for portable appliances.

Since the packages for these ICs are the SOT-89-5 package, HSON-6, or HSOP-6J, high density mounting of the ICs on boards is possible.

### FEATURES

- Supply Current ..... Typ. 80 $\mu$ A
- Standby Current ..... Typ. 0.1 $\mu$ A
- Output Current ..... Min. 800mA ( $V_{IN}=V_{OUT}+1.0V$ )
- Dropout Voltage ..... Typ. 0.12V ( $V_{OUT}=3.0V, I_{OUT}=300mA$ )
- Output Voltage Accuracy .....  $\pm 2.0\%$
- Temperature-Drift Coefficient of Output Voltage ..... Typ.  $\pm 100ppm/^{\circ}C$
- Line Regulation ..... Typ. 0.05%/V
- Output Voltage ..... 1.5V to 5.0V (0.1V steps)  
(For other voltages, please refer to MARK INFORMATIONS.)
- Packages ..... HSON-6, SOT-89-5, HSOP-6J
- Built-in Current Limit Circuit
- Built-in Thermal Shutdown Circuit
- Ceramic capacitors are recommended to be used with this IC

### APPLICATIONS

- Local Power source for Notebook PC.
- Local Power source for portable appliances, cameras, and videos.
- Local Power source for equipment of battery-use.
- Local Power source for home appliances.

## BLOCK DIAGRAMS

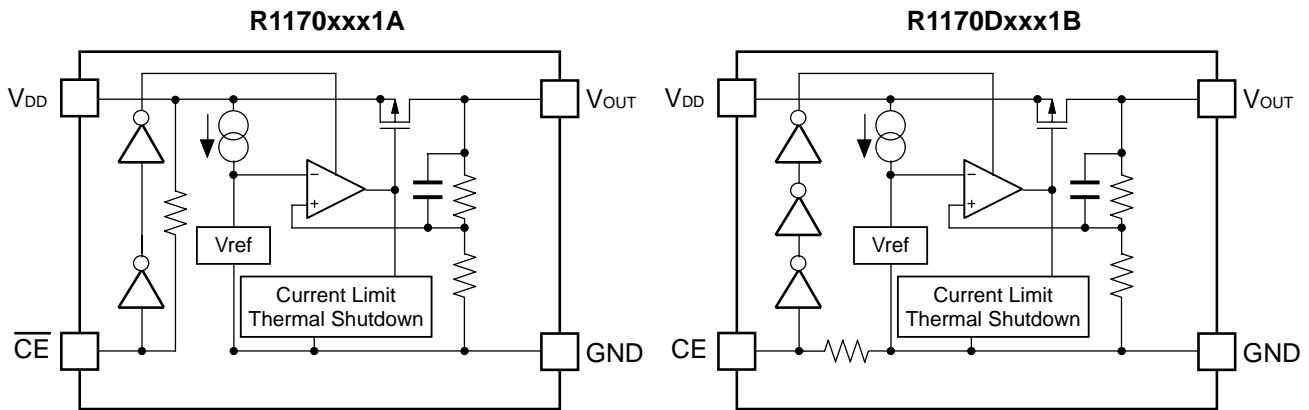

## SELECTION GUIDE

The output voltage, the chip-enable polarity, package for the ICs can be selected at the user's request.

Product Name	Package	Quantity per Reel	Pb Free	Halogen Free
R1170Dxx1*-TR-FE	HSOP-6	3,000 pcs	Yes	Yes
R1170Hxx1*-T1-FE	SOT-89-5	1,000 pcs	Yes	Yes
R1170Sxx1*-E2-FE	HSOP-6J	1,000 pcs	Yes	Yes

xx: The output voltage can be designated in the range from 1.5V(15) to 5.0V(50) in 0.1V steps.  
(For other voltages, please refer to MARK INFORMATIONS.)

\* : CE pin polarity are options as follows.

- (A) "L" active
- (B) "H" active

## PIN CONFIGURATION

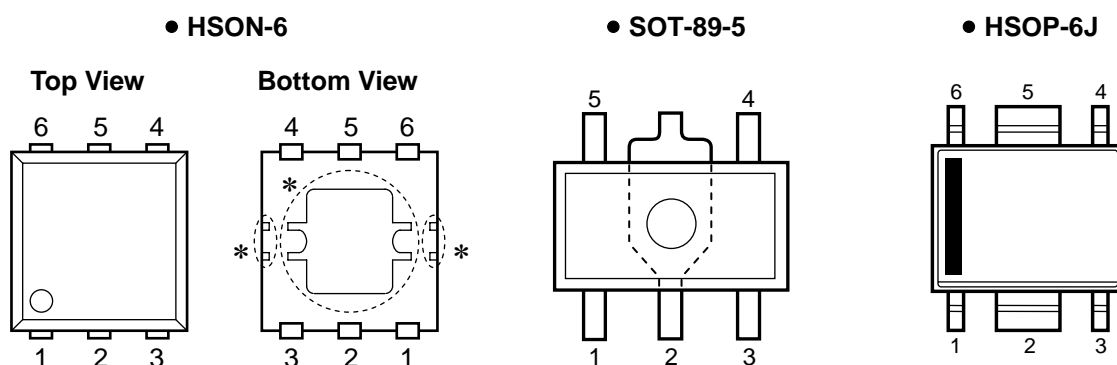

## PIN DESCRIPTION

### • HSON-6

Pin No	Symbol	Description
1	$V_{OUT}^{*1}$	Voltage Regulator Output Pin
2	$V_{OUT}^{*1}$	Voltage Regulator Output Pin
3	$\overline{CE}$ or CE	Chip Enable Pin
4	GND	Ground Pin
5	$V_{DD}^{*1}$	Input Pin
6	$V_{DD}^{*1}$	Input Pin

- \*) Tab and tab suspension leads in the  parts are GND level.  
 (They are connected to the reverse side of the IC.)  
 The tab is better to be connected to the GND, but leaving it open is also acceptable.  
 The tab suspension leads should be open and do not connect to other wires or land patterns.
- \*1) The  $V_{OUT}$  pin and  $V_{DD}$  pin must be wired each other when it is mounted on board.

### • SOT-89-5

Pin No	Symbol	Description
1	$\overline{CE}$ or CE	Chip Enable Pin
2	GND	Ground Pin
3	NC	No Connection
4	$V_{DD}$	Input Pin
5	$V_{OUT}$	Voltage Regulator Output Pin

• HSOP-6J

Pin No	Symbol	Description
1	V <sub>OUT</sub>	Voltage Regulator Output Pin
2	GND <sup>*1</sup>	Ground Pin
3	$\overline{\text{CE}}$ or CE	Chip Enable Pin
4	NC	No Connection
5	GND <sup>*1</sup>	Ground Pin
6	V <sub>DD</sub>	Input Pin

\*1) The GND pin must be wired together when it is mounted on board.

### ABSOLUTE MAXIMUM RATINGS

Symbol	Item	Rating	Unit
V <sub>IN</sub>	Input Voltage	7.0	V
V <sub>CE</sub>	Input Voltage ( $\overline{\text{CE}}$ or CE Input Pin)	-0.3 to V <sub>IN</sub> +0.3	V
V <sub>OUT</sub>	Output Voltage	-0.3 to V <sub>IN</sub> +0.3	V
P <sub>D</sub>	Power Dissipation (HSOP-6J)*	900	mW
	Power Dissipation (SOT-89-5)*	900	
	Power Dissipation (HSOP-6J)*	1700	
T <sub>opt</sub>	Operating Temperature	-40 to 85	°C
T <sub>stg</sub>	Storage Temperature	-55 to 125	°C

\*) For Power Dissipation, please refer to PACKAGE INFORMATION.

#### ABSOLUTE MAXIMUM RATINGS

Electronic and mechanical stress momentarily exceeded absolute maximum ratings may cause the permanent damages and may degrade the life time and safety for both device and system using the device in the field.

The functional operation at or over these absolute maximum ratings is not assured.

#### RECOMMENDED OPERATING CONDITIONS (ELECTRICAL CHARACTERISTICS)

All of electronic equipment should be designed that the mounted semiconductor devices operate within the recommended operating conditions. The semiconductor devices cannot operate normally over the recommended operating conditions, even if when they are used over such conditions by momentary electronic noise or surge. And the semiconductor devices may receive serious damage when they continue to operate over the recommended operating conditions.

## ELECTRICAL CHARACTERISTICS

### • R1170xxxxA

T<sub>opt</sub>=25°C

Symbol	Item	Conditions	Min.	Typ.	Max.	Unit	
V <sub>IN</sub>	Input Voltage				6.0	V	
I <sub>SS</sub>	Supply Current	V <sub>IN</sub> -V <sub>OUT</sub> =1.0V, V <sub>CE</sub> =GND		80	160	μA	
I <sub>standby</sub>	Standby Current	V <sub>IN</sub> =V <sub>CE</sub> =6.0V		0.1	1.0	μA	
V <sub>OUT</sub>	Output voltage	V <sub>IN</sub> -V <sub>OUT</sub> =1.0V I <sub>OUT</sub> =100mA	×0.98		×1.02	V	
ΔV <sub>OUT</sub> / ΔI <sub>OUT</sub>	Load regulation	V <sub>IN</sub> -V <sub>OUT</sub> =1.0V 1mA ≤ I <sub>OUT</sub> ≤ 300mA		30	100	mV	
V <sub>DIF</sub>	Dropout Voltage	I <sub>OUT</sub> =300mA	V <sub>OUT</sub> =1.5V		0.35	0.45	V
			V <sub>OUT</sub> =1.6V		0.30	0.35	
			V <sub>OUT</sub> =1.7V		0.25	0.30	
			1.8V ≤ V <sub>OUT</sub> ≤ 2.0V		0.20	0.25	
			2.1V ≤ V <sub>OUT</sub> ≤ 2.4V		0.15	0.20	
			2.5V ≤ V <sub>OUT</sub> ≤ 5.0V		0.12	0.18	
ΔV <sub>OUT</sub> / ΔV <sub>IN</sub>	Line regulation	I <sub>OUT</sub> =100mA V <sub>OUT</sub> +0.5V ≤ V <sub>IN</sub> ≤ 6.0V		0.05	0.30	%/V	
RR	Ripple Rejection	1.5V ≤ V <sub>OUT</sub> ≤ 4.7V: f=1kHz, V <sub>IN</sub> -V <sub>OUT</sub> =1.0V Ripple 0.5Vp-p		50		dB	
		4.8V ≤ V <sub>OUT</sub> ≤ 5.0V: f=1kHz, V <sub>IN</sub> =5.7V Ripple 0.5Vp-p		50			
ΔV <sub>OUT</sub> / ΔT <sub>opt</sub>	Output Voltage Temperature Coefficient	I <sub>OUT</sub> =10mA, V <sub>IN</sub> -V <sub>OUT</sub> =1.0V -40°C ≤ T <sub>opt</sub> ≤ 85°C		±100		ppm/ °C	
I <sub>LIM</sub>	Output Current	V <sub>IN</sub> -V <sub>OUT</sub> =1.0V	800			mA	
I <sub>SC</sub>	Short Current Limit	V <sub>OUT</sub> =0V		40		mA	
R <sub>PU</sub>	Pull-up resistance for $\overline{CE}$ pin		1.25	2.50	5.00	MΩ	
V <sub>CEH</sub>	$\overline{CE}$ Input Voltage "H"		1.50		V <sub>IN</sub>	V	
V <sub>CEL</sub>	$\overline{CE}$ Input Voltage "L"		0		0.25	V	
T <sub>TSD</sub>	Thermal Shutdown Detector Threshold Temperature	Junction Temperature		150		°C	
T <sub>TSR</sub>	Thermal Shutdown Released Temperature	Junction Temperature		120		°C	

## R1170x

### • R1170xxxxB

T<sub>opt</sub>=25°C

Symbol	Item	Conditions	Min.	Typ.	Max.	Unit	
V <sub>IN</sub>	Input voltage				6.0	V	
I <sub>SS</sub>	Supply Current	V <sub>IN</sub> -V <sub>OUT</sub> =1.0V, V <sub>CE</sub> =V <sub>IN</sub>		80	160	μA	
I <sub>standby</sub>	Standby Current	V <sub>IN</sub> =6.0V, V <sub>CE</sub> =GND		0.1	1.0	μA	
V <sub>OUT</sub>	Reference Voltage for Adjustable Voltage Regulator	V <sub>IN</sub> -V <sub>OUT</sub> =1.0V I <sub>OUT</sub> =100mA	×0.98		×1.02	V	
ΔV <sub>OUT</sub> / ΔI <sub>OUT</sub>	Load regulation	V <sub>IN</sub> -V <sub>OUT</sub> =1.0V 1mA ≤ I <sub>OUT</sub> ≤ 300mA		30	100	mV	
V <sub>DIF</sub>	Dropout Voltage	I <sub>OUT</sub> =300mA	V <sub>OUT</sub> =1.5V		0.35	0.45	
			V <sub>OUT</sub> =1.6V		0.30	0.35	
			V <sub>OUT</sub> =1.7V		0.25	0.30	
			1.8V ≤ V <sub>OUT</sub> ≤ 2.0V		0.20	0.25	
			2.1V ≤ V <sub>OUT</sub> ≤ 2.4V		0.15	0.20	
			2.5V ≤ V <sub>OUT</sub> ≤ 5.0V		0.12	0.18	
ΔV <sub>OUT</sub> / ΔV <sub>IN</sub>	Line regulation	I <sub>OUT</sub> =100mA V <sub>OUT</sub> +0.5V ≤ V <sub>IN</sub> ≤ 6.0V		0.05	0.30	%/V	
RR	Ripple Rejection	1.5V ≤ V <sub>OUT</sub> ≤ 4.7V: f=1kHz, V <sub>IN</sub> -V <sub>OUT</sub> =1.0V Ripple 0.5Vp-p		50		dB	
		4.8V ≤ V <sub>OUT</sub> ≤ 5.0V: f=1kHz, V <sub>IN</sub> =5.7V Ripple 0.5Vp-p		50			
ΔV <sub>OUT</sub> / ΔT <sub>opt</sub>	Output Voltage Temperature Coefficient	I <sub>OUT</sub> =10mA, V <sub>IN</sub> -V <sub>OUT</sub> =1.0V -40°C ≤ T <sub>opt</sub> ≤ 85°C		±100		ppm/ °C	
I <sub>LIM</sub>	Output Current	V <sub>IN</sub> -V <sub>OUT</sub> =1.0V	800			mA	
I <sub>SC</sub>	Short Current Limit	V <sub>OUT</sub> =0V		40		mA	
R <sub>PD</sub>	Pull-down resistance for CE pin		1.25	2.50	5.00	MΩ	
V <sub>CEH</sub>	CE Input Voltage "H"		1.5		V <sub>IN</sub>	V	
V <sub>CEL</sub>	CE Input Voltage "L"		0		0.25	V	
T <sub>TSD</sub>	Thermal Shutdown Detector Threshold Temperature	Junction Temperature		150		°C	
T <sub>TSR</sub>	Thermal Shutdown Released Temperature	Junction Temperature		120		°C	

## TEST CIRCUITS

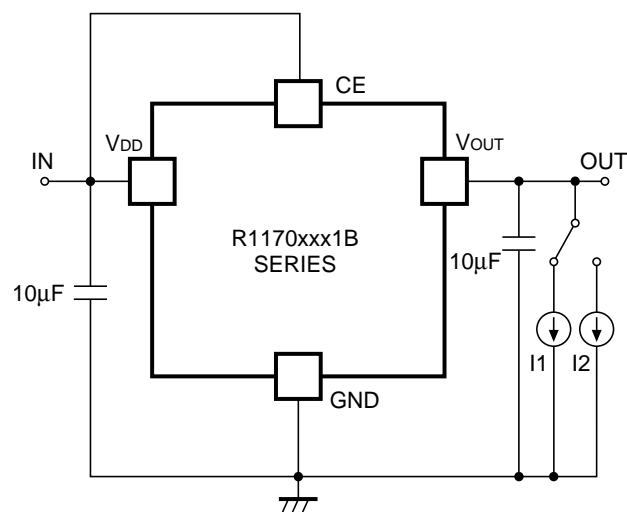
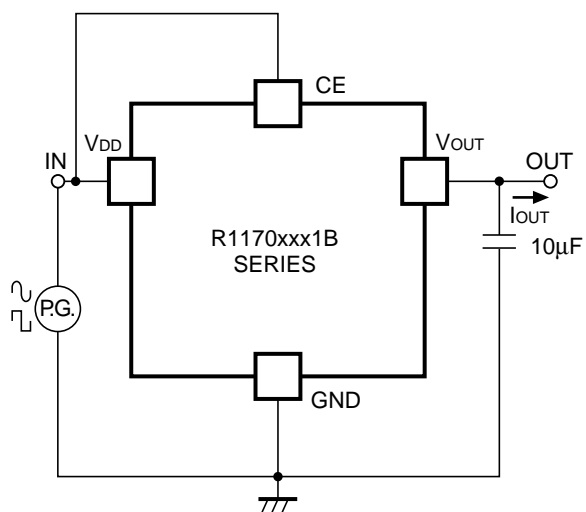
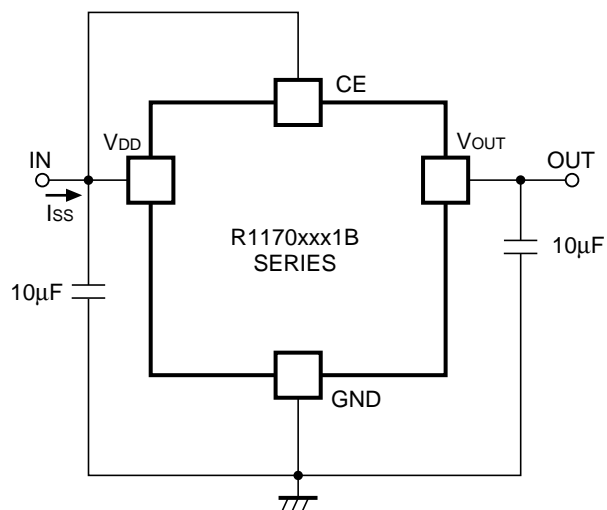
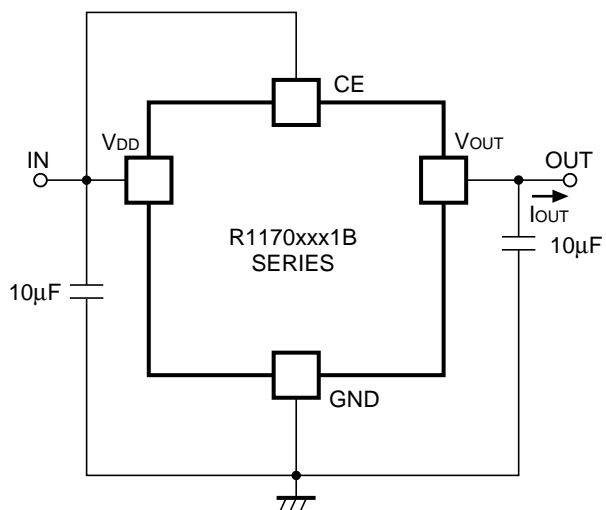

## Technical Notes on External Components and Typical Application

### Phase Compensation

In these ICs, phase compensation is made with the output capacitor for securing stable operation even if the load current is varied. For this purpose, use as much as 10 $\mu$ F Capacitor as  $C_L$ .

If you use a tantalum type capacitor and ESR value of the capacitor is large, output might be unstable. Evaluate your circuit with considering frequency characteristics. Further, refer to the Typical Characteristics No. 12.

### Mounting on PCB

Make  $V_{DD}$  and GND lines sufficient. If their impedance is high, a current flows, the noise picked up or unstable operation may result. Further use as much as 10 $\mu$ F capacitor between  $V_{DD}$  pin and GND pin as close as possible.

Set an Output capacitor between  $V_{OUT}$  pin and GND pin for phase compensation as close as possible.  
(Refer to the example of typical application)

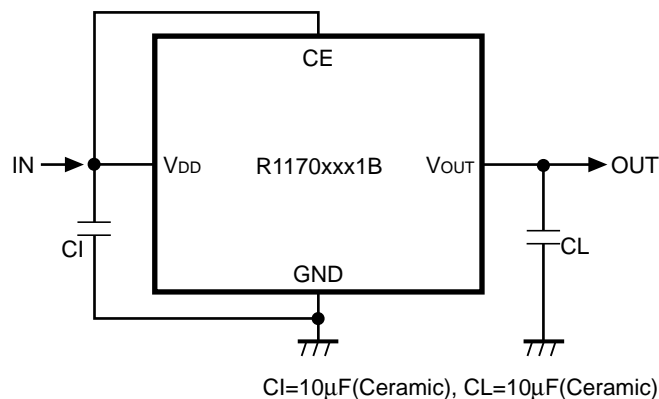

**Example of the typical application of R1170xxxxB**



## TYPICAL CHARACTERISTICS

### 1) Output Voltage vs. Output Current ( $T_{opt}=25^{\circ}\text{C}$ )

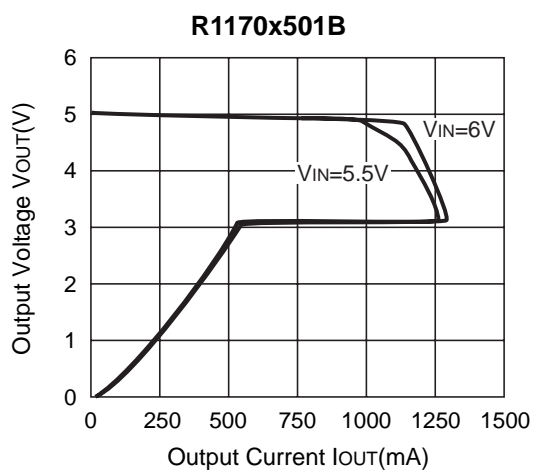
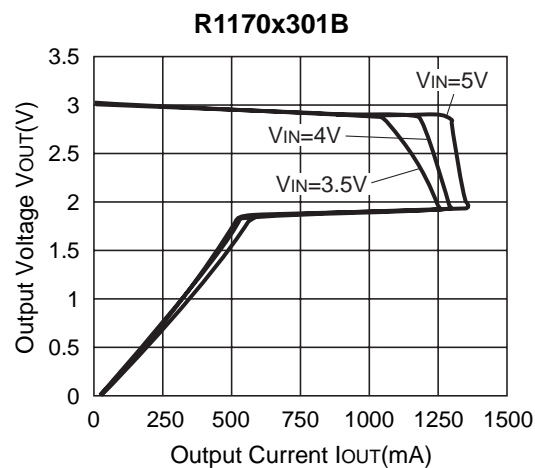
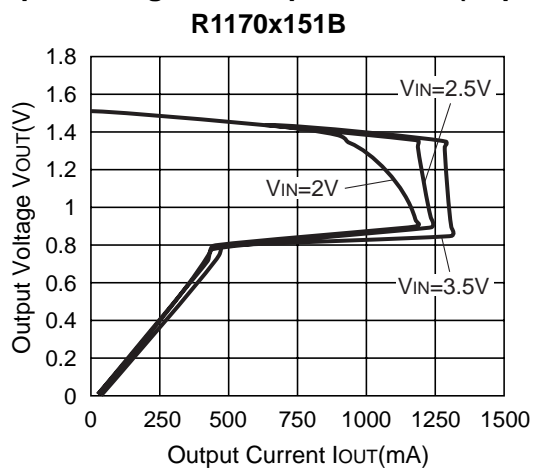

### 2) Output Voltage vs. Input Voltage ( $T_{opt}=25^{\circ}\text{C}$ )

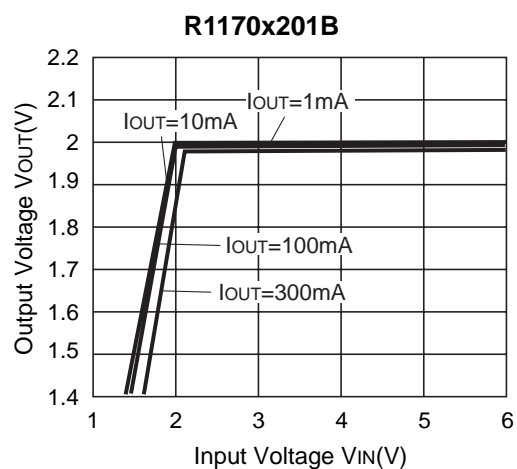
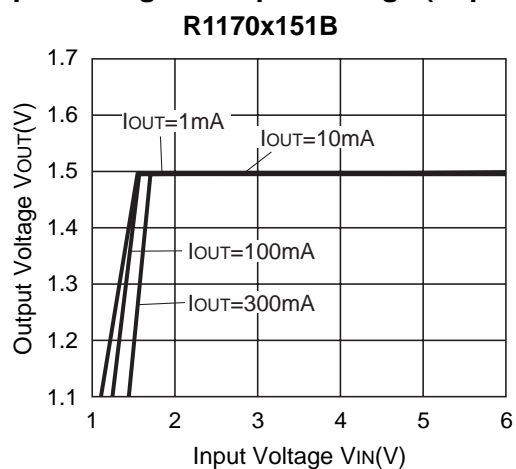

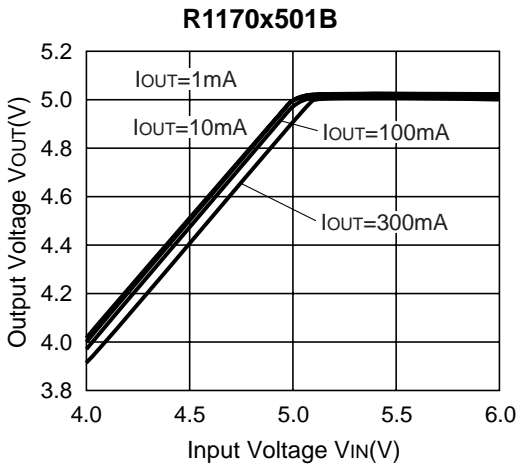
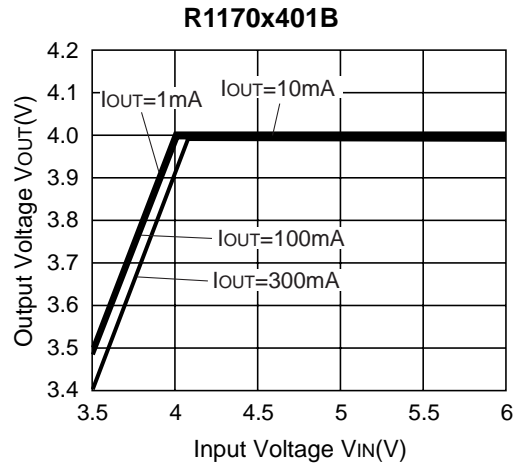
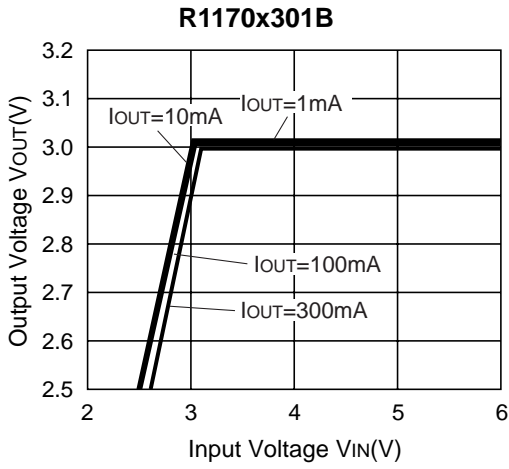

**3) Dropout Voltage vs. Output Current**

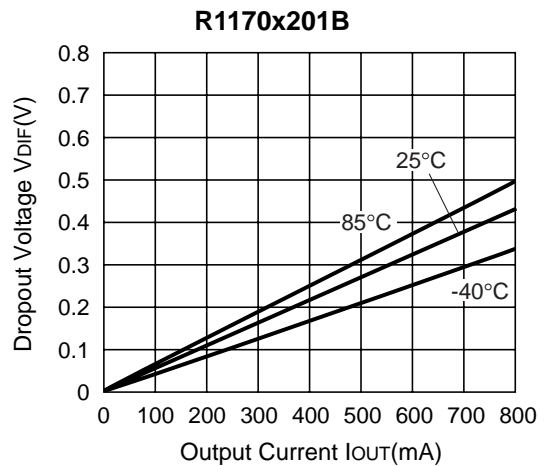
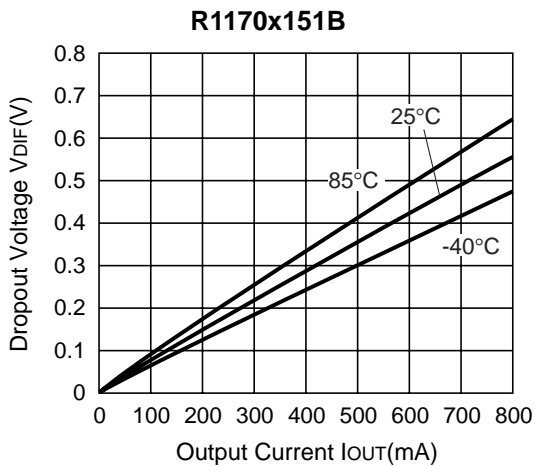

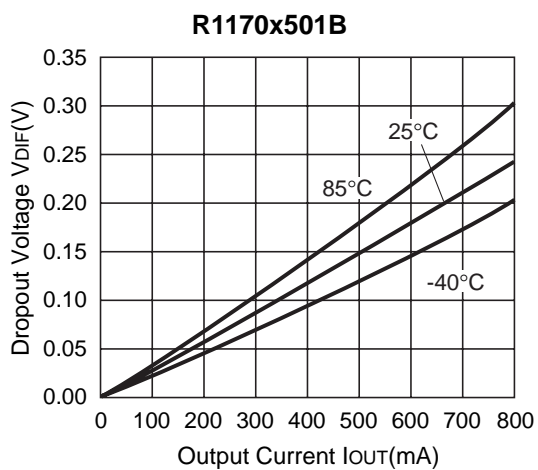
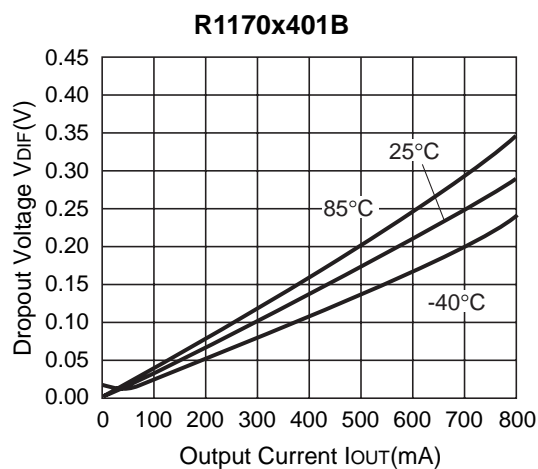
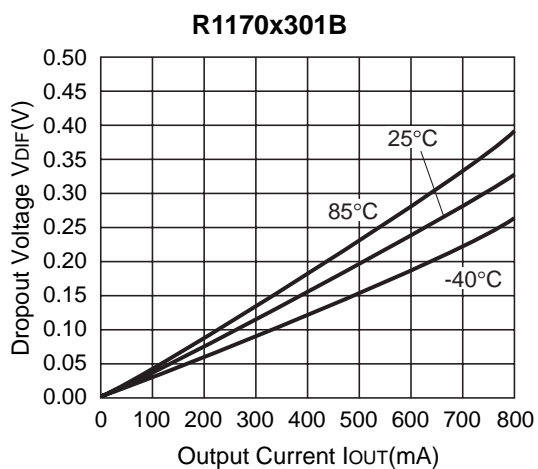

**4) Output Voltage vs. Temperature**

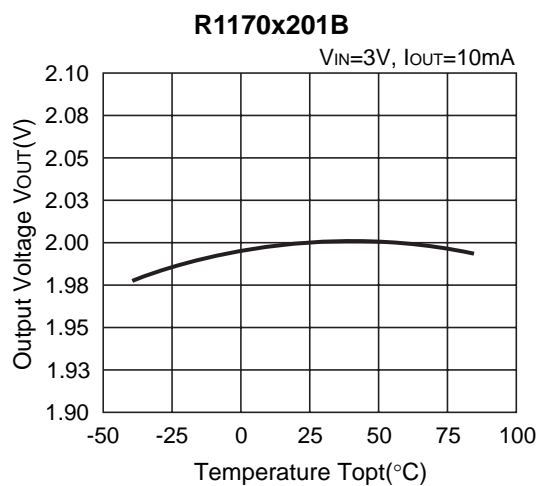
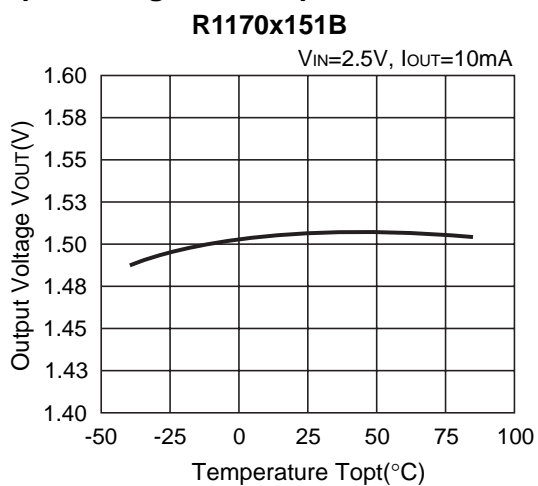

**R1170x301B**

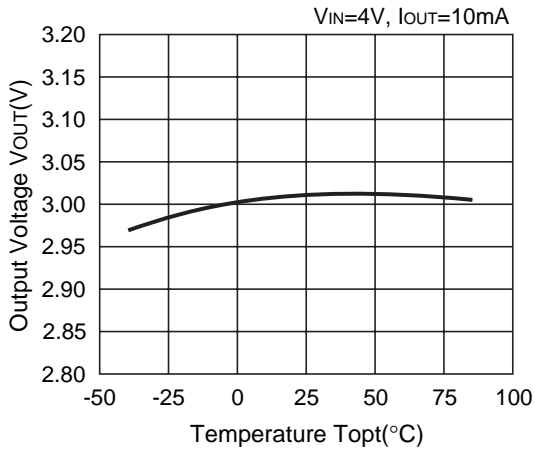

**R1170x401B**

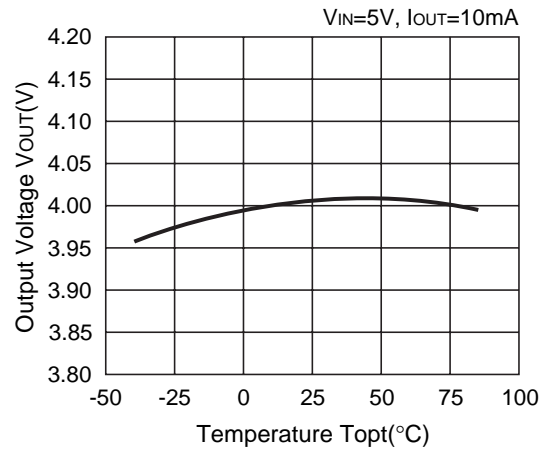

**R1170x501B**

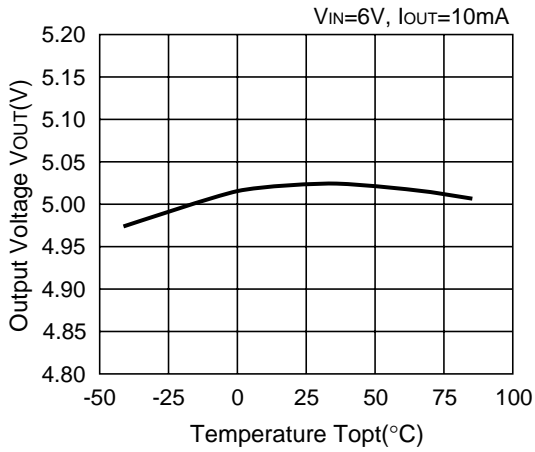

**5) Supply Current vs. Input Voltage (Topt=25°C)**

**R1170x151B**

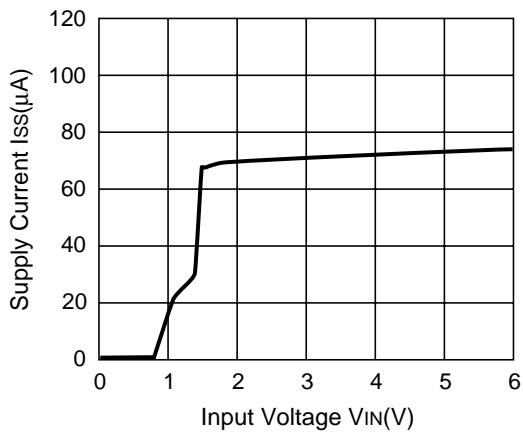

**R1170x201B**

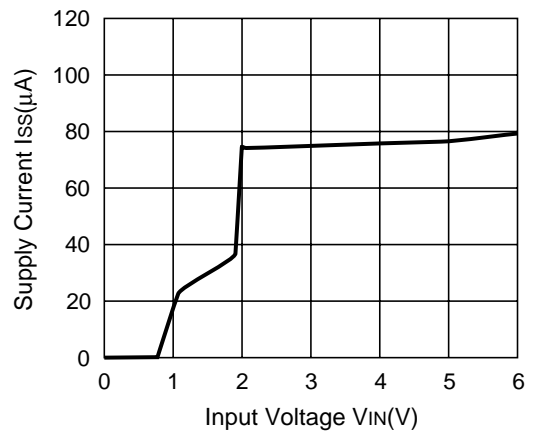

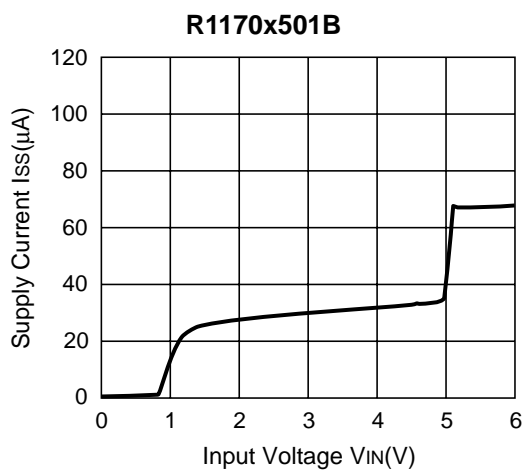
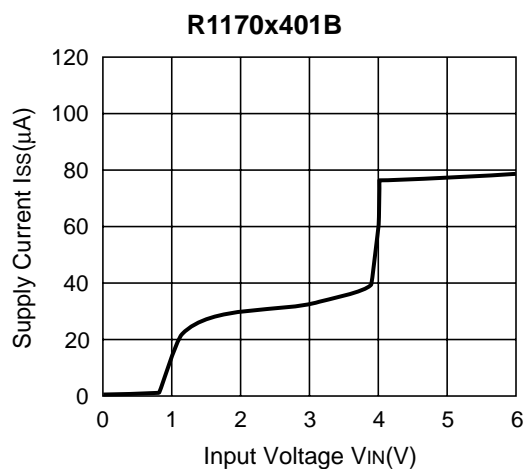
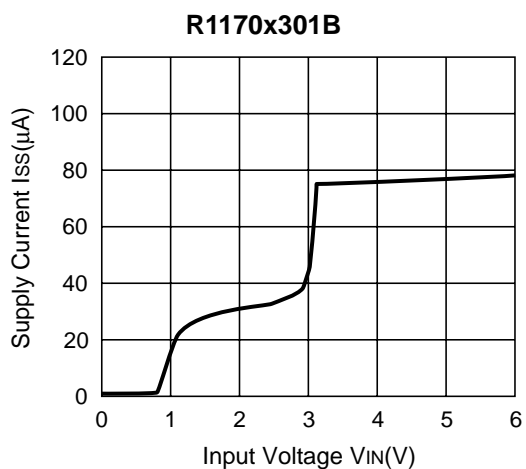

**6) Supply Current vs. Temperature**

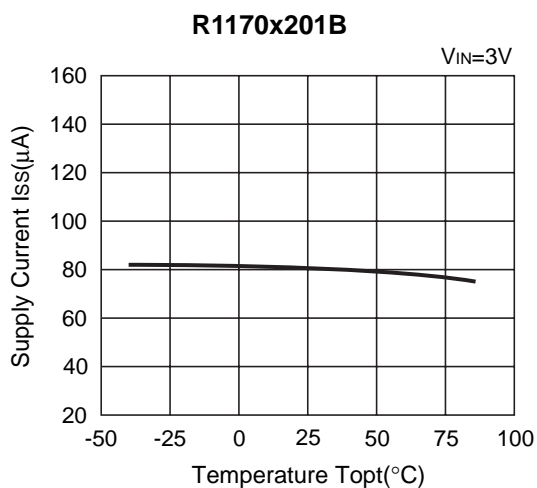
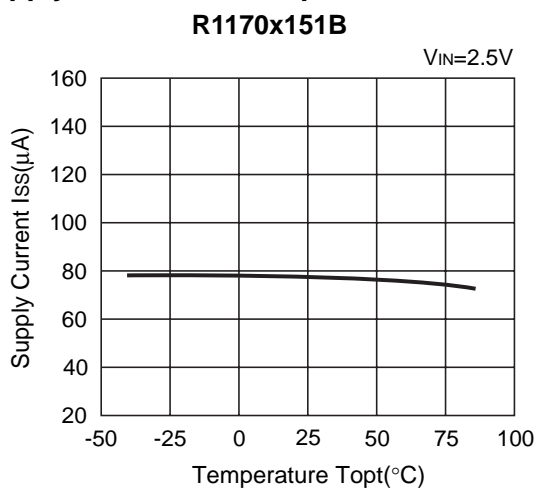

# R1170x

**R1170x301B**

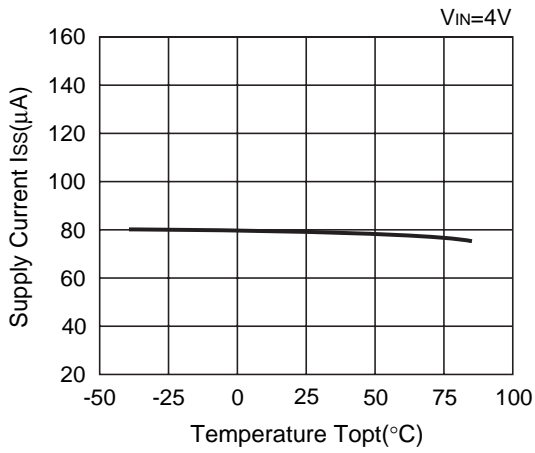

**R1170x401B**

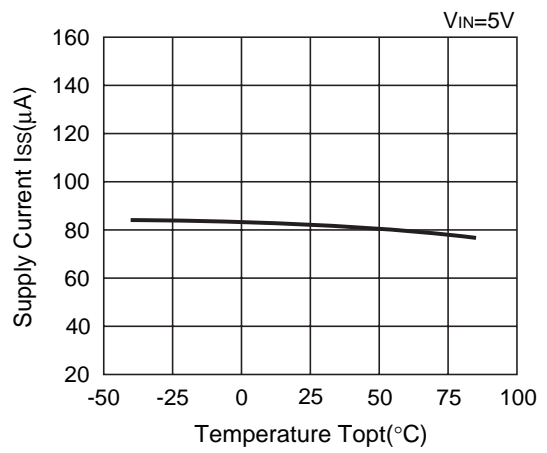

**R1170x501B**

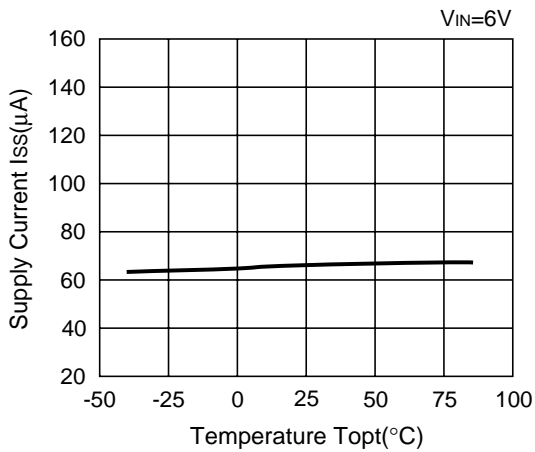

## 7) Dropout Voltage vs. Set Output Voltage (T<sub>opt</sub>=25°C)

**R1170x**

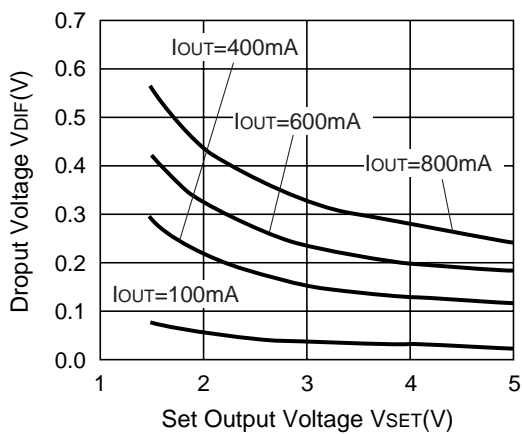

## 8) Ripple Rejection vs. Frequency

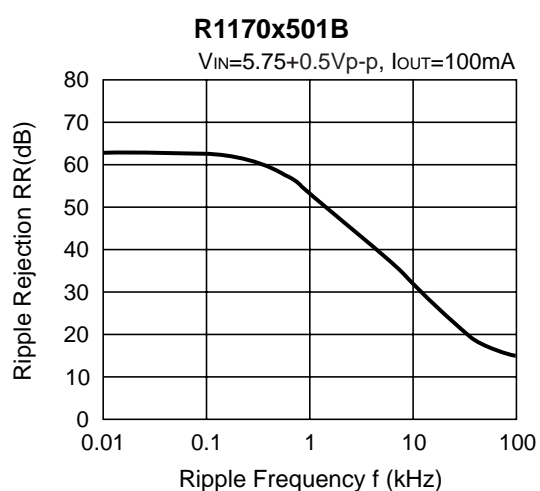
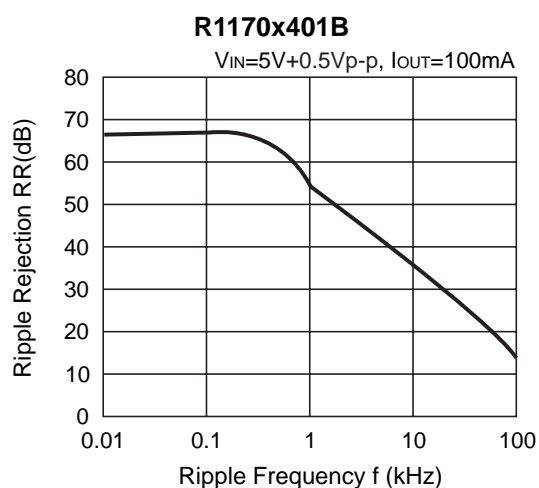
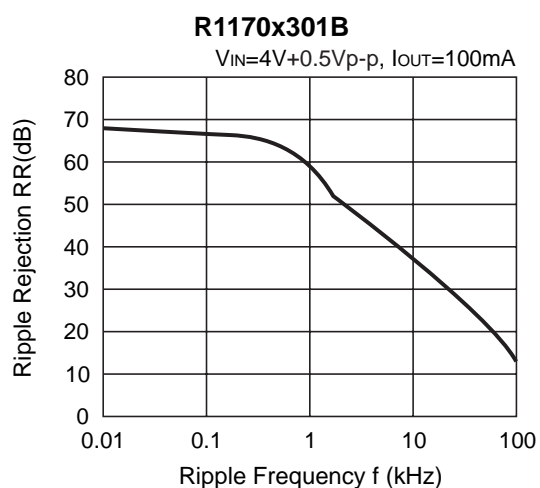
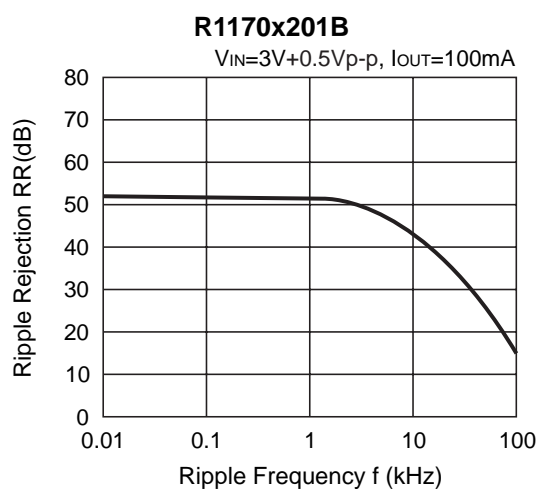
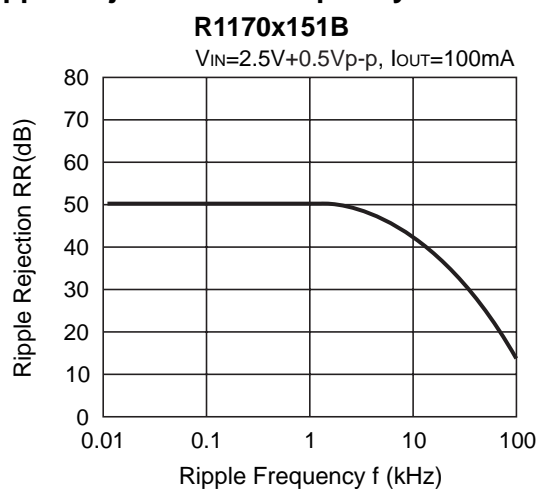

9) Ripple Rejection vs. Input Voltage

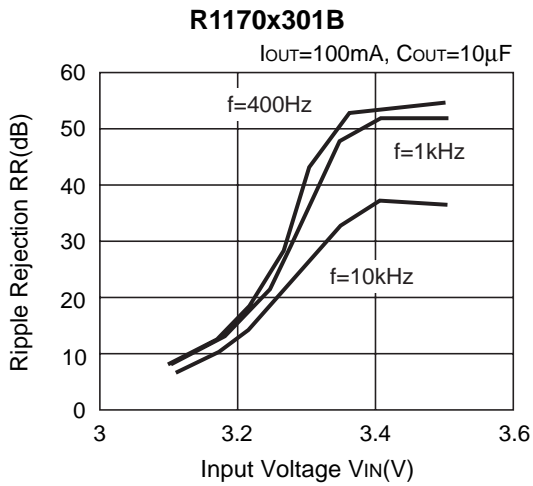
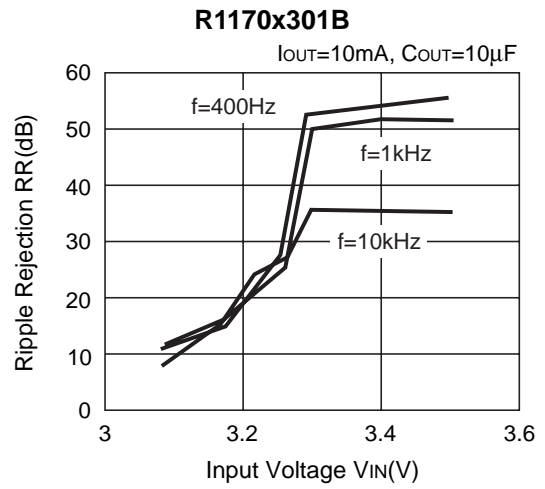
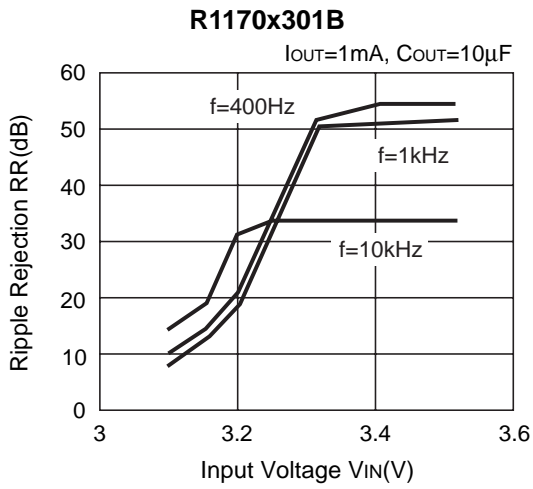

10) Input Transient Response (T<sub>opt</sub>=25°C)

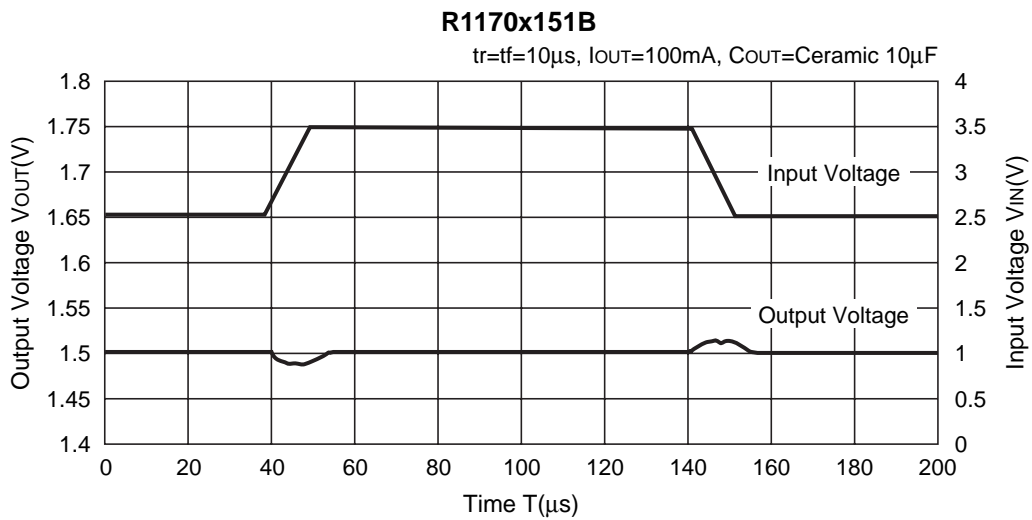



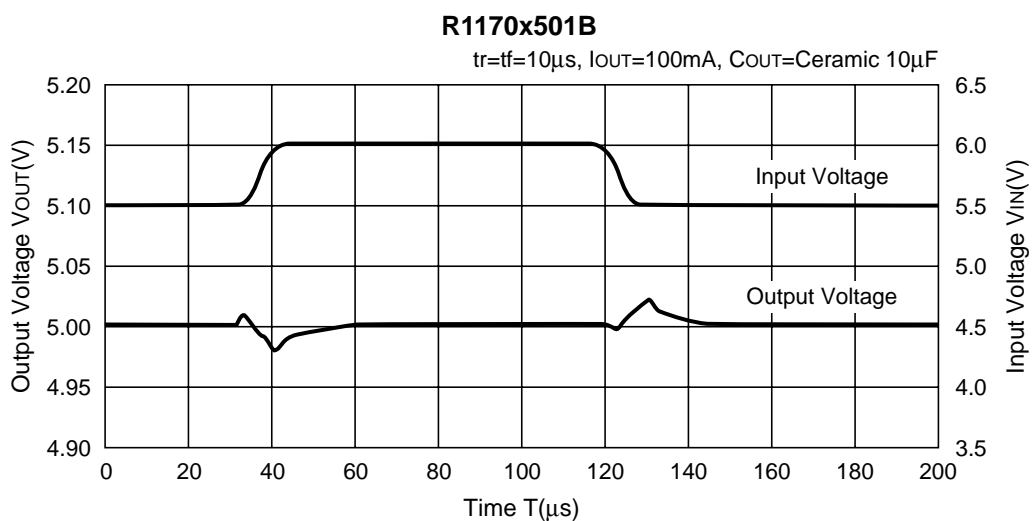
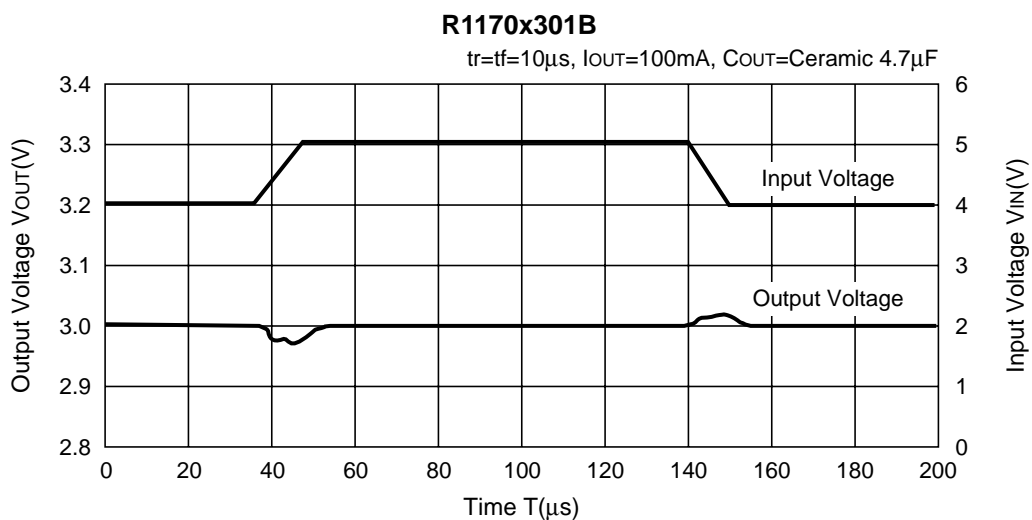
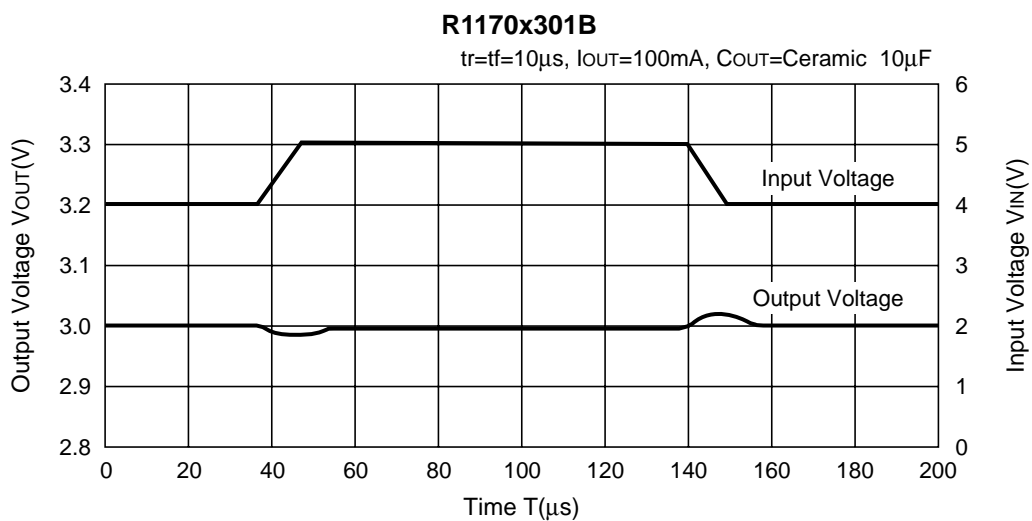

**R1170x501B**

$t_r=t_f=10\mu s$ ,  $I_{OUT}=100mA$ ,  $C_{OUT}=\text{Ceramic } 4.7\mu F$

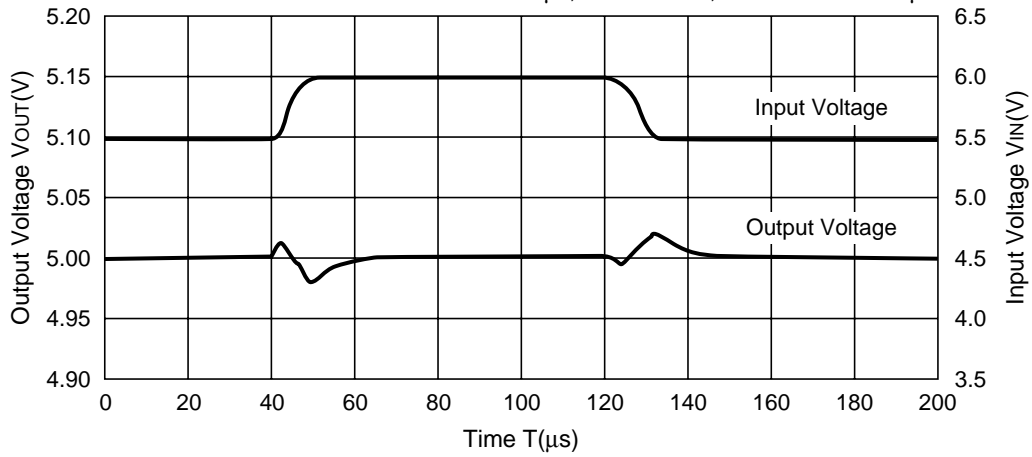

**11) Load Transient Response (T<sub>opt</sub>=25°C)**

**R1170x151B**

$t_r=t_f=3\mu s$ ,  $C_{IN}=\text{Ceramic } 10\mu F$ ,  $V_{IN}=2.5V$ ,  $C_{OUT}=\text{Ceramic } 10\mu F$

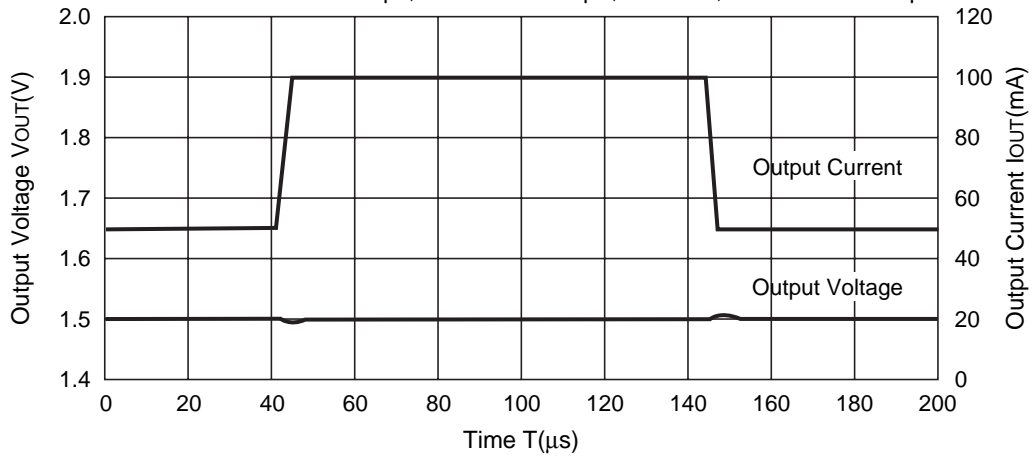

**R1170x301B**

$t_r=t_f=3\mu s$ ,  $C_{IN}=\text{Ceramic } 10\mu F$ ,  $V_{IN}=4V$ ,  $C_{OUT}=\text{Ceramic } 10\mu F$

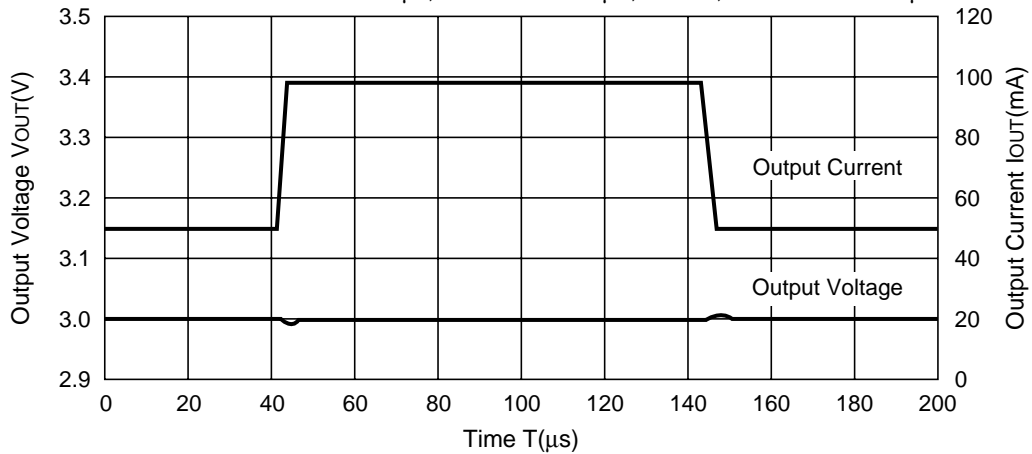

**R1170x301B**

$t_r=t_f=3\mu s$ ,  $C_{IN}=\text{Ceramic } 10\mu F$ ,  $V_{IN}=4V$ ,  $C_{OUT}=\text{Ceramic } 4.7\mu F$

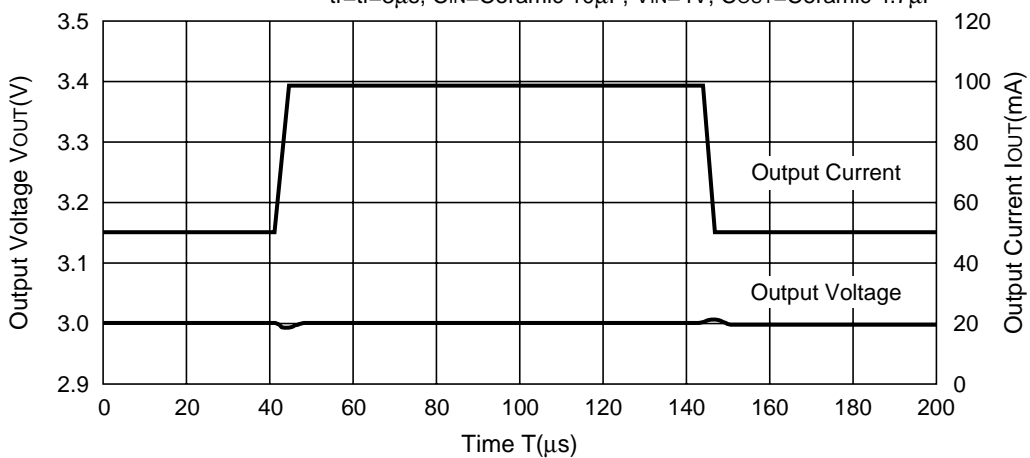

**R1170x501B**

$t_r=t_f=3\mu s$ ,  $C_{IN}=\text{Ceramic } 10\mu F$ ,  $C_{OUT}=\text{Ceramic } 10\mu F$

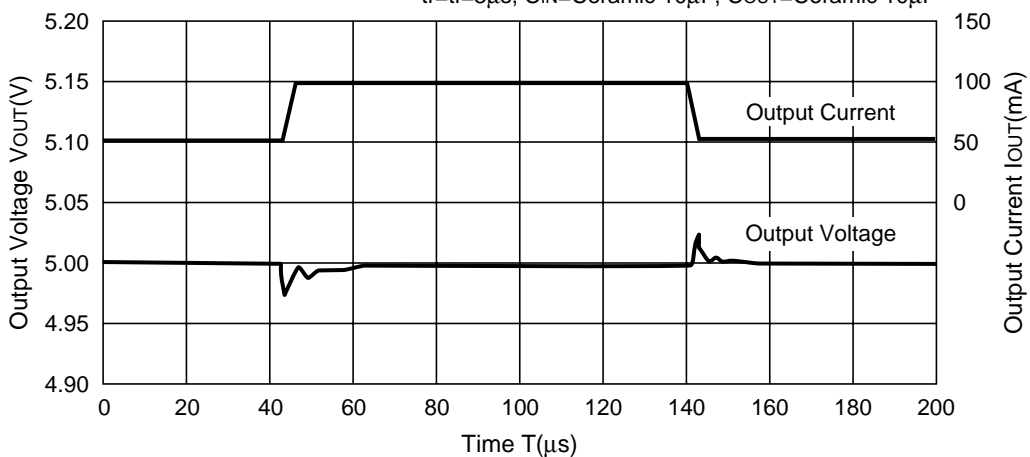

**R1170x501B**

$t_r=t_f=3\mu s$ ,  $C_{IN}=\text{Ceramic } 10\mu F$ ,  $C_{OUT}=\text{Ceramic } 4.7\mu F$

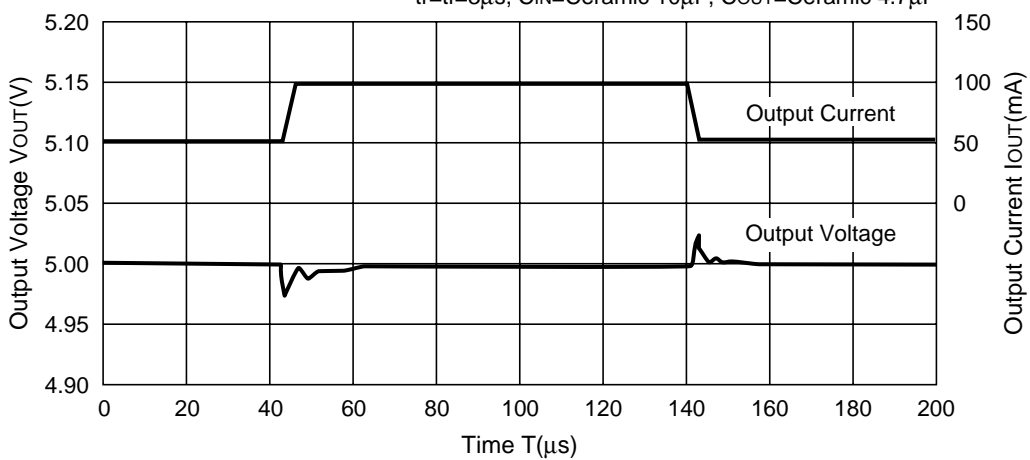

12) Stable Area (Topt=25°C, VIN = Set Output Voltage+1V, CIN = Ceramic 10µF)

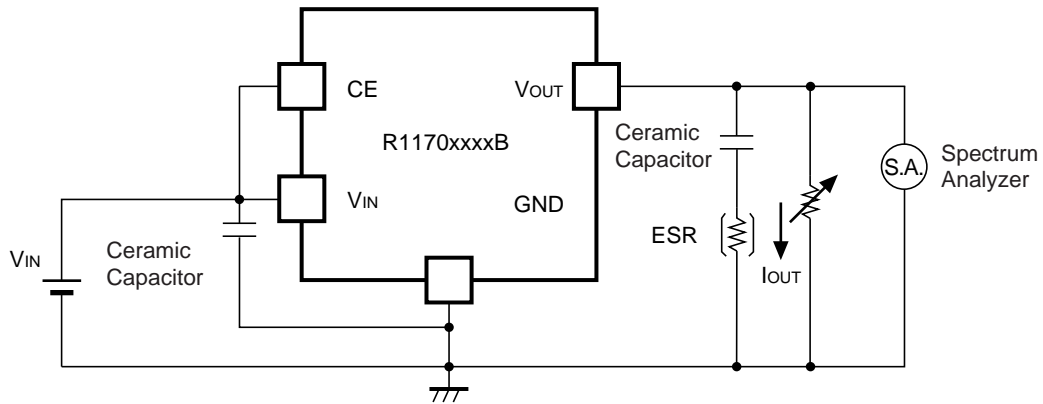

As an output capacitor for this IC, Ceramic capacitor is recommendable. However, other low ESR type capacitor can be used with this IC.

For your reference, noise level is tested with the circuit as shown above, and if the noise level is 40µV or less than 40µV, the ESR values are plotted as stable area. Upper limit is described in the next four graphs, or ESR vs. Output Current. (Hatched area is the stable area.)

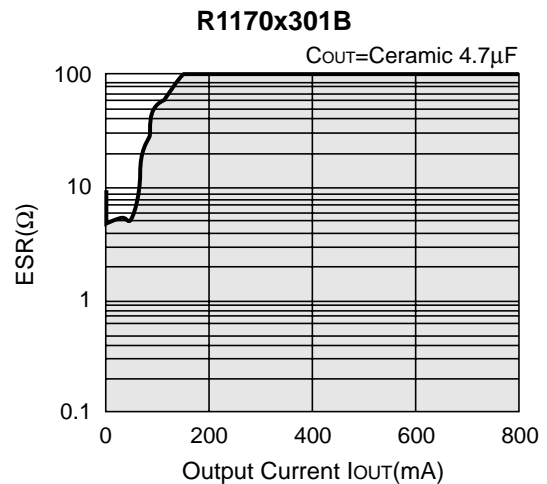
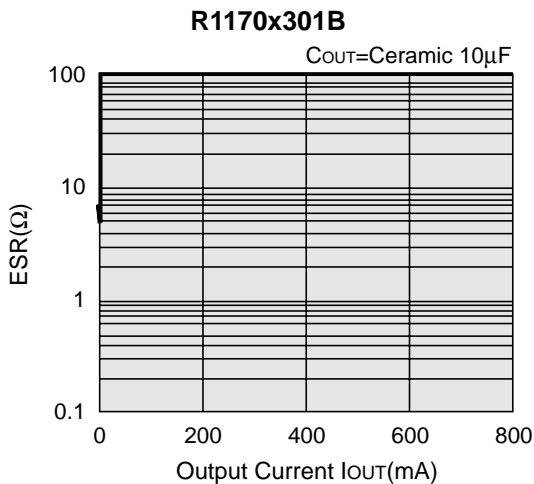
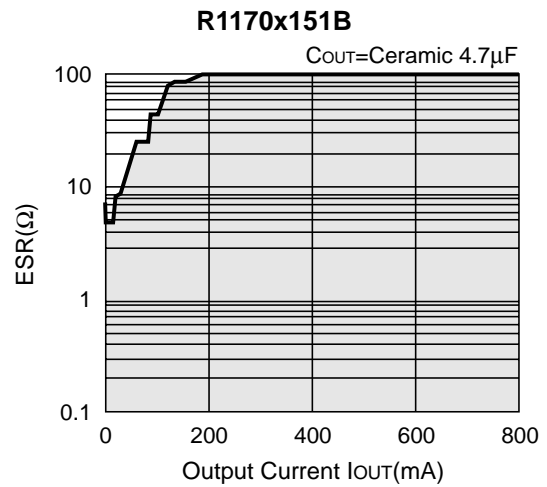
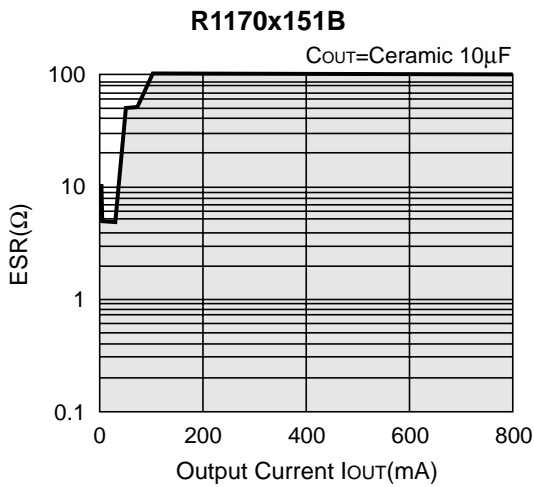

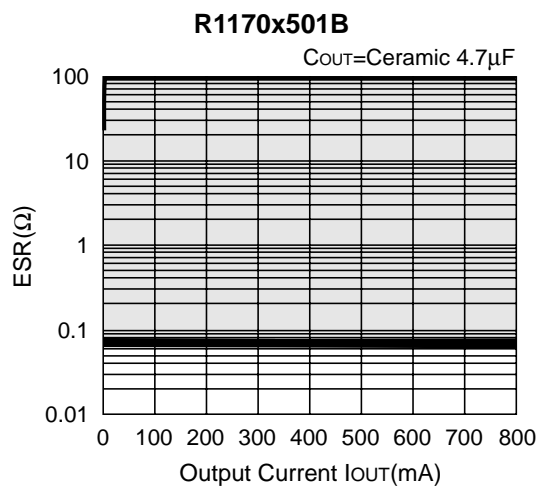
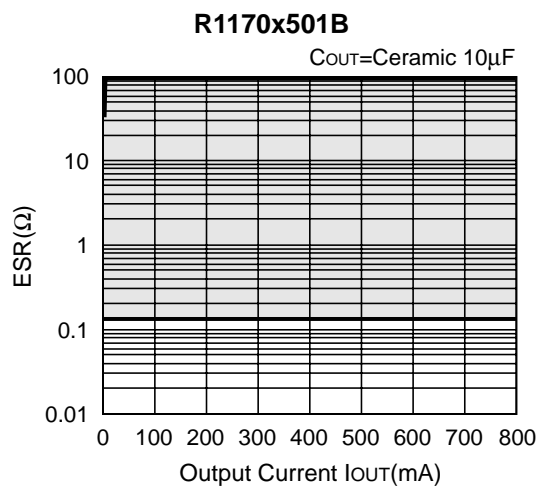



1. The products and the product specifications described in this document are subject to change or discontinuation of production without notice for reasons such as improvement. Therefore, before deciding to use the products, please refer to Ricoh sales representatives for the latest information thereon.
2. The materials in this document may not be copied or otherwise reproduced in whole or in part without prior written consent of Ricoh.
3. Please be sure to take any necessary formalities under relevant laws or regulations before exporting or otherwise taking out of your country the products or the technical information described herein.
4. The technical information described in this document shows typical characteristics of and example application circuits for the products. The release of such information is not to be construed as a warranty of or a grant of license under Ricoh's or any third party's intellectual property rights or any other rights.
5. The products listed in this document are intended and designed for use as general electronic components in standard applications (office equipment, telecommunication equipment, measuring instruments, consumer electronic products, amusement equipment etc.). Those customers intending to use a product in an application requiring extreme quality and reliability, for example, in a highly specific application where the failure or misoperation of the product could result in human injury or death (aircraft, spacevehicle, nuclear reactor control system, traffic control system, automotive and transportation equipment, combustion equipment, safety devices, life support system etc.) should first contact us.
6. We are making our continuous effort to improve the quality and reliability of our products, but semiconductor products are likely to fail with certain probability. In order to prevent any injury to persons or damages to property resulting from such failure, customers should be careful enough to incorporate safety measures in their design, such as redundancy feature, fire containment feature and fail-safe feature. We do not assume any liability or responsibility for any loss or damage arising from misuse or inappropriate use of the products.
7. Anti-radiation design is not implemented in the products described in this document.
8. The X-ray exposure can influence functions and characteristics of the products. Confirm the product functions and characteristics in the evaluation stage.
9. WLCSP products should be used in light shielded environments. The light exposure can influence functions and characteristics of the products under operation or storage.
10. There can be variation in the marking when different AOI (Automated Optical Inspection) equipment is used. In the case of recognizing the marking characteristic with AOI, please contact Ricoh sales or our distributor before attempting to use AOI.
11. Please contact Ricoh sales representatives should you have any questions or comments concerning the products or the technical information.



**Ricoh is committed to reducing the environmental loading materials in electrical devices with a view to contributing to the protection of human health and the environment.**

Ricoh has been providing RoHS compliant products since April 1, 2006 and Halogen-free products since April 1, 2012.

**RICOH** RICOH ELECTRONIC DEVICES CO., LTD.

<https://www.e-devices.ricoh.co.jp/en/>

#### Sales & Support Offices

##### **Ricoh Electronic Devices Co., Ltd.**

##### **Shin-Yokohama Office (International Sales)**

2-3, Shin-Yokohama 3-chome, Kohoku-ku, Yokohama-shi, Kanagawa, 222-8530, Japan  
Phone: +81-50-3814-7687 Fax: +81-45-474-0074

##### **Ricoh Americas Holdings, Inc.**

675 Campbell Technology Parkway, Suite 200 Campbell, CA 95008, U.S.A.  
Phone: +1-408-610-3105

##### **Ricoh Europe (Netherlands) B.V.**

##### **Semiconductor Support Centre**

Prof. W.H. Keesomlaan 1, 1183 DJ Amstelveen, The Netherlands  
Phone: +31-20-5474-309

##### **Ricoh International B.V. - German Branch**

##### **Semiconductor Sales and Support Centre**

Oberrather Strasse 6, 40472 Düsseldorf, Germany  
Phone: +49-211-6546-0

##### **Ricoh Electronic Devices Korea Co., Ltd.**

3F, Haesung Bldg, 504, Teheran-ro, Gangnam-gu, Seoul, 135-725, Korea  
Phone: +82-2-2135-5700 Fax: +82-2-2051-5713

##### **Ricoh Electronic Devices Shanghai Co., Ltd.**

Room 403, No.2 Building, No.690 Bibo Road, Pu Dong New District, Shanghai 201203,  
People's Republic of China  
Phone: +86-21-5027-3200 Fax: +86-21-5027-3299

##### **Ricoh Electronic Devices Shanghai Co., Ltd.**

##### **Shenzhen Branch**

1205, Block D (Jinlong Building), Kingkey 100, Hongbao Road, Luohu District,  
Shenzhen, China  
Phone: +86-755-8348-7600 Ext 225

##### **Ricoh Electronic Devices Co., Ltd.**

##### **Taipei office**

Room 109, 10F-1, No.51, Hengyang Rd., Taipei City, Taiwan (R.O.C.)  
Phone: +886-2-2313-1621/1622 Fax: +886-2-2313-1623

# Mouser Electronics

Authorized Distributor

Click to View Pricing, Inventory, Delivery & Lifecycle Information:

## Ricoh Electronics:

[R1170D191B-TR-FE](#) [R1170S191B-E2-FE](#) [R1170D331B-TR-FE](#) [R1170S331B-E2-FE](#) [R1170H301B-T1-FE](#)  
[R1170D261B-TR-FE](#) [R1170S241B-E2-FE](#) [R1170H251B-T1-FE](#) [R1170H501B-T1-FE](#) [R1170H251A-T1-FE](#)  
[R1170H441B-T1-FE](#) [R1170H151B-T1-FE](#) [R1170H201B-T1-FE](#) [R1170D181B-TR-FE](#) [R1170H381B-T1-FE](#)  
[R1170H371B-T1-FE](#) [R1170D251B-TR-FE](#) [R1170H161B-T1-FE](#) [R1170D151B-TR-FE](#) [R1170S161B-E2-FE](#)  
[R1170S181B-E2-FE](#) [R1170S251B-E2-FE](#) [R1170S261B-E2-FE](#) [R1170S301B-E2-FE](#) [R1170S501B-E2-FE](#)  
[R1170H261B-T1-FE](#) [R1170H281B-T1-FE](#) [R1170H341B-T1-FE](#) [R1170H351B-T1-FE](#) [R1170H421B-T1-FE](#)  
[R1170S151B-E2-FE](#) [R1170D371B-TR-FE](#) [R1170D381B-TR-FE](#) [R1170D421B-TR-FE](#) [R1170D501B-TR-FE](#)  
[R1170H181A-T1-FE](#) [R1170H191B-T1-FE](#) [R1170D301A-TR-FE](#) [R1170D301B-TR-FE](#) [R1170D311B-TR-FE](#)  
[R1170D321B-TR-FE](#) [R1170D331A-TR-FE](#) [R1170D341B-TR-FE](#) [R1170D161B-TR-FE](#) [R1170D271B-TR-FE](#)  
[R1170D281A-TR-FE](#) [R1170D281B-TR-FE](#) [R1170D291A-TR-FE](#) [R1170D291B-TR-FE](#)