

LOC
E

DIST
B

REVISIONS

P	LTR	DESCRIPTION	DATE	DWN	APVD
C	2	REVISED PER ECO-11-005150	29MAR2011	RK	HMR
N		ECR-16-003725	12MAR2016	KR	TN

LASER MARKING: TE LOGO PN VALUE
TOLERANCE & DATE CODE

2xØ3.3 HOLES

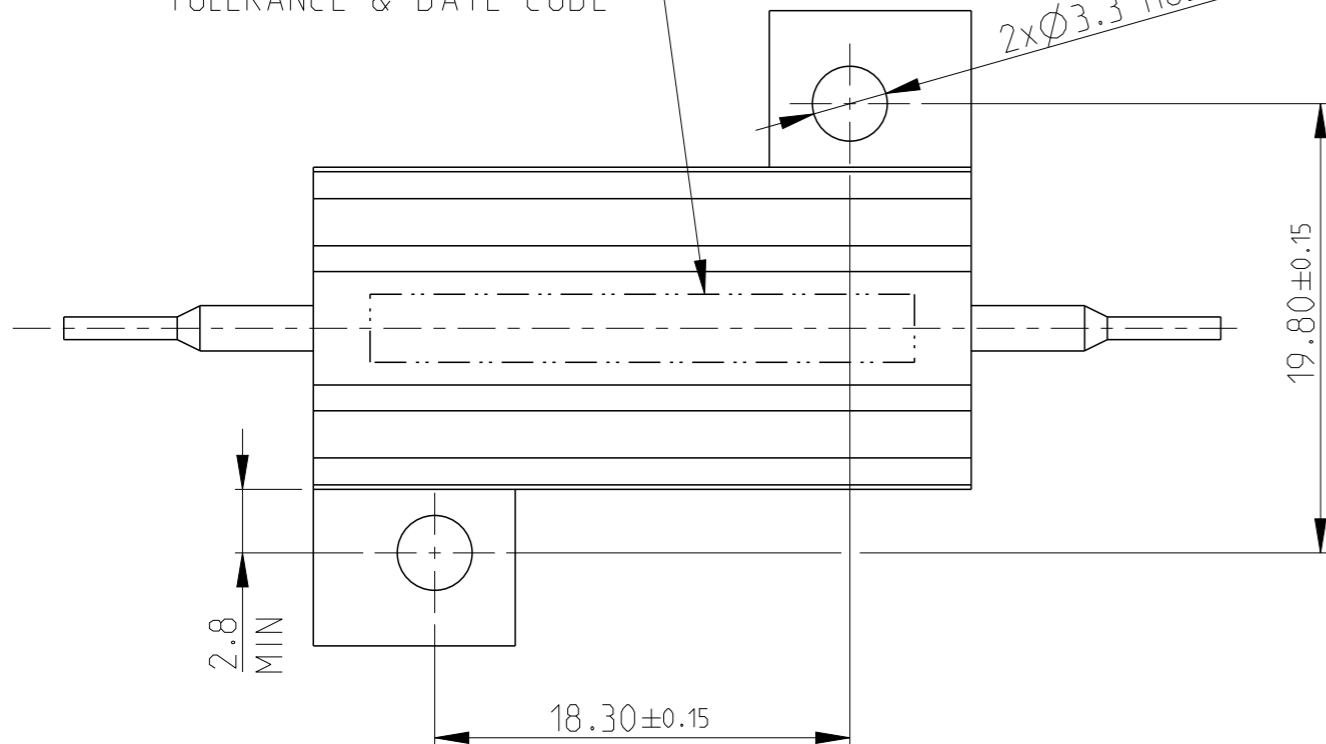

1 FOR FURTHER INFORMATION SEE DATA SHEET FOR
HS SERIES-ALUMINIUM HOUSED RESISTORS

2 FOR A SPECIFIC PN FOR A RESISTANCE VALUE
AND TOLERANCE, PLEASE REFER TO DMF

3 TECHNICAL SPECIFICATION

DISSIPATION AT 25°C : 25 WATTS MOUNTED
ON STANDARD HEATSINK

BS OHMIC RANGE : R051 TO 27K

STABILITY : ΔR < =1% PER 1000hrs

ISOLATION VOLTAGE : 2500V DC/AC pk

MAX WORKING VOLTAGE : 500V DC/AC rms

TEMP COEFFICIENT : > 1R0 50ppm
> 100R 25ppm

CLIMATIC CATEGORY : 55/200/56

TAG HOLES Ø2/2.2

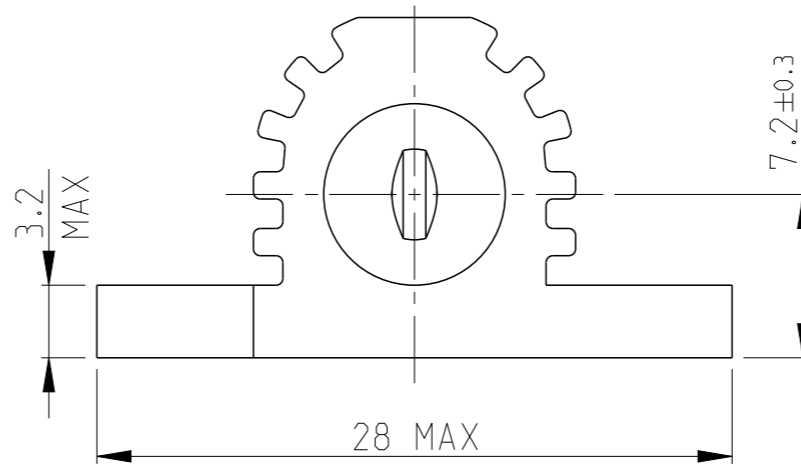
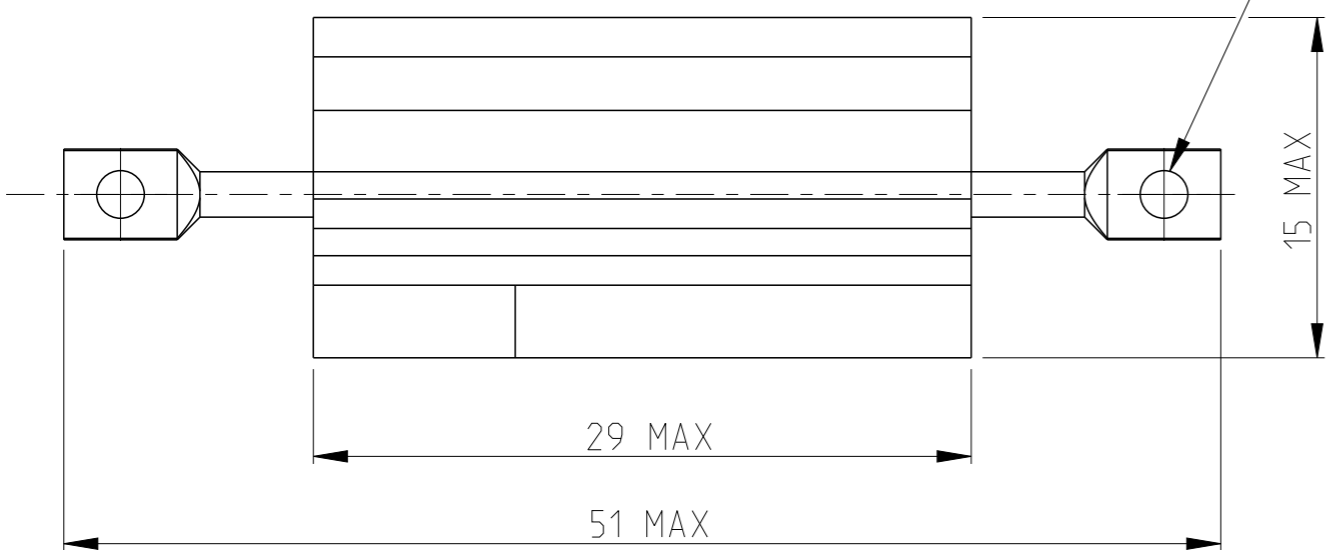

RoHS Compliant



THIS DRAWING IS A CONTROLLED DOCUMENT.

DWN 29.SEP.05
DAVE KENNEDY

CHK 30.SEP.05
J CATCHPOLE

APVD 30.SEP.05
J CATCHPOLE

PRODUCT SPEC

APPLICATION SPEC

WEIGHT

CUSTOMER DRAWING



TE Connectivity

NAME
HSA25 METAL CLAD RESISTOR

SIZE CAGE CODE DRAWING NO RESTRICTED TO

A3 00779 C=1625971

SCALE 3:1 SHEET 1 OF 1 REV N

DIMENSIONS:

mm

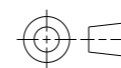

TOLERANCES UNLESS OTHERWISE SPECIFIED:

0 PLC	±0.5
1 PLC	±0.2
2 PLC	±0.1
3 PLC	±
4 PLC	±
ANGLES	±5°
FINISH	-

MATERIAL

-

FINISH

-

Mouser Electronics

Authorized Distributor

Click to View Pricing, Inventory, Delivery & Lifecycle Information:

[TE Connectivity:](#)

[HSA25120RJ](#)