

## Data sheet | Item number: 2273-205

COMPACT splicing connector; for solid conductors; max. 2.5 mm<sup>2</sup>; 5-conductor; transparent housing; yellow cover; Surrounding air temperature: max 60°C (T60); 2,50 mm<sup>2</sup>; transparent

[www.wago.com/2273-205](http://www.wago.com/2273-205)

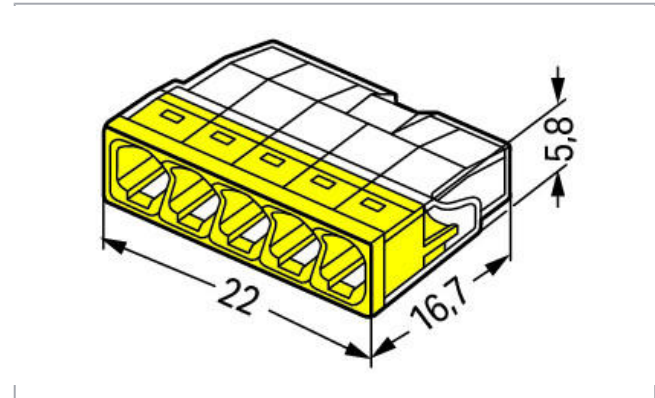

### Item description

Advantages:

- Convenient wiring via an extremely compact design
- Push-in termination of up to eight solid conductors
- Cross-section range: 0.5 ... 2.5 mm<sup>2</sup>
- Any combination of conductor sizes is possible
- PUSH WIRE® connection terminates solid ("s") copper conductors

### Note:

#### Terminating Aluminum Conductors

WAGO spring clamp terminal blocks are suitable for solid aluminum conductors up to 4 mm<sup>2</sup>/12 AWG if WAGO "Alu-Plus" Contact Paste is used for termination.

"Alu-Plus" Contact Paste Advantages:

- Automatically destroys the oxide film during clamping.
- Prevents fresh oxidation at the clamping point.
- Prevents electrolytic corrosion between aluminum and copper conductors (in the same terminal block).
- Provides long-term protection against corrosion.

Subject to changes. Please also observe the further product documentation!

WAGO Kontakttechnik GmbH & Co. KG  
Hansastr. 27  
32423 Minden  
Phone: +49571 887-0 | Fax: +49571 887-169  
Email: [info.de@wago.com](mailto:info.de@wago.com) | Web: [www.wago.com](http://www.wago.com)

Do you have any questions about our products?  
We are always happy to take your call at +49 (571) 887-44222.



For spring clamp connections with PUSH WIRE® connection technology, **WAGO recommends that the aluminum conductor first be cleaned and then immediately inserted into the clamping unit filled with "Alu-Plus" contact paste.**

It is also possible to apply WAGO "Alu-Plus" **additionally** on the whole surface of the aluminum conductor before termination.

Please note that the nominal currents must be adapted to the reduced conductivity of the aluminum conductors::

2.5 mm<sup>2</sup> = 16 A

4 mm<sup>2</sup> = 22 A

**Safety information 1:**

in grounded power lines

## Data

### Electrical data

#### Ratings per IEC/EN 60664-1

Ratings per	IEC/EN 60664-1
Nominal voltage (II/2)	450 V
Rated surge voltage (II/2)	4 kV
Rated current	24 A
Legend (ratings)	(II / 2) ≙ Overvoltage category II / Pollution degree 2

### Connection data

Connection technology	PUSH WIRE®
Actuation type	Push-in
Connectable conductor materials	Copper Aluminum
Solid conductor	0.5 ... 2.5 mm <sup>2</sup> / 20 ... 16 AWG
Strip length	11 mm / 0.43 inch
Total number of connection points	5
Total number of potentials	1
Wiring type	Side-entry wiring

### Physical data

Width	22 mm / 0.866 inch
Height	5.8 mm / 0.228 inch
Depth	16.7 mm / 0.657 inch

Subject to changes. Please also observe the further product documentation!

## Material data

Color	yellow
Cover color	yellow
Flammability class per UL94	V2
Fire load	0.03 MJ
Weight	1.6 g

## Environmental requirements

Surrounding air temperature (operation)	60 °C
Continuous operating temperature	105 °C
Temperature marking per EN 60998	T60

## Commercial data



Product Group	7 (Push Wire Conn.)
Packaging type	BOX
Country of origin	DE
GTIN	4050821027874
Customs tariff number	85369010000

## Approvals / Certificates

### Country specific Approvals

Logo	Approval	Additional Approval Text	Certificate name
	<b>VDE</b> VDE Prüf- und Zertifizierungsinstitut	EN 60998	40029794

### Ship Approvals

Logo	Approval	Additional Approval Text	Certificate name
	<b>ABS</b> American Bureau of Shipping	-	15- HG1419918- PDA
	<b>DNV GL</b> Det Norske Veritas, Germanischer Lloyd	EN 60998	TAE000015T

Subject to changes. Please also observe the further product documentation!



LR  
Lloyds Register

EN 60998

04/20013  
(E8)

## Compatible products

### General accessories



Item no.: 249-130  
Syringe; Contents: 20 ml Alu-Plus contact paste

[www.wago.com/249-130](http://www.wago.com/249-130)

### Mounting adapter



Item no.: 2273-500  
Mounting carrier; for single- and double-row con.; 2273 Series; for DIN-35 rail mounting/screw mounting; orange

[www.wago.com/2273-500](http://www.wago.com/2273-500)

## Downloads

### Documentation

#### Bid Text

2273-205 X81 - Datei	Feb 19, 2019	xml 3.2 kB	Download
2273-205 doc - Datei	May 17, 2017	doc 25.1 kB	Download

#### Additional Information

Technical explanations	Apr 3, 2019	pdf 2.2 MB	Download
------------------------	-------------	---------------	----------

## CAD/CAE-Data

### CAE data

EPLAN Data Portal 2273-205	URL	Download
WSCAD Universe 2273-205	URL	Download
ZUKEN Portal 2273-205	URL	Download

### CAD data

2D/3D Models 2273-205	URL	Download
-----------------------	-----	----------

Subject to changes. Please also observe the further product documentation!

WAGO Kontakttechnik GmbH & Co. KG  
Hansastr. 27  
32423 Minden  
Phone: +49571 887-0 | Fax: +49571 887-169  
Email: [info.de@wago.com](mailto:info.de@wago.com) | Web: [www.wago.com](http://www.wago.com)

Do you have any questions about our products?  
We are always happy to take your call at +49 (571) 887-44222.

## Installation Notes

### Conductor termination

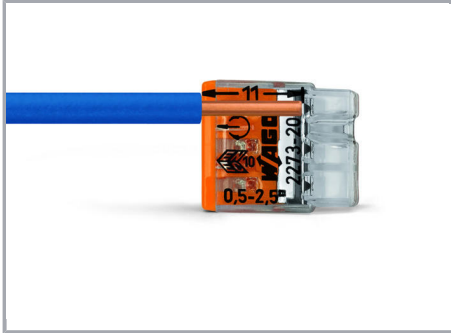

Strip solid conductor to 11 mm / 0.43 inch (see marking).

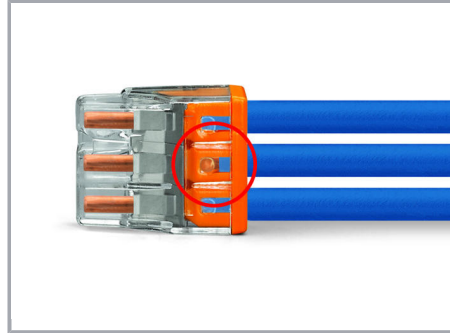

The transparent housing shows if conductors are fully inserted; within the colored base, a clear port shows if the conductor's strip length is correct.

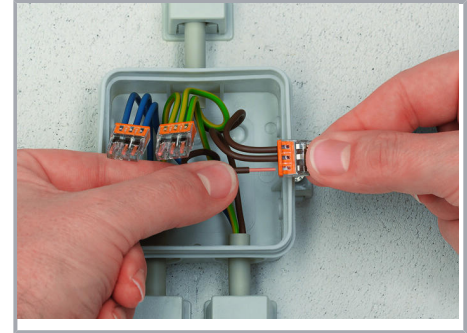

Termination: Insert stripped solid conductor until it hits backstop.

Conductors are correctly stripped if the clear port shows no bare conductor on the unprinted connector side. Picture shows center conductor with exceeded strip length.

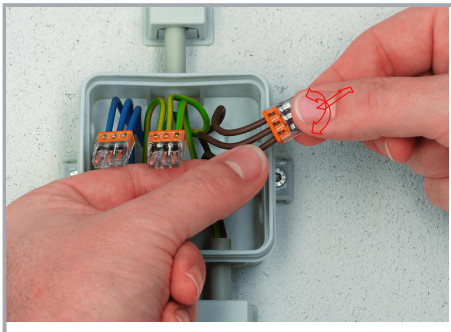

Removal: Hold conductor to be removed and twist alternately left and right while pulling the connector.

### Testing

Subject to changes. Please also observe the further product documentation!



Testing via test port opposite to conductor entry.

Subject to changes. Please also observe the further product documentation!