

Frontplattenausschnitt (Rückseite)
Panel cut out (rear side)

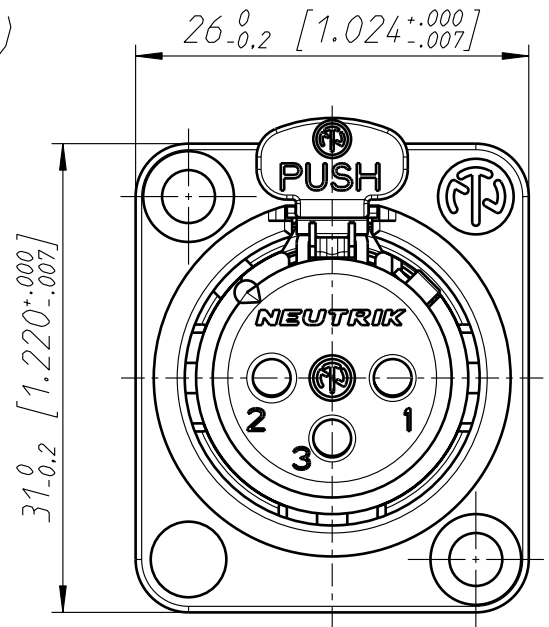
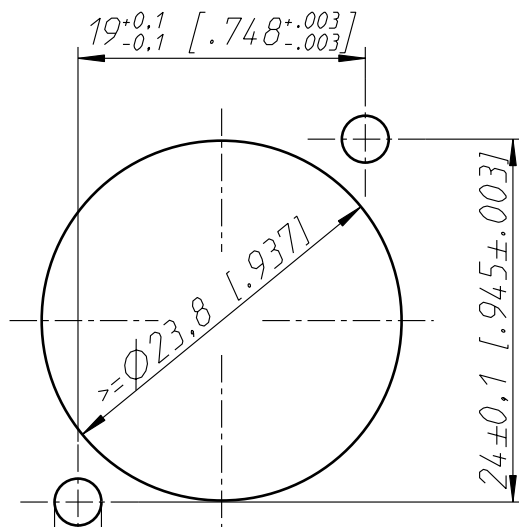

Ø3,1 [1.22]

Allgemeintoleranzen ISO 2768-m	Werkstoff -	Massstab: 2:1 (A4)	Gezeichnet	Datum	Name
			Freigegeben	-	-
Zeichnung urheberrechtlich geschuetzt (DIN 34) (C)	-		Geändert	11.12.07	Mijatovic
			Aend.-Nr.	-	Aend.-Index A
Benennung NA3FDM NA3FDM			Ersatz fuer:	Blatt 1 von 1 Bl.	
			Zeichn. Nr.	ST-NA3FDM	
NEUTRIK AG FL-9494 SCHAAN					