

- CYLINDRICAL V-CHIP CONSTRUCTION FOR SURFACE MOUNTING
- HIGH TEMPERATURE RANGE (+125°C)
- LONG LIFE (UP to 3,000 HOURS)
- LOW ESR, HIGH RIPPLE CURRENT & LOW LEAKAGE
- 6.3x6.3 ~ 10x12.8mm CASE SIZES
- REFLOW SOLDERING RATED TO +260°C (ALL SIZES)
- **MEETS THE REQUIREMENTS OF AEC-Q200***

**NEW
HIGH TEMPERATURE
&
LONG LIFE**

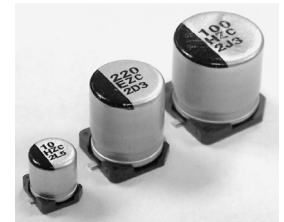

*Contact NIC for supporting test data

CHARACTERISTICS

Rated Voltage Range	16 ~ 40Vdc				
Rated Capacitance Range	18 ~ 560µF				
Operating Temp. Range	-55 ~ +125°C				
Capacitance Tolerance	±20% (M)				
Max. Leakage Current After 2 Minutes @ 20°C	Less than 0.01CV or 3µA whichever is greater				
Working and Surge Voltage Ratings	W.V. (Vdc)	16	25	35	40
	S.V. (Vdc)	20	32	44	50
Tan δ @ 120Hz/20°C		0.16			
Low Temperature Stability Impedance Ratio @ 100KHz	Z-55°C/Z+25°C	0.75 ~ 1.25			
	Z+125°C/Z+20°C	0.75 ~ 1.25			
Load Life Test @ +125°C and Rated Voltage	W.V. (Ved)	16	25	35	40
	φ6.3 Dia.	1500	φ6.3X6.3: 1500, φ6.3X8: 2000		
	φ8 & φ10 Dia.	2500	3000		
	Capacitance Change	Within ±30% of initial measured value			
	Tan δ	Less than 200% of specified max. value			
	ESR	Less than 200% of specified max. value			
	Leakage Current	Less than specified max. value			

STANDARD PRODUCTS AND CASE SIZES Dφ x L (mm)

PART NUMBER	Case Size (D X L) mm	Cap. (µF)	Working Voltage	Max. Tan δ 120Hz/20°C	Max. ESR (mΩ) @ 100KHz/20°C	Max. Ripple Current (mA rms) @ 100KHz/125°C	Load Life Hours (+125°C)
NSPE-TZ820M16V6.3X6.3NBYF	6.3X6.3	82	16	0.16	38	1320	1500
NSPE-TZ121M16V6.3X8NBYF	6.3X8	120		0.16	32	1440	1500
NSPE-TZ271M16V8X10.8NBYF	8X10.8	270		0.16	23	1970	2500
NSPE-TZ471M16V10X10.8NBYF	10X10.8	470		0.16	18	2620	2500
NSPE-TZ561M16V10X12.8NBYF	10X12.8	560		0.16	14	3030	2500
NSPE-TZ470M25V6.3X6.3NBYF	6.3X6.3	47	25	0.16	40	1260	1500
NSPE-TZ680M25V6.3X8NBYF	6.3X8	68		0.16	35	1380	2000
NSPE-TZ151M25V8X10.8NBYF	8X10.8	150		0.16	25	1880	3000
NSPE-TZ271M25V10X10.8NBYF	10X10.8	270		0.16	19	2500	3000
NSPE-TZ331M25V10X12.8NBYF	10X12.8	330		0.16	14	2890	3000
NSPE-TZ270M35V6.3X6.3NBYF	6.3X6.3	27	35	0.16	50	1070	1500
NSPE-TZ470M35V6.3X8NBYF	6.3X8	47		0.16	45	1280	2000
NSPE-TZ101M35V8X10.8NBYF	8X10.8	100		0.16	28	1780	3000
NSPE-TZ151M35V10X10.8NBYF	10X10.8	150		0.16	20	2440	3000
NSPE-TZ221M35V10X12.8NBYF	10X12.8	220		0.16	15	2800	3000
NSPE-TZ180M40V6.3X6.3NBYF	6.3X6.3	18	40	0.16	55	1050	1500
NSPE-TZ270M40V6.3X8NBYF	6.3X8	27		0.16	48	1230	2000
NSPE-TZ560M40V8X10.8NBYF	8X10.8	56		0.16	30	1710	3000
NSPE-TZ101M40V10X10.8NBYF	10X10.8	100		0.16	21	2360	3000
NSPE-TZ121M40V10X12.8NBYF	10X12.8	120		0.16	16	2700	3000

RIPPLE CURRENT FREQUENCY CORRECTION FACTOR

Frequency	120Hz	1KHz	10KHz	≥100KHz
C ≤ 4.7	0.03	0.30	0.65	1.00
4.7 < C ≤ 33	0.05	0.32	0.67	1.00
33 < C	0.10	0.35	0.70	1.00



PART NUMBER SYSTEM

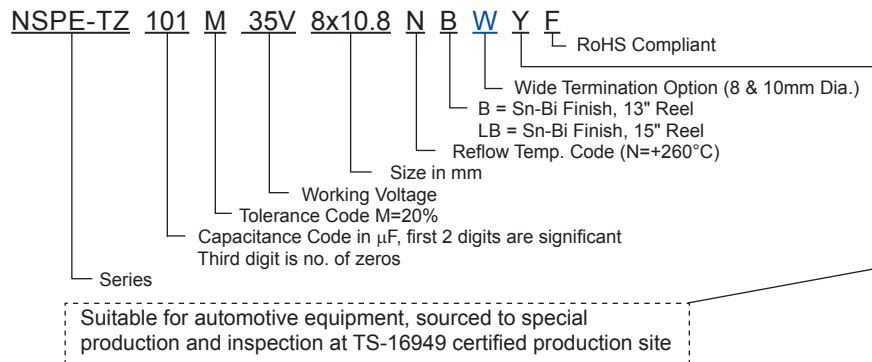

DIMENSIONS (mm)

Case Size	D ϕ ± 0.5	L max.	A, B ± 0.2	W	I ± 0.3	P ± 0.2
6.3x6.3	6.3	6.3	6.6	0.5 ~ 0.8	2.5	2.2
6.3x8	6.3	8	6.6	0.5 ~ 0.8	2.5	2.2
8x10.8	8	10.8	8.3	0.7 ~ 1.0	2.9	3.2
10x10.8	10	10.8	10.3	1.0 ~ 1.4	3.2	4.6
10x12.8	10	12.8	10.3	1.0 ~ 1.4	3.2	4.6

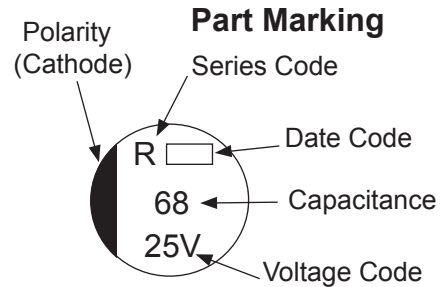
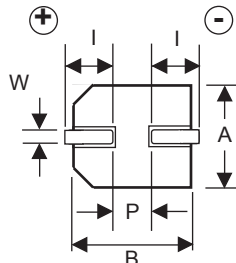
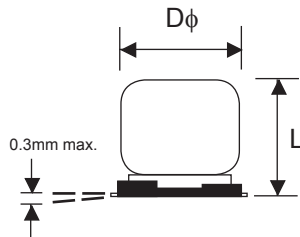

LAND PATTERN DIM. (mm)

Case Dia.	a	b	c
6.3	1.8	3.6	1.8
8	2.8	4.1	2.1
10	4.3	4.4	2.5

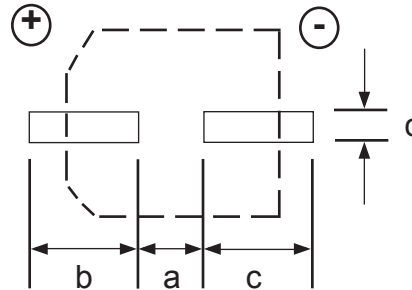

W (WIDE TERMINATIONS) COMPONENT DIM. (mm)

Case Size	D ϕ ± 0.5	L max.	A, B ± 0.2	C ± 0.2	P	W	R	T
8x10.8	8.0	11.2	8.3	9.0	(3.2)	0.7 ~ 1.0	(0.7)	(1.3)
10x10.8	10.0	11.2	10.3	11.0	(4.6)	1.0 ~ 1.4	(0.7)	(1.3)
10x12.8	10.0	13.5	10.3	11.0	(4.6)	1.0 ~ 1.4	(0.7)	(1.3)

(Reference dimensions)

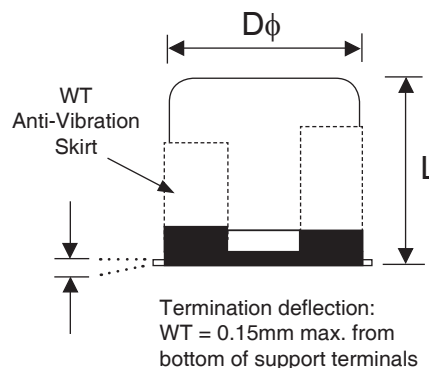
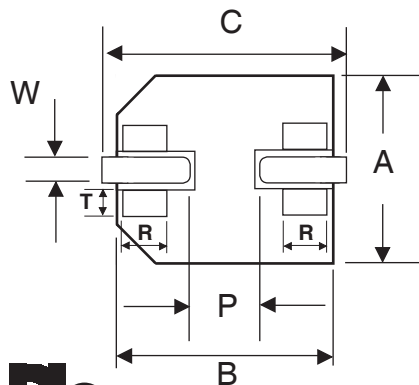

W (WIDE TERMINATIONS) LAND PATTERN DIM. (mm)

Case Size	a	b	c
8x10.8	2.5	4.5	4.7
10x10.8	3.8	4.8	4.7
10x12.8	3.8	4.8	4.7

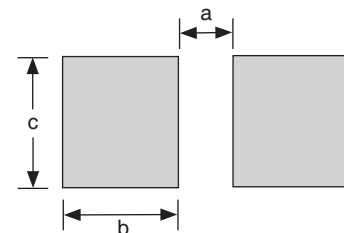

RECOMMENDED REFLOW SOLDERING PROFILE*

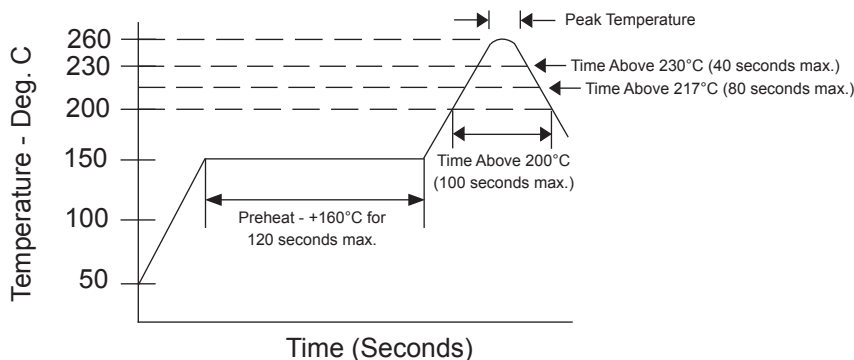

PEAK TEMPERATURE AND DURATION

Diameter	Peak Temperature (5 seconds max.)	Time above 230°C	Time above 217°C	Time above 200°C
φ6.3 ~ 10mm	+260°C	40 sec. max.	80 sec. max.	100 sec. max.

*Two reflow passes are permissible with a cool down to room temperature required between the first and second pass. Acceptable soldering methods are IR or IR & heated air.

Resistance to Soldering Heat	Capacitors placed on a +250°C hot plate for 30 seconds with their electrode terminals facing downward will fulfill the following conditions after being cooled to room temperature	
	Capacitance Change	Within ± 10% of the initial measured value
	Dissipation Factor	Less than maximum specified value
	Leakage Current	Less than maximum specified value
	ESR	Less than 130% of maximum specified value

TAPING SPECIFICATIONS (mm)

- Both Leader and Trailer tape: Minimum 40mm (1.57") empty carrier tape pockets.
- Leader tape: Approximately 20cm of cover tape at leader.
- Connection: Maximum 3 connections (slices) per reel.

Case Size	A ±0.5	B ±0.5	C ±0.3	D ±0.1	P ±0.1	T ±0.2	t max.
6.3x6.3	7.0	7.0	16.0	7.5	12.0	6.5	0.6
6.3x8	7.0	7.0	16.0	7.5	12.0	8.2	0.6
8x10.8	8.7	8.7	24.0	11.5	16.0	11.1	0.6
10x10.8	10.7	10.7	24.0	11.5	16.0	11.2	0.6
10x12.8	10.7	10.7	24.0	11.5	16.0	13.3	0.6

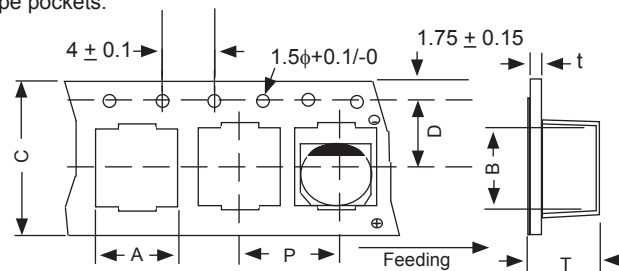

REEL DIMENSIONS (mm)

Case Size	W ±1.0	Qty per Reel	
		13" (330mm)	15" (380mm)
6.3x6.3	18	800	1,000
6.3x8	18	500	900
8x10.8	26	300	500
10x10.8	26	300	500
10x12.8	26	300	400

