

# LUXEON 3014

High efficacy compact package,  
designed for high quality light output

LUXEON 3014 has a compact package size of 3.0mm x 1.4mm x 0.70mm—ideal for achieving uniform light output where space is limited, such as linear applications, tube lighting, and signage. LUXEON 3014 is hot-color targeted at a junction temperature of 65°C, ensuring color consistency and meeting ANSI standards at operating conditions.



## FEATURES AND BENEFITS

Compact package design affirms uniformity and reduction in spottiness

Hot-color targeting ensures better color control

1/9<sup>th</sup> ANSI micro-color binning enables tight color control

120mA maximum driving current allows outstanding brightness

## PRIMARY APPLICATIONS

Wall Grazer

Linear

Wall Wash

Sconce

Downlights

# Table of Contents

<b>General Product Information</b> .....	<b>2</b>
Product Test Conditions .....	2
Part Number Nomenclature .....	2
Lumen Maintenance .....	2
Environmental Compliance .....	2
<b>Performance Characteristics</b> .....	<b>3</b>
Product Selection Guide .....	3
Optical Characteristics .....	3
Electrical and Thermal Characteristics .....	4
<b>Absolute Maximum Ratings</b> .....	<b>4</b>
<b>Characteristic Curves</b> .....	<b>5</b>
Spectral Power Distribution Characteristics .....	5
Forward Current Characteristics .....	8
Radiation Pattern Characteristics .....	9
<b>Product Bin and Labeling Definitions</b> .....	<b>10</b>
Decoding Product Bin Labeling .....	10
Luminous Flux Bins .....	10
Color Bin Definitions .....	11
Forward Voltage Bins .....	17
<b>Mechanical Dimensions</b> .....	<b>17</b>
<b>Reflow Soldering Guidelines</b> .....	<b>18</b>
JEDEC Moisture Sensitivity .....	18
Solder Pad Design .....	19
<b>Packaging Information</b> .....	<b>19</b>
Pocket Tape Dimensions .....	19
Reel Dimensions .....	20

# General Product Information

## Product Test Conditions

LUXEON 3014 LEDs are tested with a 20ms monopulse of 60mA at a junction temperature,  $T_j$ , of 25°C. Forward voltage and luminous flux are binned at a  $T_j$  of 25°C, while color is not targeted at a  $T_j$  of 65°C.

## Part Number Nomenclature

Part numbers for LUXEON 3014 follow the convention below:

L 1 3 0 – **A A B B C C** 1 4 0 0 0 0 **D**

Where:

- A A** – designates nominal CCT (22=2200K, 25=2500K, 27=2700K, 30=3000K, 35=3500K, 40=4000K, 50=5000K, 57=5700K, 65=6500K, 80=8000K, 10=10000K)
- B B** – designates minimum CRI (70=70CRI, 80=80CRI, 90=90CRI, 95=95CRI)
- C C** – designates platform (HE=high efficacy)
- D** – designates Lumileds internal code (1 is full distribution base part; 2, 3, etc.=shares the same base part)

Therefore, the following part number is used for a LUXEON 3014 3000K 80CRI high efficacy LED:

L 1 3 0 – **3 0 8 0 H E** 1 4 0 0 0 0 **1**

## Lumen Maintenance

Please contact your local Sales Representative or Lumileds Technical Solutions Manager for more information about the long-term performance of this product.

## Environmental Compliance

Lumileds LLC is committed to providing environmentally friendly products to the solid-state lighting market. LUXEON 3014 is compliant to the European Union directives on the restriction of hazardous substances in electronic equipment, namely the RoHS Directive 2011/65/EU and REACH Regulation (EC) 1907/2006. Lumileds LLC will not intentionally add the following restricted materials to its products: lead, mercury, cadmium, hexavalent chromium, polybrominated biphenyls (PBB) or polybrominated diphenyl ethers (PBDE).

# Performance Characteristics

## Product Selection Guide

Table 1. Product performance of LUXEON 3014 at 60mA and 30mA, at specified test conditions.

NOMINAL CCT <sup>[1]</sup>	MINIMUM CRI <sup>[2, 3]</sup>	LUMINOUS FLUX <sup>[3]</sup> (lm)		TYPICAL LUMINOUS EFFICACY (lm/W)	TYPICAL LUMINOUS FLUX <sup>[2]</sup> (lm)	TYPICAL LUMINOUS EFFICACY (lm/W)	PART NUMBER
		MINIMUM	TYPICAL				
		60mA					
8000K	70	25.0	28.0	150	15.0	172	L130-8070001400001
10000K	70	23.0	27.0	145	14.0	166	L130-1070001400001
2200K	80	19.0	22.5	127	12.1	145	L130-2280HE1400001
2500K	80	21.0	25.0	141	13.5	162	L130-2580HE1400001
2700K	80	23.0	26.5	150	14.3	171	L130-2780HE1400001
3000K	80	23.0	28.0	158	15.1	181	L130-3080HE1400001
3500K	80	23.0	28.0	158	15.1	181	L130-3580HE1400001
4000K	80	25.0	29.0	164	15.6	187	L130-4080HE1400001
5000K	80	25.0	29.0	164	15.6	187	L130-5080HE1400001
5700K	80	25.0	29.0	164	15.6	187	L130-5780HE1400001
6500K	80	25.0	28.5	161	15.3	184	L130-6580HE1400001
2200K	90	16.0	19.0	107	10.2	123	L130-2290001400001
2500K	90	16.0	21.0	119	11.3	136	L130-2590001400001
2700K	90	18.0	22.0	124	11.8	142	L130-2790001400001
3000K	90	19.0	23.0	130	12.4	149	L130-3090001400001
3500K	90	19.0	23.5	133	12.6	152	L130-3590001400001
4000K	90	20.0	24.5	138	13.2	158	L130-4090001400001
5000K	90	20.0	24.5	138	13.2	158	L130-5090001400001
5700K	90	20.0	24.5	138	13.2	158	L130-5790001400001
6500K	90	20.0	24.0	136	12.9	155	L130-6590001400001
2200K	95	15.5	17.2	97	9.3	111	L130-2295001400001
2500K	95	18.0	19.7	111	10.6	127	L130-2595001400001
2700K	95	18.0	20.0	113	10.8	129	L130-2795001400001
3000K	95	20.0	22.0	124	11.8	142	L130-3095001400001
3500K	95	20.0	22.0	124	11.8	142	L130-3595001400001
4000K	95	19.5	21.5	121	11.6	139	L130-4095001400001
5000K	95	19.5	21.5	121	11.6	139	L130-5095001400001
5700K	95	19.5	21.5	121	11.6	139	L130-5795001400001

**Notes for Table 1:**

1. Correlated color temperature is not targeted at  $T_j=65^\circ\text{C}$ .
2. Lumileds maintains a tolerance of  $\pm 2$  on CRI and  $\pm 6.5\%$  on luminous flux measurements.
3. Typical CRI is approximately 2 points higher than the minimum CRI specified, but this is not guaranteed.

## Optical Characteristics

Table 2. Optical characteristics for LUXEON 3014 at 60mA,  $T_j=25^\circ\text{C}$ .

PART NUMBER	TYPICAL TOTAL INCLUDED ANGLE <sup>[1]</sup>	TYPICAL VIEWING ANGLE <sup>[2]</sup>
L130-xxxxxx1400001	140°	116°

**Notes for Table 2:**

1. Total angle at which 90% of total luminous flux is captured.
2. Viewing angle is the off axis angle from the LED centerline where the luminous intensity is 1/2 of the peak value.

# Electrical and Thermal Characteristics

Table 3. Electrical and thermal characteristics for LUXEON 3014 at 60mA, T<sub>j</sub>=25°C.

PART NUMBER	FORWARD VOLTAGE <sup>[1]</sup> (V <sub>f</sub> )			TYPICAL TEMPERATURE COEFFICIENT OF FORWARD VOLTAGE <sup>[2]</sup> (mV/°C)	TYPICAL THERMAL RESISTANCE—JUNCTION TO SOLDER PAD (°C/W)
	MINIMUM	TYPICAL	MAXIMUM		
L130-xxxxxx1400001	2.8	2.95	3.3	-2.0 to -4.0	35

**Notes for Table 3:**

1. Lumileds maintains a tolerance of ±0.1V on forward voltage measurements.
2. Measured between 25°C and 85°C.

## Absolute Maximum Ratings

Table 4. Absolute maximum ratings for LUXEON 3014.

PARAMETER	MAXIMUM PERFORMANCE
DC Forward Current <sup>[1,2]</sup>	120mA
Peak Pulsed Forward Current <sup>[1,3]</sup>	150mA
LED Junction Temperature (DC & Pulse) <sup>[1]</sup>	125°C
ESD Sensitivity (ANSI/ESDA/JEDEC JS-001-2012)	Class 2
Operating Case Temperature <sup>[1]</sup>	-40°C to 105°C
LED Storage Temperature	-40°C to 100°C
Soldering Temperature	JEDEC 020D 260°C
Allowable Reflow Cycles	3
Reverse Voltage (V <sub>reverse</sub> ) <sup>[4]</sup>	-5V

**Notes for Table 4:**

1. Proper current derating must be observed to maintain the junction temperature below the maximum allowable junction temperature.
2. Residual periodic variations due to power conversion from alternating current (AC) to direct current (DC), also called "ripple," are acceptable if the following conditions are met:
  - The frequency of the ripple current is 100Hz or higher
  - The average current for each cycle does not exceed the maximum allowable DC forward current
  - The maximum amplitude of the ripple does not exceed 15% of the maximum allowable DC forward current
3. At 10% duty cycle with pulse width of 10ms.
4. At a maximum reverse current of 2µA. LUXEON 3014 LEDs are not designed to be driven in reverse bias.

# Characteristic Curves

## Spectral Power Distribution Characteristics



Figure 1a. Typical normalized power vs. wavelength for L130-xx70001400001 at 60mA,  $T_j=25^{\circ}\text{C}$ .

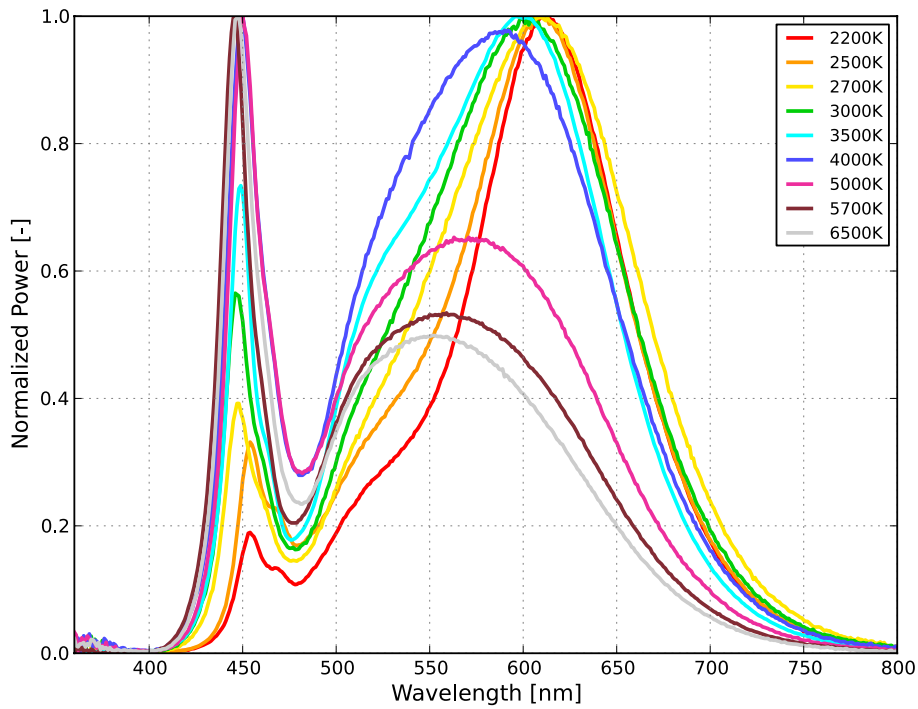

Figure 1b. Typical normalized power vs. wavelength for L130-xx80HE1400001 at 60mA,  $T_j=25^{\circ}\text{C}$ .

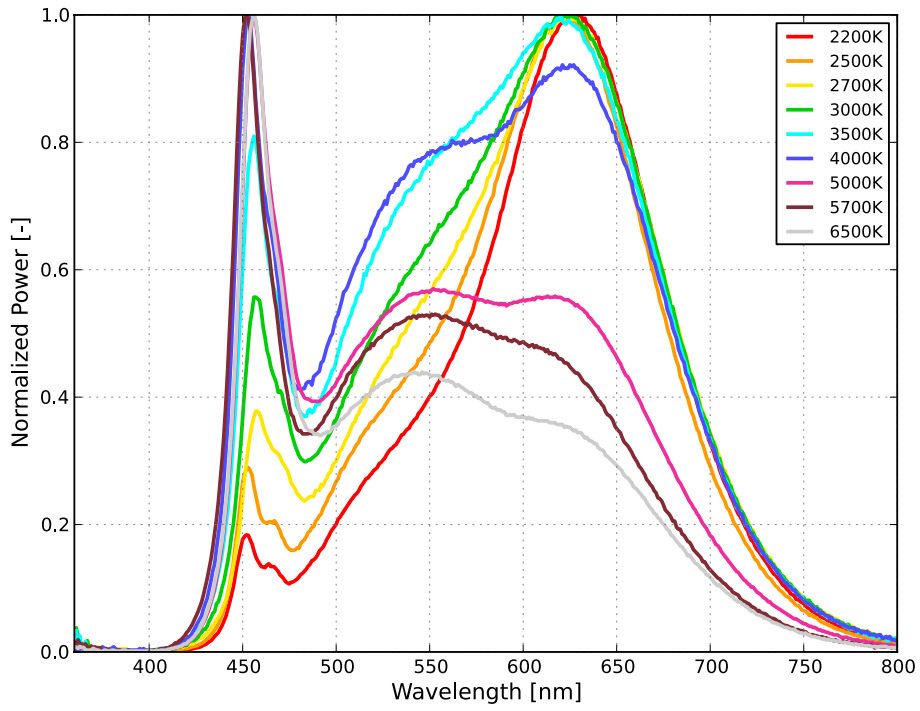

Figure 1c. Typical normalized power vs. wavelength for L130-xx90001400001 at 60mA,  $T_j=25^\circ\text{C}$ .

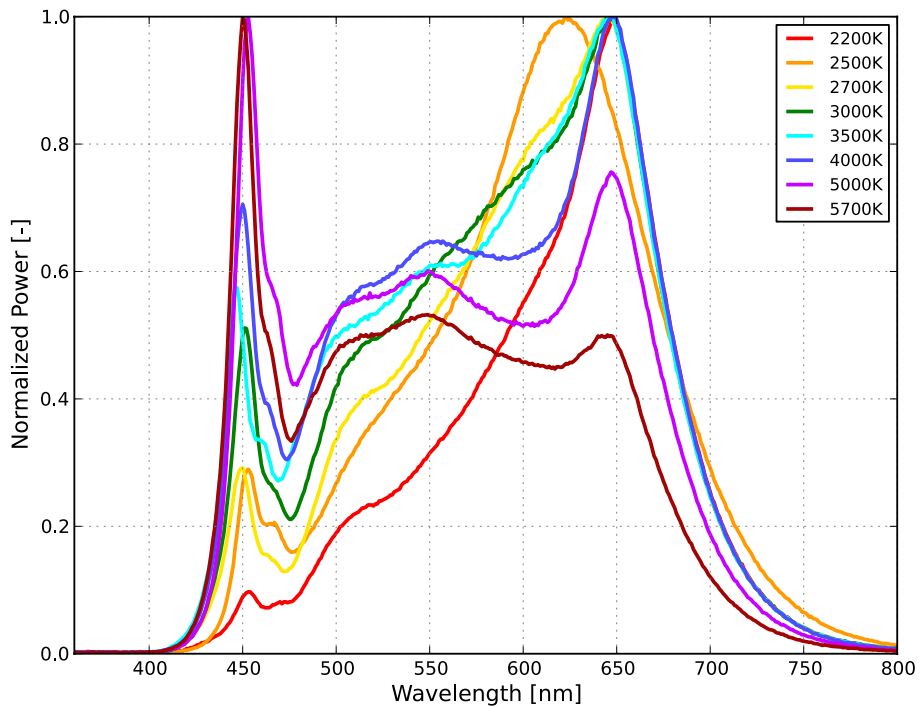

Figure 1d. Typical normalized power vs. wavelength for L130-xx95001400001 at 60mA,  $T_j=25^\circ\text{C}$ .

# Light Output Characteristics

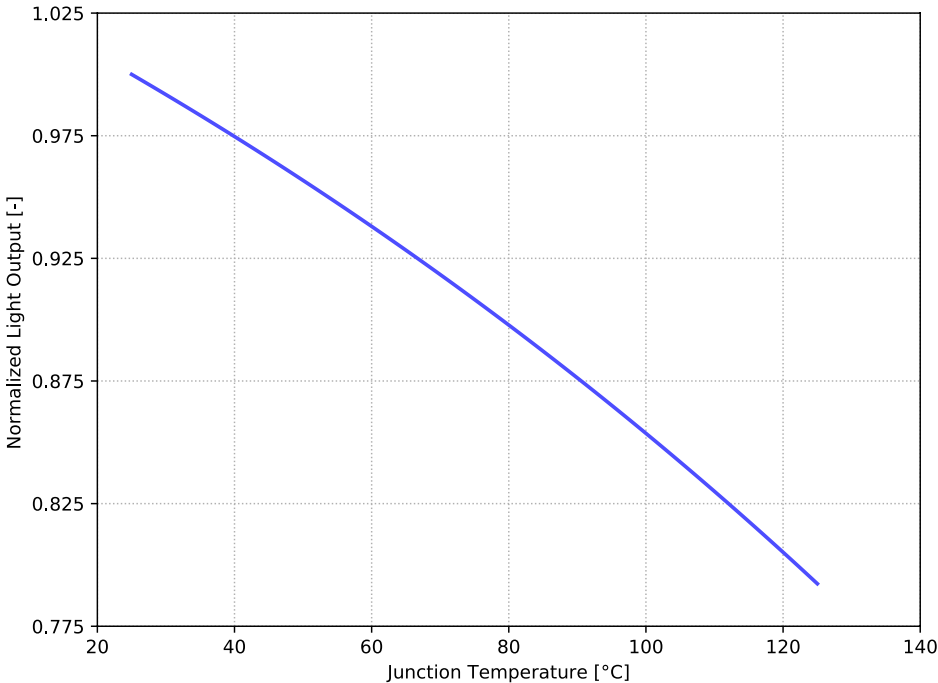

Figure 2. Typical normalized light output vs. junction temperature for L130-xxxxxx1400001 at 60mA.

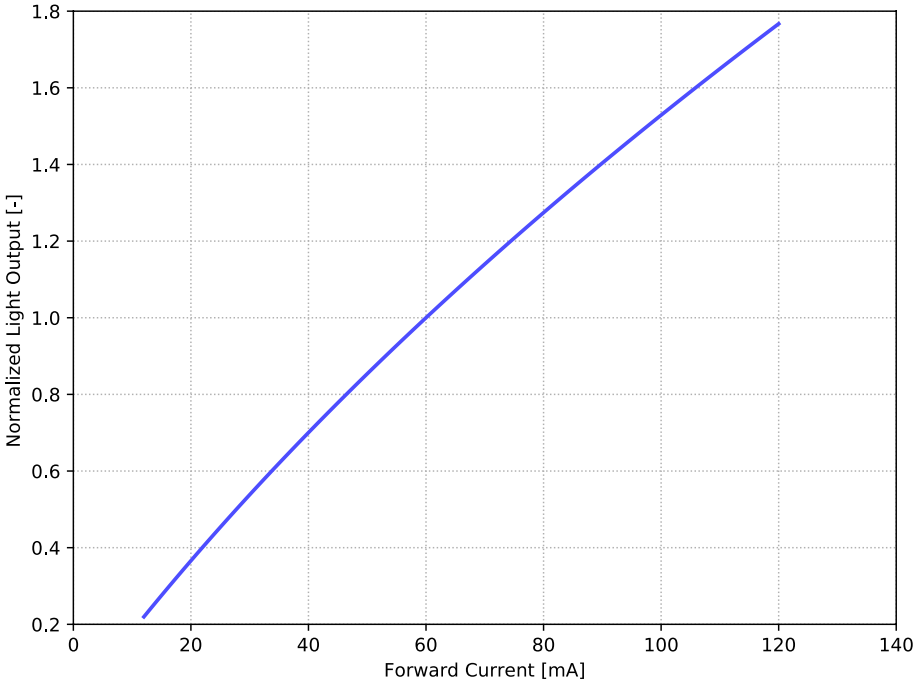

Figure 3. Typical normalized light output vs. forward current for L130-xxxxxx1400001 at  $T_j=25^\circ\text{C}$ .



# Forward Current Characteristics

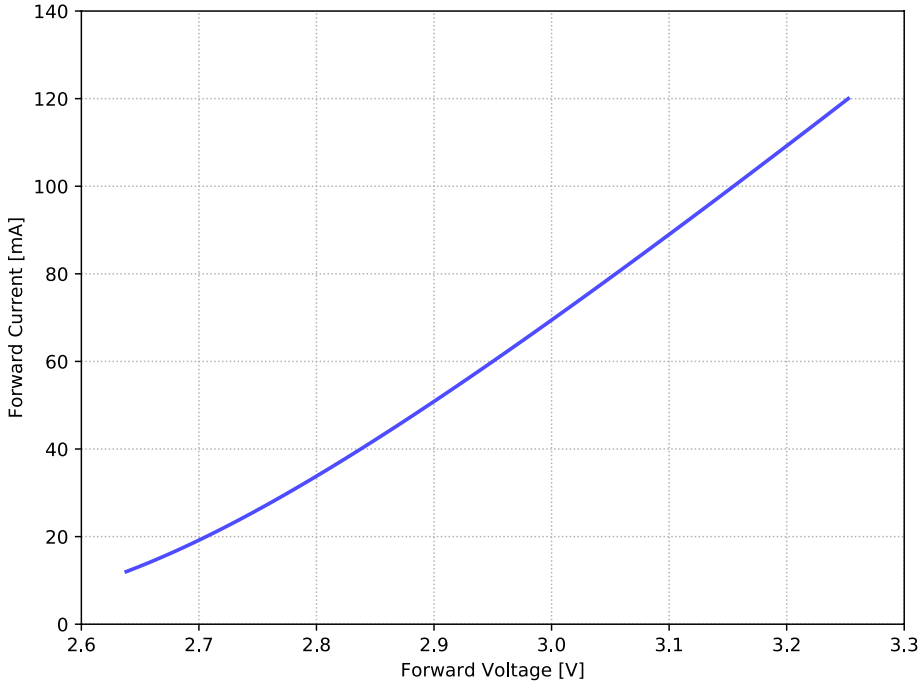

Figure 4. Typical forward current vs. forward voltage for L130-xxxxxx1400001 at  $T_j=25^\circ\text{C}$ .

## Radiation Pattern Characteristics

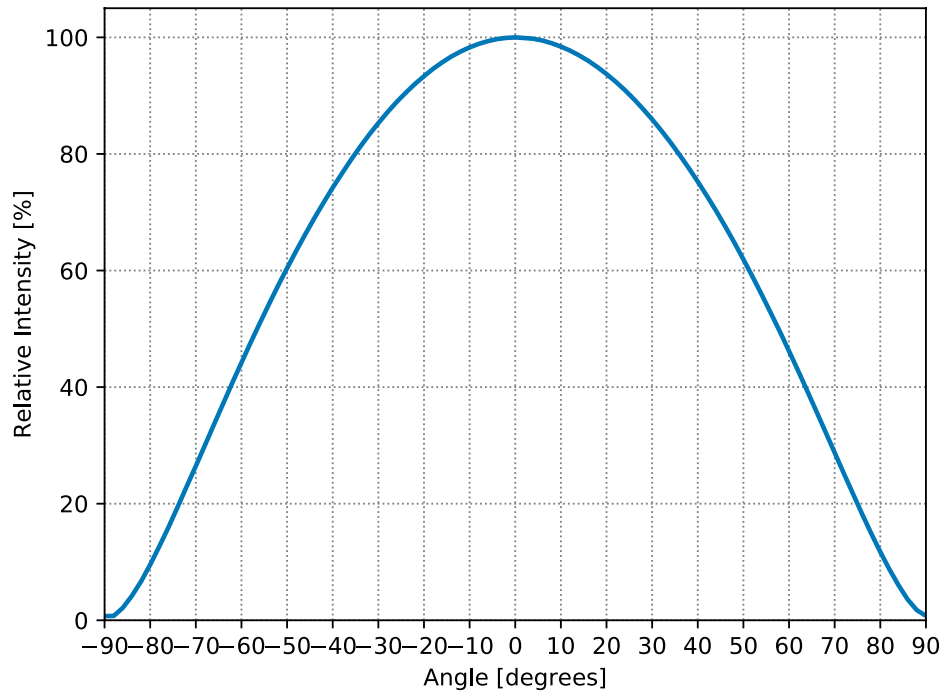

Figure 5. Typical radiation pattern for L130-xxxxxx1400001 at 60mA,  $T_j=25^\circ\text{C}$ .

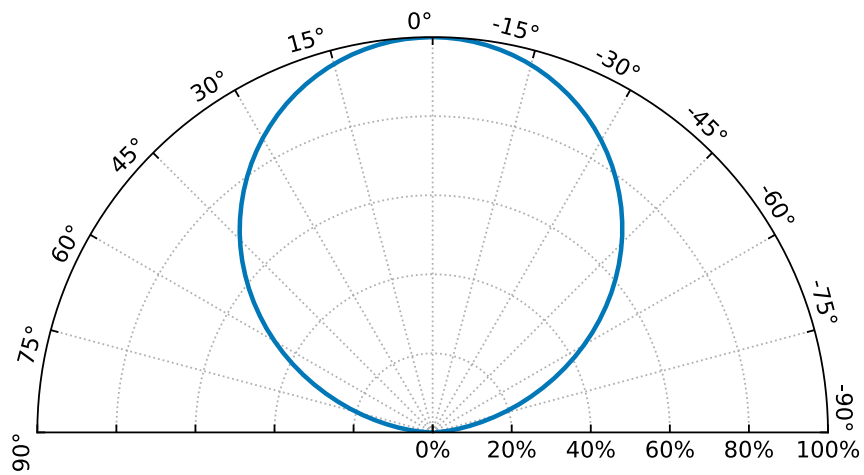

Figure 6. Typical polar radiation pattern for L130-xxxxxx1400001 at 60mA,  $T_j=25^\circ\text{C}$ .

# Product Bin and Labeling Definitions

## Decoding Product Bin Labeling

In the manufacturing of semiconductor products, there are variations in performance around the average values given in the technical datasheet. For this reason, Lumileds bins LED components for luminous flux or radiometric power, color point, peak or dominant wavelength and forward voltage.

LUXEON 3014 LEDs are labeled using a 5-digit alphanumeric CAT code following the format below:

### A x B C D

- A x** – designates luminous flux bin (example: G0=19 to 21 lm, J1=25 to 27 lm)
- B C** – designates color bin (example: 7D, 7E, 7F, 7G, 7H, 7J, 7K, 7L, 7M for 3000K parts)
- D** – designates forward voltage bin (example: T=2.80 to 2.90V, W=3.00 to 3.10V)

Therefore, a LUXEON 3014 with a lumen range of 25 to 27 lm, color bin of 7D and a forward voltage range of 2.80 to 2.90V has the following CAT code:

### J 1 7 D T

## Luminous Flux Bins

Table 5 lists the standard luminous flux bins for LUXEON 3014 emitters. Although several bins are outlined, product availability in a particular bin varies by production run and by product performance. Not all bins are available in all CCTs.

Table 5. Luminous flux bin definitions for LUXEON 3014 at 60mA, T<sub>j</sub>=25°C.

BIN	LUMINOUS FLUX <sup>(1)</sup> (lm)	
	MINIMUM	MAXIMUM
D0	13	15
E0	15	17
F0	17	19
G0	19	21
H1	21	23
H2	23	25
J1	25	27
J2	27	29
K1	29	31
K2	31	33

**Notes for Table 5:**

1. Lumileds maintains a tolerance of ±6.5% on luminous flux measurements.

# Color Bin Definitions

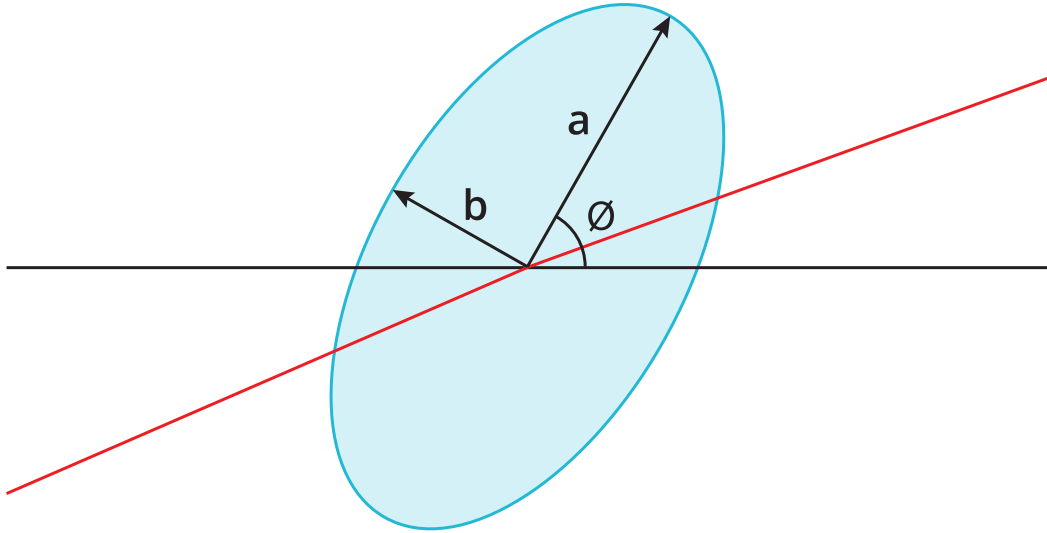

Figure 7. 3-, 4- and 5-step MacAdam ellipse illustration for Tables 6a-6k.

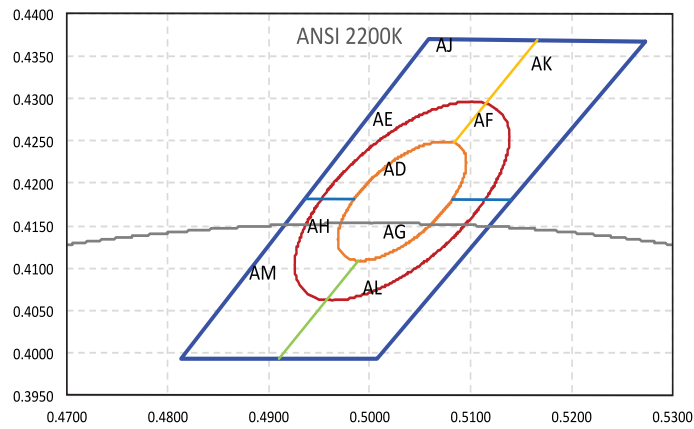

Figure 8a. Color bin structure for LUXEON 3014 2200K, hot-color targeted at  $T_j=65^\circ\text{C}$ .

Table 6a. 3- and 5-step MacAdam ellipse color bin definitions for L130-22xxHE1400001 at 60mA, hot-color targeted at  $T_j=65^\circ\text{C}$ .

NOMINAL CCT	COLOR SPACE	CENTER POINT (cx, cy)	MAJOR AXIS, a	MINOR AXIS, b	ELLIPSE ROTATION ANGLE, $\theta$
2200K	Single 3-step MacAdam ellipse	(0.5037, 0.4142)	0.0072	0.0042	51.0°
2200K	Single 5-step MacAdam ellipse	(0.5037, 0.4142)	0.0120	0.0070	51.0°

**Notes for Table 6a:**

1. Lumileds maintains a tolerance of  $\pm 0.005$  on x and y coordinates in the CIE 1931 color space.

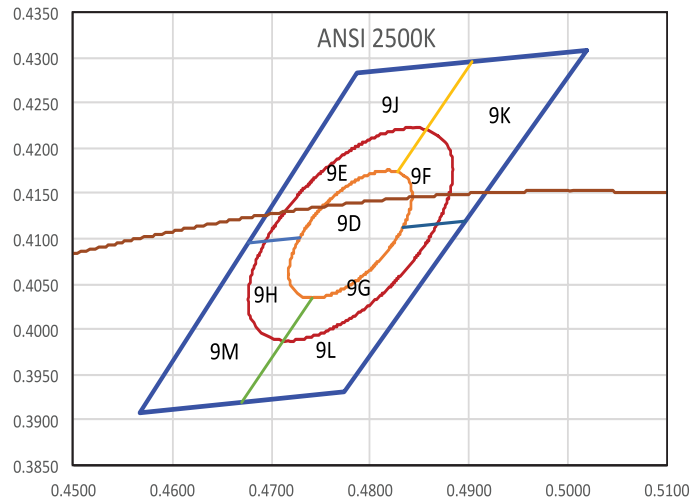

Figure 8b. Color bin structure for LUXEON 3014 2500K, hot-color targeted at  $T_j=65^\circ\text{C}$ .

Table 6b. 3- and 5-step MacAdam ellipse color bin definitions for L130-25xxHE1400001 at 60mA, hot-color targeted at  $T_j=65^\circ\text{C}$ .

NOMINAL CCT	COLOR SPACE	CENTER POINT (cx, cy)	MAJOR AXIS, a	MINOR AXIS, b	ELLIPSE ROTATION ANGLE, $\theta$
2500K	Single 3-step MacAdam ellipse	(0.4753, 0.4127)	0.0075	0.0042	53.0°
2500K	Single 5-step MacAdam ellipse	(0.4753, 0.4127)	0.0125	0.0070	53.0°

Notes for Table 6b:

1. Lumileds maintains a tolerance of  $\pm 0.005$  on x and y coordinates in the CIE 1931 color space.

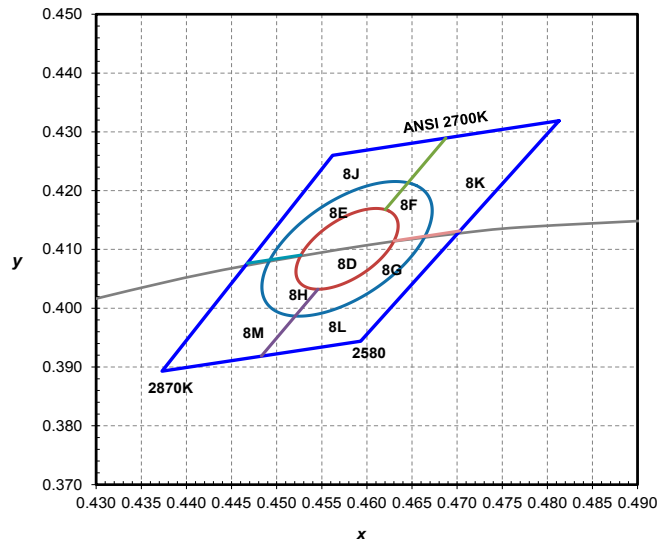

Figure 8c. Color bin structure for LUXEON 3014 2700K, hot-color targeted at  $T_j=65^\circ\text{C}$ .

Table 6c. 3- and 5-step MacAdam ellipse color bin definitions for L130-27xxxx1400001 at 60mA, hot-color targeted at  $T_j=65^\circ\text{C}$ .

NOMINAL CCT	COLOR SPACE	CENTER POINT (cx, cy)	MAJOR AXIS, a	MINOR AXIS, b	ELLIPSE ROTATION ANGLE, $\theta$
2700K	Single 3-step MacAdam ellipse	(0.4578, 0.4101)	0.00810	0.00420	53.70°
2700K	Single 5-step MacAdam ellipse	(0.4578, 0.4101)	0.01350	0.00700	53.70°

Notes for Table 6c:

1. Lumileds maintains a tolerance of  $\pm 0.005$  on x and y coordinates in the CIE 1931 color space.

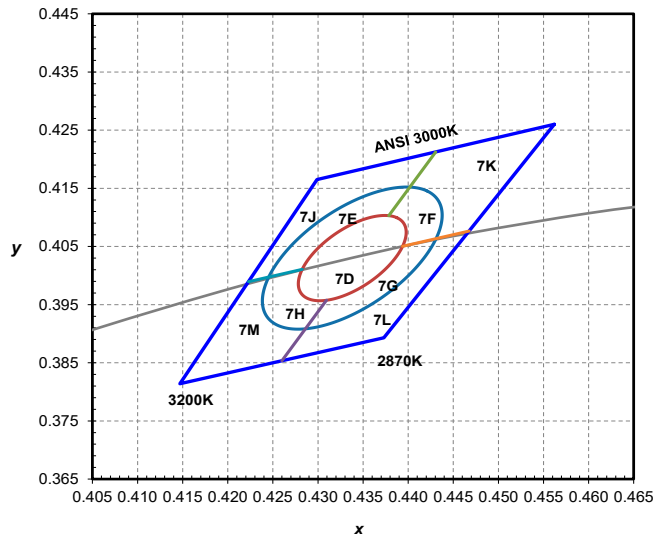

Figure 8d. Color bin structure for LUXEON 3014 3000K, hot-color targeted at  $T_j=65^\circ\text{C}$ .

Table 6d. 3- and 5-step MacAdam ellipse color bin definitions for L130-30xxxx1400001 at 60mA, hot-color targeted at  $T_j=65^\circ\text{C}$ .

NOMINAL CCT	COLOR SPACE	CENTER POINT (cx, cy)	MAJOR AXIS, a	MINOR AXIS, b	ELLIPSE ROTATION ANGLE, $\theta$
3000K	Single 3-step MacAdam ellipse	(0.4338, 0.4030)	0.00834	0.00408	53.22°
3000K	Single 5-step MacAdam ellipse	(0.4338, 0.4030)	0.01390	0.00680	53.22°

Notes for Table 6d:

1. Lumileds maintains a tolerance of  $\pm 0.005$  on x and y coordinates in the CIE 1931 color space.

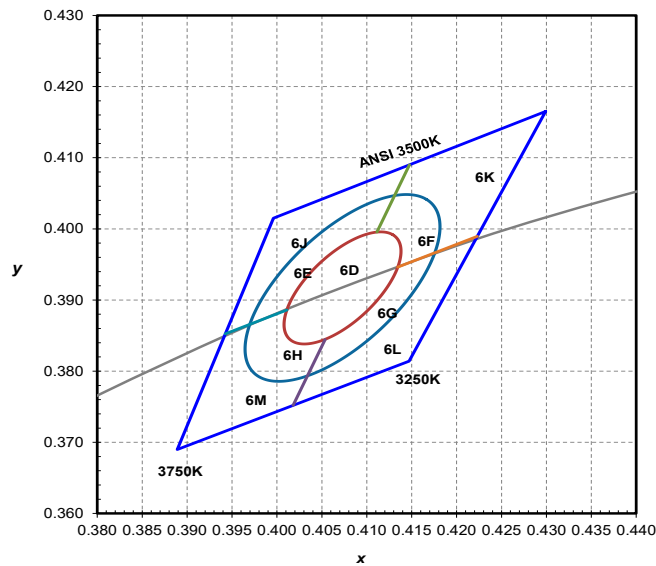

Figure 8e. Color bin structure for LUXEON 3014 3500K, hot-color targeted at  $T_j=65^\circ\text{C}$ .

Table 6e. 3- and 5-step MacAdam ellipse color bin definitions for L130-35xxxx1400001 at 60mA, hot-color targeted at  $T_j=65^\circ\text{C}$ .

NOMINAL CCT	COLOR SPACE	CENTER POINT (cx, cy)	MAJOR AXIS, a	MINOR AXIS, b	ELLIPSE ROTATION ANGLE, $\theta$
3500K	Single 3-step MacAdam ellipse	(0.4073, 0.3917)	0.00927	0.00414	54.00°
3500K	Single 5-step MacAdam ellipse	(0.4073, 0.3917)	0.01545	0.00690	54.00°

Notes for Table 6e:

1. Lumileds maintains a tolerance of  $\pm 0.005$  on x and y coordinates in the CIE 1931 color space.

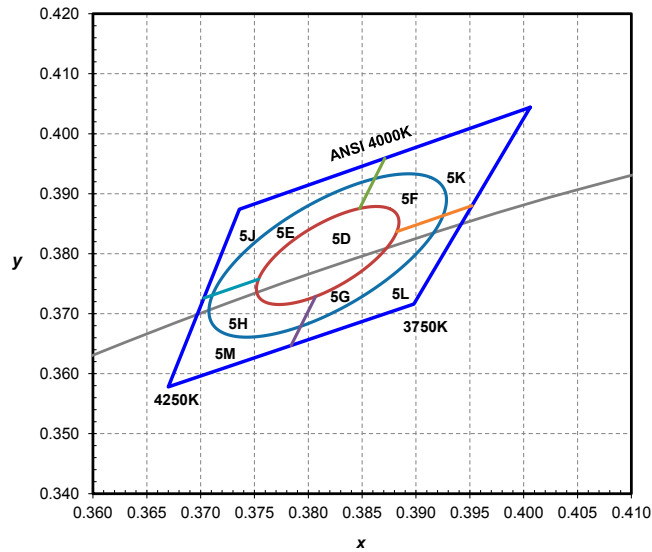

Figure 8f. Color bin structure for LUXEON 3014 4000K, hot-color targeted at  $T_j=65^\circ\text{C}$ .

Table 6f. 3- and 5-step MacAdam ellipse color bin definitions for L130-40xxxx1400001 at 60mA, hot-color targeted at  $T_j=65^\circ\text{C}$ .

NOMINAL CCT	COLOR SPACE	CENTER POINT (cx, cy)	MAJOR AXIS, a	MINOR AXIS, b	ELLIPSE ROTATION ANGLE, $\theta$
4000K	Single 3-step MacAdam ellipse	(0.3818, 0.3797)	0.00939	0.00402	53.72°
4000K	Single 5-step MacAdam ellipse	(0.3818, 0.3797)	0.01565	0.00670	53.72°

Notes for Table 6f:

1. Lumileds maintains a tolerance of  $\pm 0.005$  on x and y coordinates in the CIE 1931 color space.

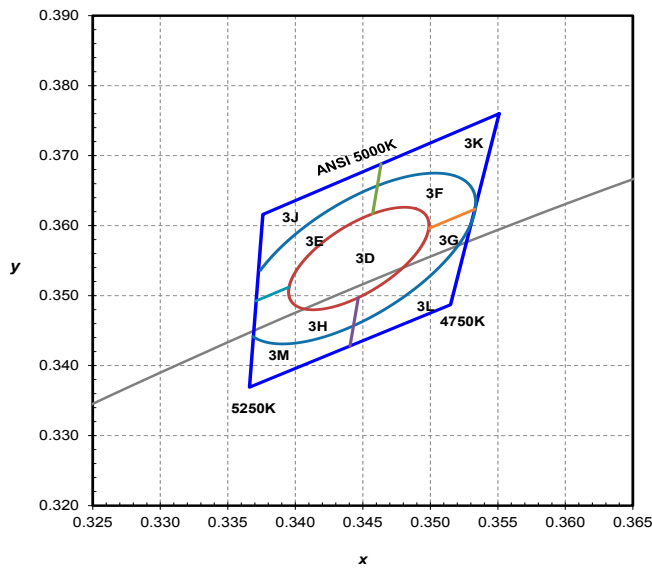

Figure 8g. Color bin structure for LUXEON 3014 5000K, hot-color targeted at  $T_j=65^\circ\text{C}$ .

Table 6g. 3- and 5-step MacAdam ellipse color bin definitions for L130-50xxxx1400001 at 60mA, hot-color targeted at  $T_j=65^\circ\text{C}$ .

NOMINAL CCT	COLOR SPACE	CENTER POINT (cx, cy)	MAJOR AXIS, a	MINOR AXIS, b	ELLIPSE ROTATION ANGLE, $\theta$
5000K	Single 3-step MacAdam ellipse	(0.3447, 0.3553)	0.00822	0.00354	59.62°
5000K	Single 5-step MacAdam ellipse	(0.3447, 0.3553)	0.01370	0.00590	59.62°

Notes for Table 6g:

1. Lumileds maintains a tolerance of  $\pm 0.005$  on x and y coordinates in the CIE 1931 color space.

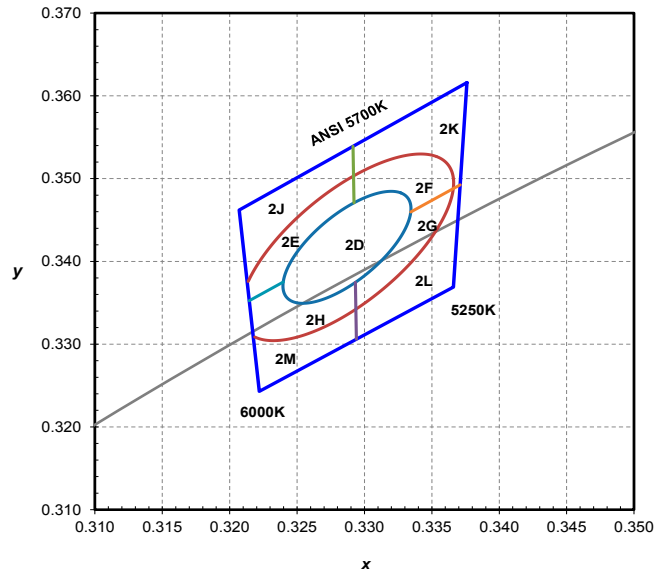

Figure 8h. Color bin structure for LUXEON 3014 5700K, hot-color targeted at  $T_j=65^\circ\text{C}$ .

Table 6h. 3- and 5-step MacAdam ellipse color bin definitions for L130-57xxxx1400001 at 60mA, hot-color targeted at  $T_j=65^\circ\text{C}$ .

NOMINAL CCT	COLOR SPACE	CENTER POINT (cx, cy)	MAJOR AXIS, a	MINOR AXIS, b	ELLIPSE ROTATION ANGLE, $\theta$
5700K	Single 3-step MacAdam ellipse	(0.3287, 0.3417)	0.00746	0.00320	59.09°
5700K	Single 5-step MacAdam ellipse	(0.3287, 0.3417)	0.01243	0.00533	59.09°

Notes for Table 6h:

1. Lumileds maintains a tolerance of  $\pm 0.005$  on x and y coordinates in the CIE 1931 color space.

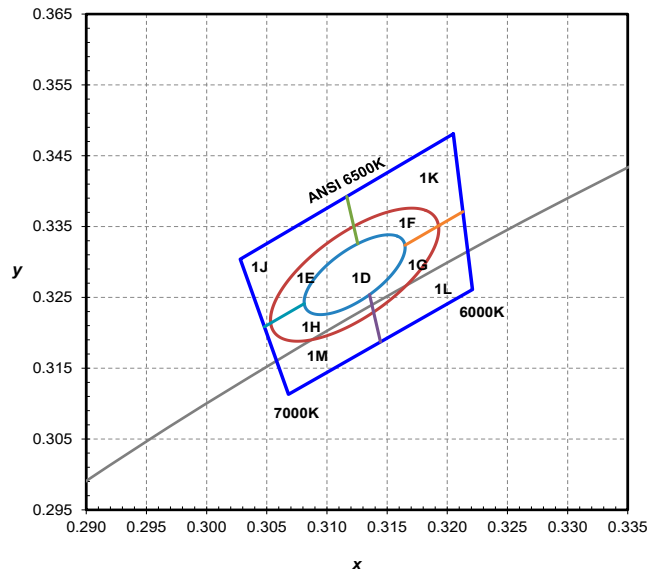

Figure 8i. Color bin structure for LUXEON 3014 6500K, hot-color targeted at  $T_j=65^\circ\text{C}$ .

Table 6i. 3- and 5-step MacAdam ellipse color bin definitions for L130-65xxxx1400001 at 60mA, hot-color targeted at  $T_j=65^\circ\text{C}$ .

NOMINAL CCT	COLOR SPACE	CENTER POINT (cx, cy)	MAJOR AXIS, a	MINOR AXIS, b	ELLIPSE ROTATION ANGLE, $\theta$
6500K	Single 3-step MacAdam ellipse	(0.3123, 0.3282)	0.00669	0.00285	58.57°
6500K	Single 5-step MacAdam ellipse	(0.3123, 0.3282)	0.01115	0.00475	58.57°

Notes for Table 6i:

1. Lumileds maintains a tolerance of  $\pm 0.005$  on x and y coordinates in the CIE 1931 color space.



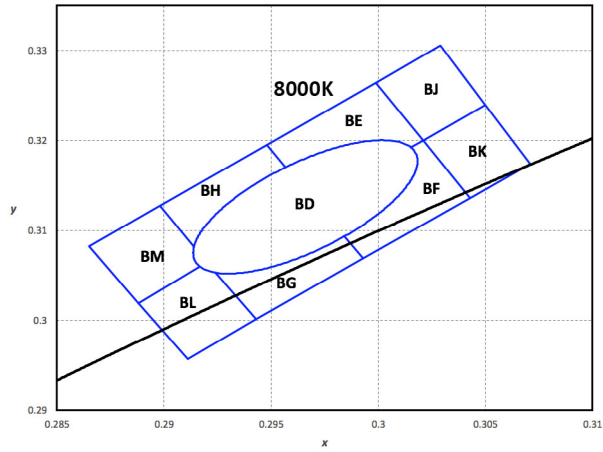

Figure 8j. Color bin structure for LUXEON 3014 8000K, hot-color targeted at  $T_j=65^\circ\text{C}$ .

Table 6j. 4-step MacAdam ellipse color bin definitions for L130-8070001400001 at 60mA, hot-color targeted at  $T_j=65^\circ\text{C}$ .

NOMINAL CCT	COLOR SPACE	CENTER POINT (cx, cy)	MAJOR AXIS, a	MINOR AXIS, b	ELLIPSE ROTATION ANGLE, $\theta$
8000K	Single 4-step MacAdam ellipse	(0.2966, 0.3126)	0.00844	0.00334	58.64°

Notes for Table 6j:

- Lumileds maintains a tolerance of  $\pm 0.005$  on x and y coordinates in the CIE 1931 color space.

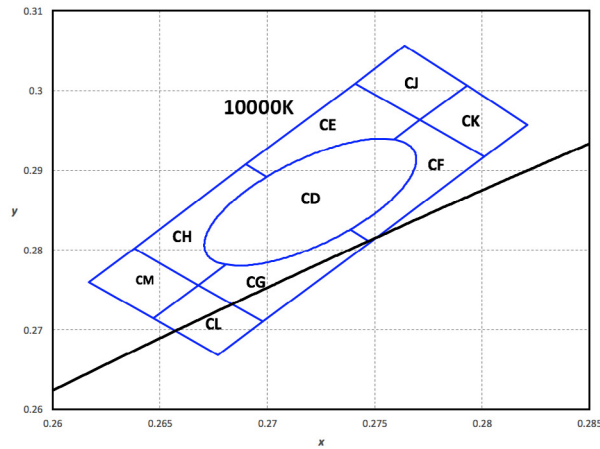

Figure 8k. Color bin structure for LUXEON 3014 10000K, hot-color targeted at  $T_j=65^\circ\text{C}$ .

Table 6k. 4-step MacAdam ellipse color bin definitions for L130-1070001400001 at 60mA, hot-color targeted at  $T_j=65^\circ\text{C}$ .

NOMINAL CCT	COLOR SPACE	CENTER POINT (cx, cy)	MAJOR AXIS, a	MINOR AXIS, b	ELLIPSE ROTATION ANGLE, $\theta$
10000K	Single 4-step MacAdam ellipse	(0.2720, 0.2860)	0.00877	0.00332	63.28°

Notes for Table 6k:

- Lumileds maintains a tolerance of  $\pm 0.005$  on x and y coordinates in the CIE 1931 color space.

# Forward Voltage Bins

Table 7. Forward voltage bin definitions for LUXEON 3014 at 60mA,  $T_j=25^\circ\text{C}$ .

BIN	FORWARD VOLTAGE <sup>(1)</sup> (V <sub>f</sub> )	
	MINIMUM	MAXIMUM
T	2.80	2.90
V	2.90	3.00
W	3.00	3.10
X	3.10	3.20
Y	3.20	3.30
Z	3.30	3.40

**Notes for Table 7:**

1. Lumileds maintains a tolerance of  $\pm 0.1\text{V}$  on forward voltage measurements.

# Mechanical Dimensions

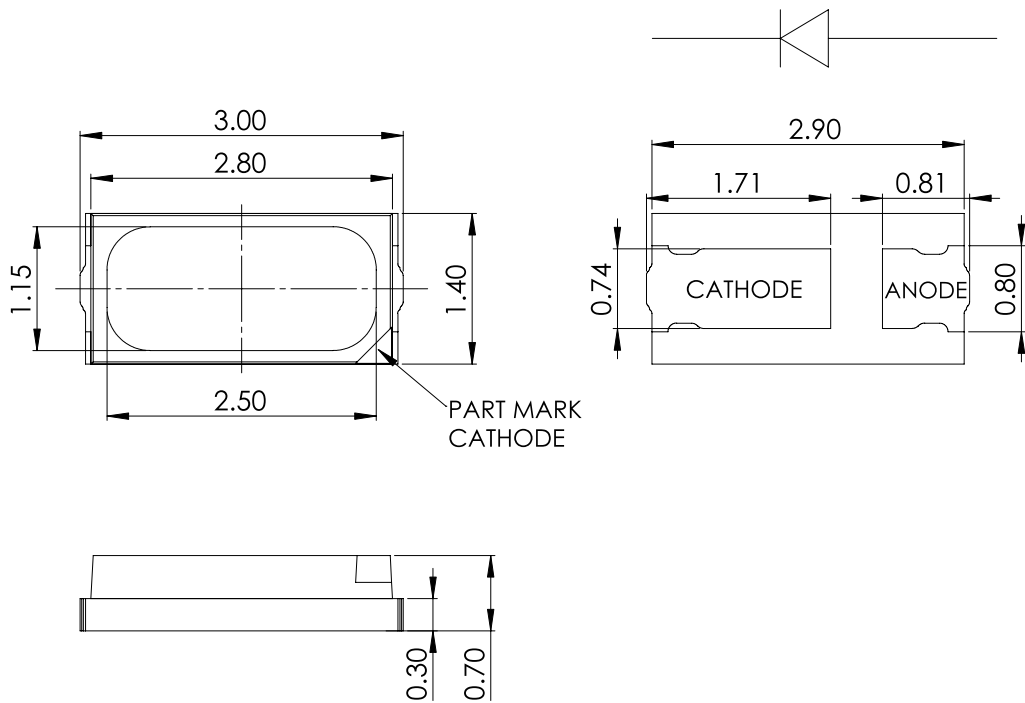

Figure 9. Mechanical dimensions for LUXEON 3014.

**Notes for Figure 9:**

1. Drawings are not to scale.
2. All dimensions are in millimeters.

# Reflow Soldering Guidelines

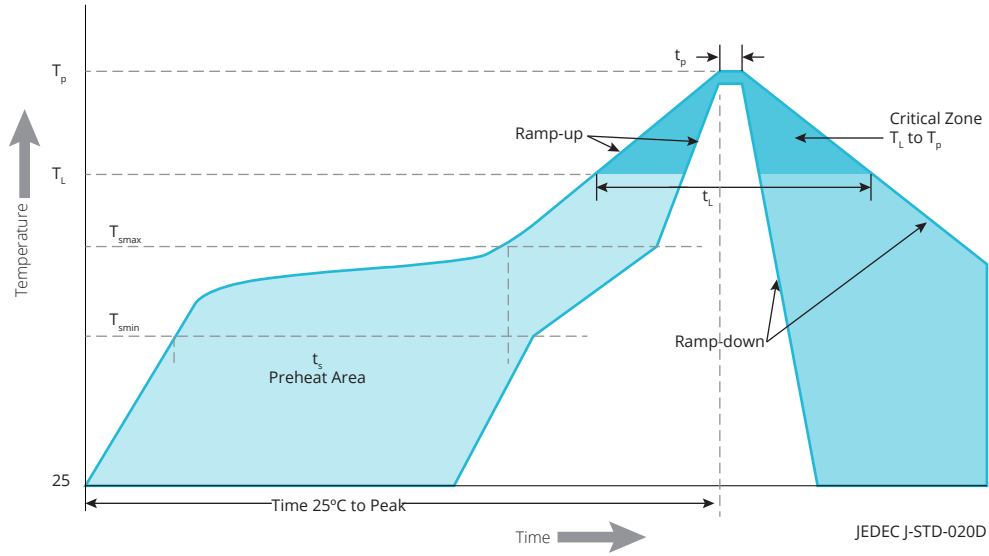

Figure 10. Visualization of the acceptable reflow temperature profile as specified in Table 8.

Table 8. Reflow profile characteristics for LUXEON 3014.

PROFILE FEATURE	LEAD-FREE ASSEMBLY
Preheat Minimum Temperature ( $T_{smin}$ )	150°C
Preheat Maximum Temperature ( $T_{smax}$ )	200°C
Preheat Time ( $t_{smin}$ to $t_{smax}$ )	60 to 120 seconds
Ramp-Up Rate ( $T_L$ to $T_p$ )	3°C / second maximum
Liquidous Temperature ( $T_L$ )	217°C
Time Maintained Above Temperature $T_L$ ( $t_L$ )	60 to 150 seconds
Peak / Classification Temperature ( $T_p$ )	260°C
Time Within 5°C of Actual Peak Temperature ( $t_p$ )	20 to 40 seconds
Ramp-Down Rate ( $T_p$ to $T_L$ )	6°C / second maximum
Time 25°C to Peak Temperature	8 minutes maximum

## JEDEC Moisture Sensitivity

Table 9. Moisture sensitivity levels for LUXEON 3014.

LEVEL	FLOOR LIFE		SOAK REQUIREMENTS STANDARD	
	TIME	CONDITIONS	TIME	CONDITIONS
3	168 Hours	≤30°C / 60% RH	192 Hours +5 / -0	30°C / 60% RH

# Solder Pad Design

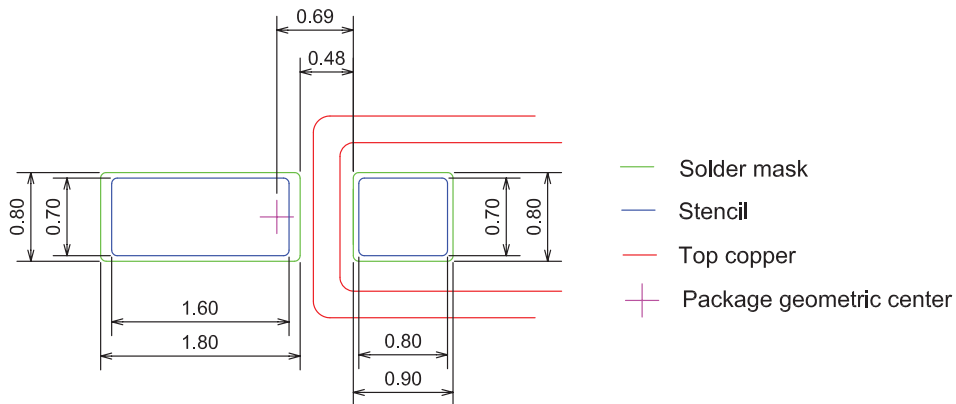

Figure 11. Recommended PCB solder pad layout for LUXEON 3014.

- Notes for Figure 11:
1. Drawings are not to scale.
  2. All dimensions are in millimeters.

# Packaging Information

## Pocket Tape Dimensions

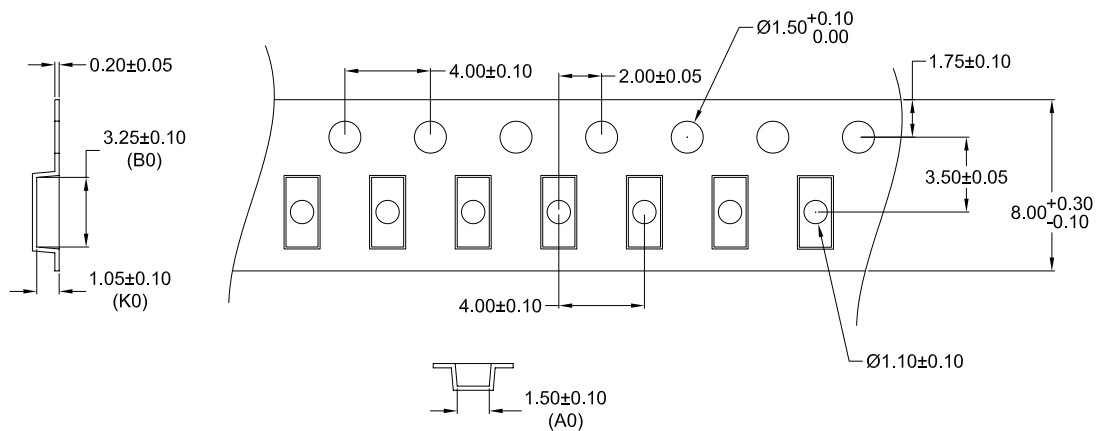

Figure 12. Pocket tape dimensions for LUXEON 3014.

- Notes for Figure 12:
1. Drawings are not to scale.
  2. All dimensions are in millimeters.

# Reel Dimensions

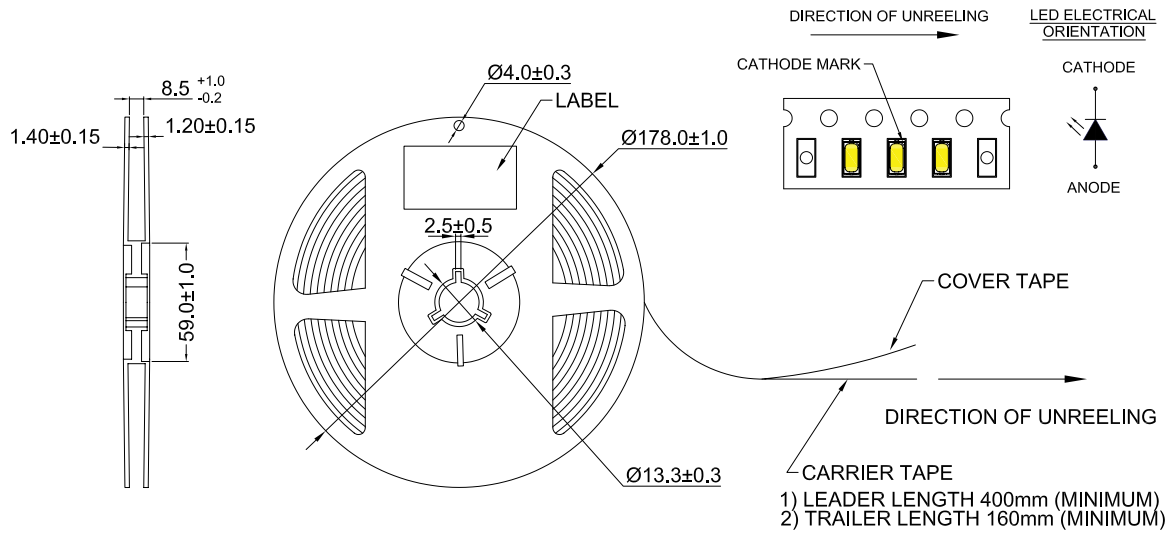

Figure 13. Reel dimensions for LUXEON 3014.

**Notes for Figure 13:**

1. Drawings are not to scale.
2. All dimensions are in millimeters.

## About Lumileds

Companies developing automotive, mobile, IoT and illumination lighting applications need a partner who can collaborate with them to push the boundaries of light. With over 100 years of inventions and industry firsts, Lumileds is a global lighting solutions company that helps customers around the world deliver differentiated solutions to gain and maintain a competitive edge. As the inventor of Xenon technology, a pioneer in halogen lighting and the leader in high performance LEDs, Lumileds builds innovation, quality and reliability into its technology, products and every customer engagement. Together with its customers, Lumileds is making the world better, safer, more beautiful—with light.

To learn more about our lighting solutions, visit [lumileds.com](http://lumileds.com).



©2020 Lumileds Holding B.V. All rights reserved.  
LUXEON is a registered trademark of the Lumileds Holding B.V. in the United States and other countries.

[lumileds.com](http://lumileds.com)

Neither Lumileds Holding B.V. nor its affiliates shall be liable for any kind of loss of data or any other damages, direct, indirect or consequential, resulting from the use of the provided information and data. Although Lumileds Holding B.V. and/or its affiliates have attempted to provide the most accurate information and data, the materials and services information and data are provided "as is," and neither Lumileds Holding B.V. nor its affiliates warrants or guarantees the contents and correctness of the provided information and data. Lumileds Holding B.V. and its affiliates reserve the right to make changes without notice. You as user agree to this disclaimer and user agreement with the download or use of the provided materials, information and data. A listing of Lumileds product/patent coverage may be accessed at [lumileds.com/patents](http://lumileds.com/patents).

DS208 LUXEON 3014  
Product Datasheet 20200426