

Data sheet | Item number: 2002-1301

3-conductor through terminal block; 2.5 mm²; suitable for Ex e II applications; side and center marking; for DIN-rail 35 x 15 and 35 x 7.5; Push-in CAGE CLAMP®; 2,50 mm²; gray

<https://www.wago.com/2002-1301>

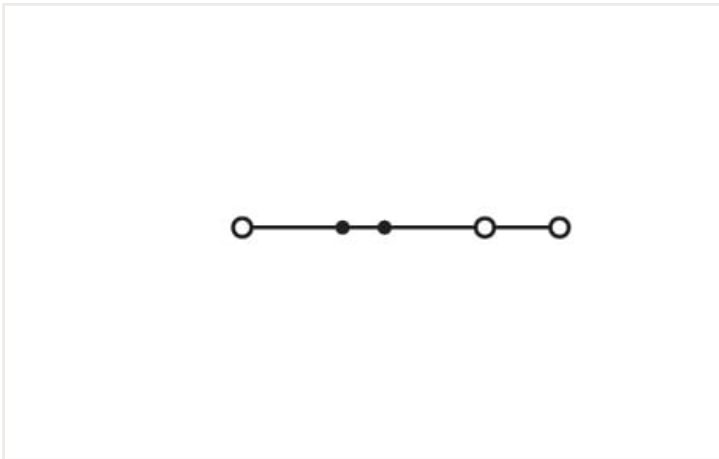
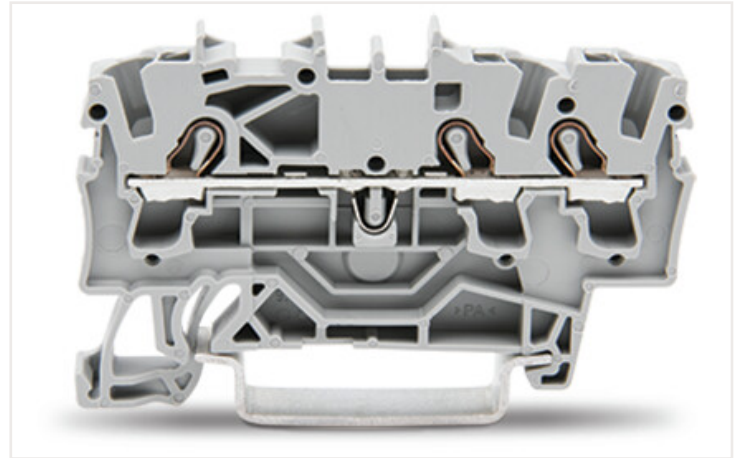
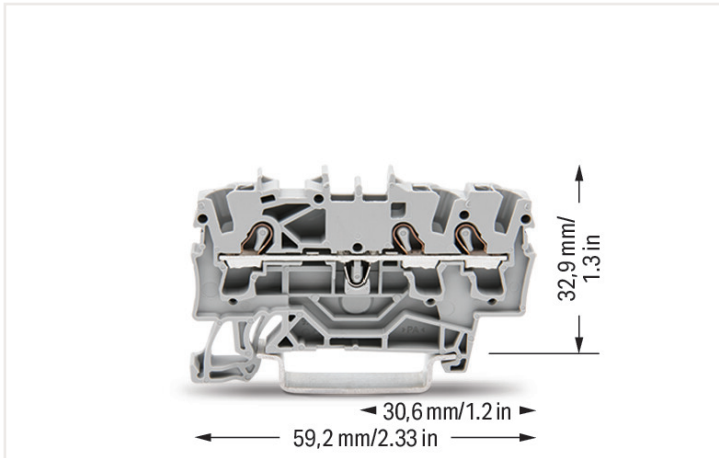

Electrical data

Ratings per IEC/EN

Ratings per	IEC/EN 60947-7-1
Nominal voltage (III/3)	800 V
Rated impulse voltage (III/3)	8 kV
Rated current	24 A
Legend (ratings)	(III / 3) ≙ Overvoltage category III / Pollution degree 3

Ratings per IEC/EN 2

Rated current 2	32 A
-----------------	------

Ratings per UL

Approvals per	UL 1059
Rated voltage UL (Use Group B)	600 V
Rated current UL (Use Group B)	20 A
Rated voltage UL (Use Group C)	600 V
Rated current UL (Use Group C)	20 A

Ratings per CSA

Approvals per	CSA 22.2 No 158
Rated voltage CSA (Use Group B)	600 V
Rated current CSA (Use Group B)	20 A
Rated voltage CSA (Use Group C)	600 V
Rated current CSA (Use Group C)	20 A

Ex information

Reference hazardous areas	See installation notes in section "Knowledge" and Downloads – Documentation – Additional Information: Technical Section; Technical explanations
Ratings per	ATEX: PTB 03 ATEX 1162 U / IECEx: PTB 03.0004U (Ex eb IIC Gb)
Rated voltage EN (Ex e II)	550 V
Rated current (Ex e II)	22 A
Rated current (Ex e II) with jumper	20 A

Power loss

Power loss, per pole (potential)	0.7661 W
Rated current I_N for specified power loss	24 A
Resistance value for specified, current-dependent power loss	0.00133 Ω

Connection data

Connection points	3
Total number of potentials	1
Number of levels	1
Number of jumper slots	2

Connection 1

Connection technology	Push-in CAGE CLAMP®
Actuation type	Operating tool
Connectable conductor materials	Copper
Nominal cross-section	2.5 mm ²
Solid conductor	0.25 ... 4 mm ² / 22 ... 12 AWG
Solid conductor; push-in termination	0.75 ... 4 mm ² / 18 ... 12 AWG
Fine-stranded conductor	0.25 ... 4 mm ² / 22 ... 12 AWG
Fine-stranded conductor; with insulated ferrule	0.25 ... 2.5 mm ² / 22 ... 14 AWG
Fine-stranded conductor; with ferrule; push-in termination	1 ... 2.5 mm ² / 18 ... 14 AWG
Note (conductor cross-section)	Depending on the conductor characteristic, a conductor with a smaller cross-section can also be inserted via push-in termination.
Strip length	10 ... 12 mm / 0.39 ... 0.47 inches
Wiring direction	Front-entry wiring

Physical data

Width	5.2 mm / 0.205 inches
Height	59.2 mm / 2.33 inches
Depth from upper-edge of DIN-rail	32.9 mm / 1.295 inches

Mechanical data

Mounting type	DIN-35 rail
Marking level	Center/side marking

Material data

Note (material data)	Information on material data can be found here
Color	gray
Material group	I
Insulation material	Polyamide (PA66)
Flammability class per UL94	V0
Fire load	0.13 MJ
Weight	6.1 g

Environmental requirements

Processing temperature	-35 ... +85 °C
Continuous operating temperature	-60 ... +105 °C

Commercial data

Product Group	22 (TOPJOB S)
eCl@ss 10.0	27-14-11-20
eCl@ss 9.0	27-14-11-20
ETIM 8.0	EC000897
ETIM 7.0	EC000897
PU (SPU)	100 Stück
Packaging type	Box
Country of origin VKOrg Germany	DE
GTIN	4017332999229
Customs tariff number VKOrg Germany	85369010000

Approvals and certificates

General approvals



Approval	Standard	Certificate name
CCA DEKRA Certification B.V.	EN 60947	71-120369
CCA DEKRA Certification B.V.	EN 60947	NTR NL 7892
CSA DEKRA Certification B.V.	C22.2 No. 158	1536069
UL Underwriters Laboratories Inc.	UL 1059	E45172

Declarations of conformity and manufacturer's declarations

Approval	Standard	Certificate name
Railway WAGO GmbH & Co. KG	-	Railway Ready

Approvals for marine applications



Approval	Standard	Certificate name
ABS American Bureau of Ship- ping	EN 60947	20-HG1941090-PDA
BV Bureau Veritas S.A.	EN 60947	38586/B0 BV
DNV GL Det Norske Veritas, Ger- manischer Lloyd	-	TAE00001V2

Approvals for hazardous areas



Approval	Standard	Certificate name
AEx Underwriters Laboratories Inc.	UL 60079	E185892 (AEx eb IIC resp. Ex eb IIC)
ATEX Physikalisch Technische Bundesanstalt (PTB)	EN 60079	PTB 03 ATEX 1162 U (II2G Ex eb IIC Gb, IM2 Ex eb IMb)
CCC CNEC	GB/T 3836.3	2020312313000238 (Ex eb IIC Gb, Ex eb I Mb)
EAC Brjansker Zertifizierungs- stelle	TP TC 012/2011	RU C-DE.AM02. B.00127/19 (Ex e IIC Gb U)
IECEx Physikalisch Technische Bundesanstalt	IEC 60079	IECEx PTB 03.0004U (Ex eb IIC Gb or Ex eb I Mb)

Downloads

Environmental Product Compliance

Compliance Search

Environmental Product Compliance 2002-1301



Documentation

Additional Information

Technical Section

pdf
2142.18 KB



Bid Text

2002-1301

29.04.2019

xml
4.15 KB



2002-1301

23.04.2019

docx
14.97 KB



CAD/CAE-Data

CAD data

2D/3D Models
2002-1301



CAE data

EPLAN Data Portal
2002-1301



WSCAD Universe
2002-1301



ZUKEN Portal
2002-1301



1 Compatible products

1.1 Required accessories

1.1.1 End plate

1.1.1.1 End plate



[Item no.: 2002-1391](#)

End and intermediate plate; 0.8 mm thick; gray



[Item no.: 2002-1392](#)

End and intermediate plate; 0.8 mm thick; orange



[Item no.: 209-191](#)

Separator for Ex e/Ex i applications; 3 mm thick; 120 mm wide; orange



[Item no.: 2002-1393](#)

Seperator plate; 2 mm thick; oversized; gray



[Item no.: 2002-1394](#)

Seperator plate; 2 mm thick; oversized; orange

1.2 Optional accessories

1.2.1 DIN-rail

1.2.1.1 Mounting accessories



Item no.: 210-196

Aluminum carrier rail; 35 x 8.2 mm; 1.6 mm thick; 2 m long; unslotted; similar to EN 60715; silver-colored



Item no.: 210-198

Copper carrier rail; 35 x 15 mm; 2.3 mm thick; 2 m long; unslotted; according to EN 60715; copper-colored



Item no.: 210-508

Steel carrier rail; 35 x 15 mm; 1.5 mm thick; 2 m long; slotted; galvanized; similar to EN 60715; silver-colored



Item no.: 210-197

Steel carrier rail; 35 x 15 mm; 1.5 mm thick; 2 m long; slotted; similar to EN 60715; silver-colored



Item no.: 210-506

Steel carrier rail; 35 x 15 mm; 1.5 mm thick; 2 m long; unslotted; galvanized; similar to EN 60715; silver-colored



Item no.: 210-114

Steel carrier rail; 35 x 15 mm; 1.5 mm thick; 2 m long; unslotted; similar to EN 60715; silver-colored



Item no.: 210-118

Steel carrier rail; 35 x 15 mm; 2.3 mm thick; 2 m long; unslotted; according to EN 60715; silver-colored



Item no.: 210-115

Steel carrier rail; 35 x 7.5 mm; 1 mm thick; 2 m long; slotted; according to EN 60715; "Hole width 18 mm; silver-colored



Item no.: 210-112

Steel carrier rail; 35 x 7.5 mm; 1 mm thick; 2 m long; slotted; according to EN 60715; "Hole width 25 mm; silver-colored



Item no.: 210-504

Steel carrier rail; 35 x 7.5 mm; 1 mm thick; 2 m long; slotted; galvanized; according to EN 60715; silver-colored



Item no.: 210-113

Steel carrier rail; 35 x 7.5 mm; 1 mm thick; 2 m long; unslotted; according to EN 60715; silver-colored



Item no.: 210-505

Steel carrier rail; 35 x 7.5 mm; 1 mm thick; 2 m long; unslotted; galvanized; according to EN 60715; silver-colored

1.2.2 Ferrule

1.2.2.1 Ferrule



Item no.: 216-241

Ferrule; Sleeve for 0.5 mm² / 20 AWG; insulated; electro-tin plated; electrolytic copper; gastight crimped; acc. to DIN 46228, Part 4/09.90; white



Item no.: 216-242

Ferrule; Sleeve for 0.75 mm² / 18 AWG; insulated; electro-tin plated; electrolytic copper; gastight crimped; acc. to DIN 46228, Part 4/09.90; gray



Item no.: 216-262

Ferrule; Sleeve for 0.75 mm² / 18 AWG; insulated; electro-tin plated; electrolytic copper; gastight crimped; acc. to DIN 46228, Part 4/09.90; gray



Item no.: 216-243

Ferrule; Sleeve for 1 mm² / AWG 18; insulated; electro-tin plated; electrolytic copper; gastight crimped; acc. to DIN 46228, Part 4/09.90; red



Item no.: 216-263

Ferrule; Sleeve for 1 mm² / AWG 18; insulated; electro-tin plated; electrolytic copper; gastight crimped; acc. to DIN 46228, Part 4/09.90; red



Item no.: 216-244

Ferrule; Sleeve for 1.5 mm² / AWG 16; insulated; electro-tin plated; electrolytic copper; gastight crimped; acc. to DIN 46228, Part 4/09.90; black



Item no.: 216-264

Ferrule; Sleeve for 1.5 mm² / AWG 16; insulated; electro-tin plated; electrolytic copper; gastight crimped; acc. to DIN 46228, Part 4/09.90; black



Item no.: 216-246

Ferrule; Sleeve for 2.5 mm² / AWG 14; insulated; electro-tin plated; electrolytic copper; gastight crimped; acc. to DIN 46228, Part 4/09.90; blue



Item no.: 216-266

Ferrule; Sleeve for 2.5 mm² / AWG 14; insulated; electro-tin plated; electrolytic copper; gastight crimped; acc. to DIN 46228, Part 4/09.90; blue

1.2.3 Installation

1.2.3.1 Mounting accessories



Item no.: 709-169

Cover carrier; Type 3; gray



Item no.: 709-156

Cover; Type 3; suitable for cover carrier, type 3; 1 m long; transparent

1.2.4 Insulation stop

1.2.4.1 Insulation stop



Item no.: 2002-171

Insulation stop; 0.25 - 0.5 mm²; 5 pieces/strip; light gray



Item no.: 2002-172

Insulation stop; 0.75 - 1 mm²; 5 pieces/strip; dark gray

1.2.5 Jumper

1.2.5.1 Jumper



Item no.: 2002-400

Continuous jumper; 2-way; insulated; light gray



Item no.: 2002-423/000-006

Continuous jumper; from 1 to 3; insulated; blue



Item no.: 2002-423

Continuous jumper; from 1 to 3; insulated; light gray



Item no.: 2002-423/000-005

Continuous jumper; from 1 to 3; insulated; red



Item no.: 2002-406/020-000

Delta jumper; insulated; light gray



Item no.: 2002-410/000-006

Jumper; 10-way; insulated; blue



Item no.: 2002-410

Jumper; 10-way; insulated; light gray



Item no.: 2002-410/000-005

Jumper; 10-way; insulated; red



Item no.: 2002-402/000-006

Jumper; 2-way; insulated; blue



Item no.: 2002-402

Jumper; 2-way; insulated; light gray



Item no.: 2002-402/000-005

Jumper; 2-way; insulated; red



Item no.: 2002-403/000-006

Jumper; 3-way; insulated; blue



Item no.: 2002-403

Jumper; 3-way; insulated; light gray



Item no.: 2002-403/000-005

Jumper; 3-way; insulated; red



Item no.: 2002-404/000-006

Jumper; 4-way; insulated; blue



Item no.: 2002-404

Jumper; 4-way; insulated; light gray



Item no.: 2002-404/000-005

Jumper; 4-way; insulated; red



Item no.: 2002-405/000-006

Jumper; 5-way; insulated; blue



Item no.: 2002-405

Jumper; 5-way; insulated; light gray



Item no.: 2002-405/000-005

Jumper; 5-way; insulated; red



Item no.: 2002-406/000-006

Jumper; 6-way; insulated; blue



Item no.: 2002-406

Jumper; 6-way; insulated; light gray



Item no.: 2002-406/000-005

Jumper; 6-way; insulated; red



Item no.: 2002-407/000-006

Jumper; 7-way; insulated; blue



Item no.: 2002-407

Jumper; 7-way; insulated; light gray



Item no.: 2002-407/000-005

Jumper; 7-way; insulated; red



Item no.: 2002-408/000-006

Jumper; 8-way; insulated; blue



Item no.: 2002-408

Jumper; 8-way; insulated; light gray



Item no.: 2002-408/000-005

Jumper; 8-way; insulated; red



Item no.: 2002-409/000-006

Jumper; 9-way; insulated; blue



Item no.: 2002-409

Jumper; 9-way; insulated; light gray



Item no.: 2002-409/000-005

Jumper; 9-way; insulated; red



Item no.: 2002-440

Jumper; from 1 to 10; insulated; light gray



Item no.: 2002-433

Jumper; from 1 to 3; insulated; light gray



Item no.: 2002-434

Jumper; from 1 to 4; insulated; light gray



Item no.: 2002-435

Jumper; from 1 to 5; insulated; light gray



Item no.: 2002-436

Jumper; from 1 to 6; insulated; light gray



Item no.: 2002-437

Jumper; from 1 to 7; insulated; light gray



Item no.: 2002-438

Jumper; from 1 to 8; insulated; light gray



Item no.: 2002-439

Jumper; from 1 to 9; insulated; light gray



Item no.: 2002-480

Staggered jumper; 10-way; insulated; light gray



Item no.: 2002-481

Staggered jumper; 11-way; insulated; light gray



Item no.: 2002-482

Staggered jumper; 12-way; insulated; light gray



Item no.: 2002-473/011-000

Staggered jumper; 2-way; from 1 to 3; insulated; light gray



Item no.: 2002-472

Staggered jumper; 2-way; insulated; light gray



Item no.: 2002-473

Staggered jumper; 3-way; insulated; light gray



Item no.: 2002-475/011-000

Staggered jumper; 3-way; insulated; light gray



Item no.: 2002-474



Staggered jumper; 4-way; insulated; light gray

1.2.5.1 Jumper

























 Item no.: 2002-475 Staggered jumper; 5-way; insulated; light gray	 Item no.: 2002-476 Staggered jumper; 6-way; insulated; light gray	 Item no.: 2002-477 Staggered jumper; 7-way; insulated; light gray	 Item no.: 2002-478 Staggered jumper; 8-way; insulated; light gray
 Item no.: 2002-479 Staggered jumper; 9-way; insulated; light gray	 Item no.: 2002-477/011-000 Staggered jumper; insulated; light gray	 Item no.: 2002-479/011-000 Staggered jumper; insulated; light gray	 Item no.: 2002-481/011-000 Staggered jumper; insulated; light gray
 Item no.: 2002-405/011-000 Star point jumper; 3-way; insulated; light gray	 Item no.: 2006-499 Step-down jumper; from 2006/2004 to 2004/2002/2001 series; insulated; light gray	 Item no.: 2016-499 Step-down jumper; from 2016/2010 to 2010/2006/2004/2002 series; insulated; light gray	 Item no.: 210-103 Wire comming chain; insulated; black
 Item no.: 210-123 Wire comming chain; insulated; blue			

1.2.6 Marking

1.2.6.1 Group marker carrier

 Item no.: 2009-191 Group marker carrier; gray	 Item no.: 2009-192 Group marker carrier; gray	 Item no.: 2009-193 Group marker carrier; gray
-----------------------------------------------------------------------------------------------------------------------------------------------	-----------------------------------------------------------------------------------------------------------------------------------------------	------------------------------------------------------------------------------------------------------------------------------------------------

1.2.6.2 Marker

 Item no.: 2009-145/000-006 Mini-WSB Inline; for Smart Printer; 1700 pieces on roll; stretchable 5 - 5.2 mm; plain; snap-on type; blue	 Item no.: 2009-145/000-007 Mini-WSB Inline; for Smart Printer; 1700 pieces on roll; stretchable 5 - 5.2 mm; plain; snap-on type; gray	 Item no.: 2009-145/000-023 Mini-WSB Inline; for Smart Printer; 1700 pieces on roll; stretchable 5 - 5.2 mm; plain; snap-on type; green	 Item no.: 2009-145/000-012 Mini-WSB Inline; for Smart Printer; 1700 pieces on roll; stretchable 5 - 5.2 mm; plain; snap-on type; orange
 Item no.: 2009-145/000-005 Mini-WSB Inline; for Smart Printer; 1700 pieces on roll; stretchable 5 - 5.2 mm; plain; snap-on type; red	 Item no.: 2009-145/000-024 Mini-WSB Inline; for Smart Printer; 1700 pieces on roll; stretchable 5 - 5.2 mm; plain; snap-on type; violet	 Item no.: 2009-145 Mini-WSB Inline; for Smart Printer; 1700 pieces on roll; stretchable 5 - 5.2 mm; plain; snap-on type; white	 Item no.: 2009-145/000-002 Mini-WSB Inline; for Smart Printer; 1700 pieces on roll; stretchable 5 - 5.2 mm; plain; snap-on type; yellow
 Item no.: 248-501/000-006 Mini-WSB marking card; as card; not stretchable; plain; snap-on type; blue	 Item no.: 248-501/000-007 Mini-WSB marking card; as card; not stretchable; plain; snap-on type; gray	 Item no.: 248-501/000-023 Mini-WSB marking card; as card; not stretchable; plain; snap-on type; green	 Item no.: 248-501/000-017 Mini-WSB marking card; as card; not stretchable; plain; snap-on type; light green
 Item no.: 248-501/000-012 Mini-WSB marking card; as card; not stretchable; plain; snap-on type; orange	 Item no.: 248-501/000-005 Mini-WSB marking card; as card; not stretchable; plain; snap-on type; red	 Item no.: 248-501/000-024 Mini-WSB marking card; as card; not stretchable; plain; snap-on type; violet	 Item no.: 248-501 Mini-WSB marking card; as card; not stretchable; plain; snap-on type; white
 Item no.: 248-501/000-002 Mini-WSB marking card; as card; not stretchable; plain; snap-on type; yellow	 Item no.: 793-5501/000-006 WMB marking card; as card; for terminal block width 5 - 17.5 mm; stretchable 5 - 5.2 mm; plain; snap-on type; blue	 Item no.: 793-5501/000-014 WMB marking card; as card; for terminal block width 5 - 17.5 mm; stretchable 5 - 5.2 mm; plain; snap-on type; brown	 Item no.: 793-5501/000-007 WMB marking card; as card; for terminal block width 5 - 17.5 mm; stretchable 5 - 5.2 mm; plain; snap-on type; gray
 Item no.: 793-5501/000-023 WMB marking card; as card; for terminal block width 5 - 17.5 mm; stretchable 5 - 5.2 mm; plain; snap-on type; green	 Item no.: 793-5501/000-017 WMB marking card; as card; for terminal block width 5 - 17.5 mm; stretchable 5 - 5.2 mm; plain; snap-on type; light green	 Item no.: 793-5501/000-012 WMB marking card; as card; for terminal block width 5 - 17.5 mm; stretchable 5 - 5.2 mm; plain; snap-on type; orange	 Item no.: 793-5501/000-005 WMB marking card; as card; for terminal block width 5 - 17.5 mm; stretchable 5 - 5.2 mm; plain; snap-on type; red

1.2.6.2 Marker



Item no.: 793-5501/000-024

WMB marking card; as card; for terminal block width 5 - 17.5 mm; stretchable 5 - 5.2 mm; plain; snap-on type; violet

Item no.: 793-5501

WMB marking card; as card; for terminal block width 5 - 17.5 mm; stretchable 5 - 5.2 mm; plain; snap-on type; white

Item no.: 793-5501/000-002

WMB marking card; as card; for terminal block width 5 - 17.5 mm; stretchable 5 - 5.2 mm; plain; snap-on type; yellow

Item no.: 793-501/000-006

WMB marking card; as card; not stretchable; plain; snap-on type; blue



Item no.: 793-501/000-007

WMB marking card; as card; not stretchable; plain; snap-on type; gray

Item no.: 793-501/000-023

WMB marking card; as card; not stretchable; plain; snap-on type; green

Item no.: 793-501/000-017

WMB marking card; as card; not stretchable; plain; snap-on type; light green

Item no.: 793-501/000-012

WMB marking card; as card; not stretchable; plain; snap-on type; orange



Item no.: 793-501/000-005

WMB marking card; as card; not stretchable; plain; snap-on type; red

Item no.: 793-501/000-024

WMB marking card; as card; not stretchable; plain; snap-on type; violet

Item no.: 793-501

WMB marking card; as card; not stretchable; plain; snap-on type; white

Item no.: 793-501/000-002

WMB marking card; as card; not stretchable; plain; snap-on type; yellow



Item no.: 2009-115/000-006

WMB-Inline; for Smart Printer; 1500 pieces on roll; stretchable 5 - 5.2 mm; plain; snap-on type; blue

Item no.: 2009-115/000-007

WMB-Inline; for Smart Printer; 1500 pieces on roll; stretchable 5 - 5.2 mm; plain; snap-on type; gray

Item no.: 2009-115/000-023

WMB-Inline; for Smart Printer; 1500 pieces on roll; stretchable 5 - 5.2 mm; plain; snap-on type; green

Item no.: 2009-115/000-017

WMB-Inline; for Smart Printer; 1500 pieces on roll; stretchable 5 - 5.2 mm; plain; snap-on type; light green



Item no.: 2009-115/000-012

WMB-Inline; for Smart Printer; 1500 pieces on roll; stretchable 5 - 5.2 mm; plain; snap-on type; orange

Item no.: 2009-115/000-005

WMB-Inline; for Smart Printer; 1500 pieces on roll; stretchable 5 - 5.2 mm; plain; snap-on type; red

Item no.: 2009-115/000-024

WMB-Inline; for Smart Printer; 1500 pieces on roll; stretchable 5 - 5.2 mm; plain; snap-on type; violet

Item no.: 2009-115

WMB-Inline; for Smart Printer; 1500 pieces on roll; stretchable 5 - 5.2 mm; plain; snap-on type; white



Item no.: 2009-115/000-002

WMB-Inline; for Smart Printer; 1500 pieces on roll; stretchable 5 - 5.2 mm; plain; snap-on type; yellow

1.2.6.3 Marker carrier



Item no.: 2002-161

Adaptor; gray

Item no.: 2009-198

Adaptor; gray

1.2.6.4 Marking strip



Item no.: 2009-110

Marking strips; for Smart Printer; on reel; not stretchable; plain; snap-on type; white

1.2.7 Plug

1.2.7.1 Diode plug



Item no.: 2002-880/1000-411

Component plug; 2-pole; with diode 1N4007; 10.4 mm wide; Operating temperature 85°C max.; gray

1.2.7.2 Empty component plug housing



Item no.: [2002-880](#)

Empty component plug housing; 10.4 mm wide; 2-pole; Type 4; gray

1.2.7.3 LED plug



Item no.: [2002-880/1000-541](#)

Component plug; 2-pole; LED (red); 10.4 mm wide; Operating temperature 85°C max.; gray



Item no.: [2002-880/1000-836](#)

Component plug; 2-pole; LED (red); 10.4 mm wide; Operating temperature 85°C max.; gray



Item no.: [2002-880/1000-542](#)

Component plug; 2-pole; LED (red); 10.4 mm wide; Operating temperature 85°C max.; multicoloured

1.2.8 Protective warning marker

1.2.8.1 Cover



Item no.: [2002-115](#)

Protective warning marker; for 5 terminal blocks; with high-voltage symbol, black; yellow

1.2.9 Push-in type wire jumper

1.2.9.1 Jumper



Item no.: [2009-414](#)

Push-in type wire jumper; 1.5 mm²; insulated; 110 mm long; black



Item no.: [2009-414/000-005](#)

Push-in type wire jumper; 1.5 mm²; insulated; 110 mm long; black



Item no.: [2009-416](#)

Push-in type wire jumper; 1.5 mm²; insulated; 250 mm long; black



Item no.: [2009-414/000-006](#)

Push-in type wire jumper; insulated; 110 mm long; black



Item no.: [2009-412](#)

Push-in type wire jumper; insulated; 60 mm long; black

1.2.10 Test and measurement

1.2.10.1 Testing accessories



Item no.: [2002-560](#)

Modular TOPJOB®S connector; modular; for jumper contact slot; 10-pole; 2,50 mm²; gray



Item no.: [2002-511](#)

Modular TOPJOB®S connector; modular; for jumper contact slot; 1-pole; 2,50 mm²; gray



Item no.: [2002-552](#)

Modular TOPJOB®S connector; modular; for jumper contact slot; 2-pole; 2,50 mm²; gray



Item no.: [2002-553](#)

Modular TOPJOB®S connector; modular; for jumper contact slot; 3-pole; 2,50 mm²; gray



Item no.: [2002-554](#)

Modular TOPJOB®S connector; modular; for jumper contact slot; 4-pole; 2,50 mm²; gray



Item no.: [2002-555](#)

Modular TOPJOB®S connector; modular; for jumper contact slot; 5-pole; 2,50 mm²; gray



Item no.: [2002-556](#)

Modular TOPJOB®S connector; modular; for jumper contact slot; 6-pole; 2,50 mm²; gray



Item no.: [2002-557](#)

Modular TOPJOB®S connector; modular; for jumper contact slot; 7-pole; 2,50 mm²; gray



Item no.: [2002-558](#)

Modular TOPJOB®S connector; modular; for jumper contact slot; 8-pole; 2,50 mm²; gray



Item no.: [2002-559](#)

Modular TOPJOB®S connector; modular; for jumper contact slot; 9-pole; 2,50 mm²; gray



Item no.: [2002-549](#)

Spacer module; modular; e.g., for bridging commoned terminal blocks; gray



Item no.: [2009-174](#)

Test plug adapter; for 4 mm Ø test plugs; for testing TOPJOB®S rail-mounted terminal blocks; gray

1.2.10.1 Testing accessories



Item no.: 2009-182

Testing tap; for max. 2.5 mm²; tool-free connection for individual test wires 0.08 - 2.5 mm; gray



Item no.: 2002-649

TOPJOB®S L-type spacer module; modular; e.g., for bridging commoned terminal blocks; gray



Item no.: 2002-611

TOPJOB®S L-type test plug module; modular; 1-pole; 2,50 mm²; gray

1.2.11 Tool

1.2.11.1 Operating tool



Item no.: 210-658

Operating tool; Blade: 3.5 x 0.5 mm; with a partially insulated shaft; angled; short; multicoloured



Item no.: 210-720

Operating tool; Blade: 3.5 x 0.5 mm; with a partially insulated shaft; multicoloured

Installation notes

Conductor termination

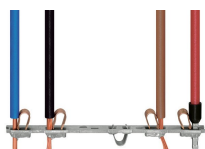

All conductor types at a glance

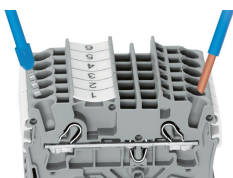

Push-in termination of solid and ferruled conductors

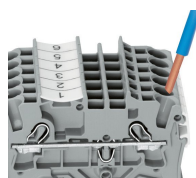

Inserting a conductor via push-in termination:
Solid conductors with cross-sections from either one size above, or up to two sizes below, the rated cross-section can be simply pushed in – no tools needed.

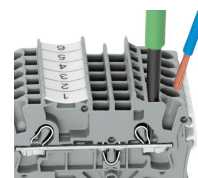

Inserting a conductor via operating tool:
Connecting fine-stranded conductors without ferrules, or small cross-sectional conductors that cannot be pushed in, is performed similarly to the original CAGE CLAMP® – just use an operating tool.
Advantage:
To open the clamp, the operating tool is inserted vertically. The conductor entry is less than 15 degrees for easier wiring.

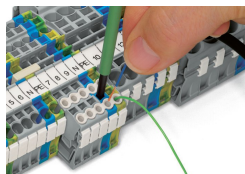

Conductor termination – insulation stop

Commoning

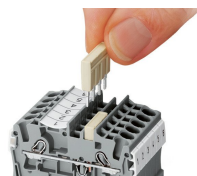

Insert push-in type jumper bar and push down until it hits backstop.

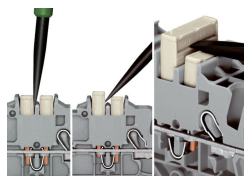

Removing a push-in type jumper bar:
Insert the operating tool between the jumper and partition wall of the dual jumper slots, then lift up the jumper.
Place the operating tool in the center of jumpers for up to five contacts (see above), or alternately on both sides for jumpers with more than five contacts.

Commoning

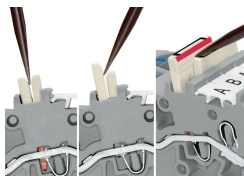
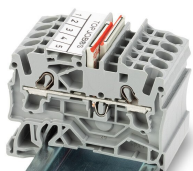

Orient the staggered jumpers' red stripes on the inside. Insert the staggered jumper and push down until it hits the backstop.

Removing a staggered jumper: Insert the operating tool between the staggered jumpers, then lift up the jumper.

Commoning

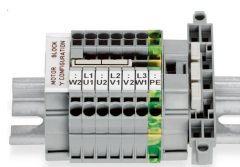

Continuous jumpers (2002 Series) readily connect an endless number of terminal blocks to each other via single jumper slot. Use the second jumper slot for additional commoning or testing.

The 1-to-3 adjacent jumper for continuous commoning enables every other terminal block to be commoned. For example, positive and negative potentials can be accommodated alongside each other.

This star point jumper has been specially developed to create a "star point" and is used on motor terminal boards equipped with Rail-Mount Terminal Blocks TOPJOB® S.

This delta jumper has been specially developed to create a delta configuration and is used on motor terminal boards equipped with rail-mount terminal blocks TOPJOB® S.

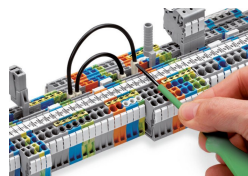

Push down the wire jumper until fully inserted. Lift the jumper with an operating tool for rewiring.

Commoning

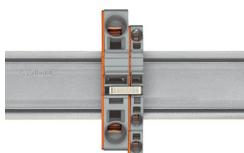
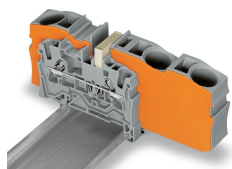

Step-down jumpers common terminal blocks of different sizes, without losing a conductor clamping point. This can be beneficial on long conductor runs where voltage drop can be a problem. A large conductor can be easily connected to smaller conductors at the distribution point. Commoning may be made in either direction using the special thin end plate to cover the open side. Additional through terminal blocks having a smaller cross-section may be commoned using push-in type jumper bars.

Using step-down jumpers, an end plate must be inserted between the terminal blocks to be commoned.

Step-down jumper (2006-499) commons 6/4 mm² (10/12 AWG) terminal blocks (2006/2004 Series) with 4/2.5/1.5 mm² (AWG 12/14/16) terminal blocks (2004/2002/2001 Series).

Step-down jumper (2016-499) commons 16/10 mm² (16/8 AWG) terminal blocks (2016/2010 Series) with 10/6/4/2.5 mm² (8/10/12/14 AWG) terminal blocks (2010/2006/2004/2002 Series).

Commoning

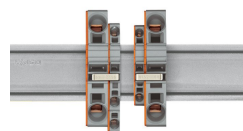
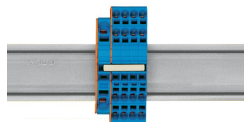
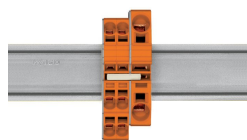

Stepping down via push-in type jumper bar:
Commoning via open terminal side with end plate allows jumpering over two cross-section sizes for 16 mm² (6 AWG) and 10 mm² (8 AWG) and one cross-section size for 6/4/2.5 mm² (10/12/14 AWG). An example: from 16 mm² (6 AWG) to 6 mm² (10 AWG) (see illustration above) or from 10 mm² (8 AWG) to 4 mm² (12 AWG).

Stepping down via push-in type jumper bar:
Commoning via closed terminal side with end plate allows jumpering over two cross-section sizes, e.g., from 16 mm² (6 AWG) to 6 mm² (10 AWG) or from 6 mm² (10 AWG) to 2.5 mm² (14 AWG) (see illustration above).

Note:
The total current of the outgoing circuits must not exceed the nominal current of the step-down jumper/push-in type jumper bar.

Testing

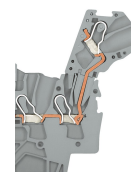
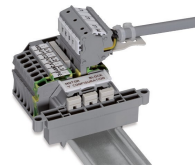
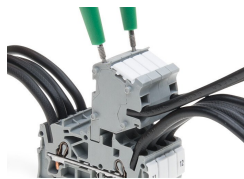
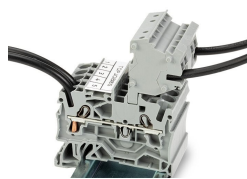

The modular TOPJOB® S connectors also connect conductors of the same size as the terminal blocks being used.

TOPJOB® S Connectors with a 2 mm Ø test socket for testing voltage via 2-pole voltage tester

Rail-mount terminal block assembly for electric motor wiring

L-type test plug module – cross-sectional view of contacts



Test plug adapter (2009-174, CAT I) for 4 mm Ø plugs – compatible with 2000 to 2016 Series

Testing tap (2009-182) for tool-free connection of test cables up to 2.5 mm² (12 AWG) – compatible with 2000 to 2016 Series

Marking

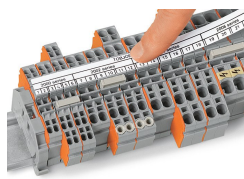
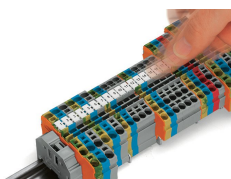

Snapping WMB Inline markers into marker slots.

TOPJOB® S 2009-193 Group Marker Carrier (equipped with a marking strip) for all 2001 to 2016 Series TOPJOB® S Rail-Mount Terminal Blocks
Do not use on an end plate!

Using marker carriers for marking strips (2002-161) in jumper slots.

Ex application

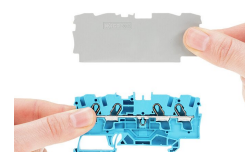
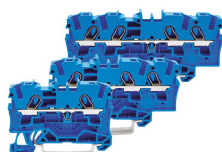
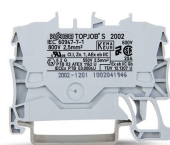

Through terminal blocks with a blue insulated housing are suitable for Ex i applications.

All through and ground conductor terminal blocks are suitable for Ex e II applications.

Separator plate for Ex e/Ex i applications
An end plate must be applied to the terminal block located directly behind an Ex e/Ex i separator plate.

Ex application

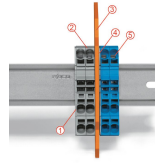

Ex e II/Ex i terminal strip

Note:

The movable feet of terminal blocks and separator plates must face the same direction.

A separator plate is located between the Ex e II and Ex i terminal strip.

End plate

Ex e II terminal blocks

Separator plate for Ex e/Ex i applications

End plate

Ex i terminal blocks

According to EN 50020, a minimum distance of 50 mm must be kept between live parts of Ex e and Ex i circuits. The use of Ex e/Ex i separators is a space-saving solution when Ex e and Ex i terminal blocks are mounted on a common DIN-rail.