



[www.niccomp.com/pcn](http://www.niccomp.com/pcn) | Technical Support: [tpmg@niccomp.com](mailto:tpmg@niccomp.com)

Issued: March 29th, 2019  
SUB: EOL Notice

Product Type: Surface Mount UV LEDs  
NIC Series: NUVA and NUVC Series

Notification: End of Life Notification

The following is notification of the end of life for the NUVA and NUVC series of surface mount UV LEDs effective March 29<sup>th</sup>, 2019. A list of the affected parts numbers can be found in table #1.

Last Order Date: September 29<sup>th</sup>, 2019 for established customers with existing business on these part numbers  
Last Ship Date: March 29<sup>th</sup>, 2020 for established customers with existing business on these part numbers

Reason for Discontinuation: Low Demand  
Prepared by: Technical Product Marketing Group / [tpmg@niccomp.com](mailto:tpmg@niccomp.com)

Series	Discontinued Part Numbers	Size	Wavelength
NUVA33	NUVA33R365TRF	3.4x3.4x2.37mm	365nm
NUVA33	NUVA33R365TRSF	3.4x3.4x2.37mm	365nm
NUVA33	NUVA33HP1R7R365TRF	3.4x3.4x2.37mm	365nm
NUVA33	NUVA33T385TRF	3.4x3.4x2.37mm	385nm
NUVA33	NUVA33U395TRF	3.4x3.4x2.37mm	395nm
NUVA33	NUVA33V405TRF	3.4x3.4x2.37mm	405nm
NUVA35	NUVA35R365TRF	3.4x3.4x3.34mm	365nm
NUVA35	NUVA35T385TRF	3.4x3.4x3.34mm	385nm
NUVA35	NUVA35U395TRF	3.4x3.4x3.34mm	395nm
NUVA35	NUVA35V405TRF	3.4x3.4x3.34mm	405nm
NUVA66	NUVA66R365TRF	6.0x6.0x1.20mm	365nm
NUVA66	NUVA66R365STAR1F	6.0x6.0x1.20mm	365nm
NUVA66	NUVA66HP2R365TRF	6.0x6.0x1.20mm	365nm
NUVA66	NUVA66T385TRF	6.0x6.0x1.20mm	385nm
NUVA66	NUVA66HP2T385TRF	6.0x6.0x1.20mm	385nm
NUVA66	NUVA66U395TRF	6.0x6.0x1.20mm	395nm
NUVA66	NUVA66HP2U395TRF	6.0x6.0x1.20mm	395nm
NUVA66	NUVA66V405TRF	6.0x6.0x1.20mm	405nm
NUVA66	NUVA66HP2V405TRF	6.0x6.0x1.20mm	405nm
NUVA77	NUVA77R365TRF	6.8x6.8x1.45mm	365nm
NUVA77	NUVA77T385TRF	6.8x6.8x1.45mm	385nm
NUVA77	NUVA77U395TRF	6.8x6.8x1.45mm	395nm
NUVA77	NUVA77HP6U395TRF	6.8x6.8x1.45mm	395nm
NUVA77	NUVA77V405TRF	6.8x6.8x1.45mm	405nm
NUVC66	NUVC66DW278TRF	6.0x6.0x1.35mm	278nm

→ Follow NIC PCN alerts to get email notifications of EOL and PCN announcements at [www.niccomp.com/pcn](http://www.niccomp.com/pcn)

## FEATURES

- SURFACE MOUNT 3.4mm x 3.4mm x 3.34mm
- WAVELENGTH 365 ~ 405nm FOR UV CURING, PHOTO CATALYST & SENSOR LIGHTING
- RoHS COMPLIANT
- COMPATIBLE WITH REFLOW SOLDERING
- TAPE AND REEL PACKAGING

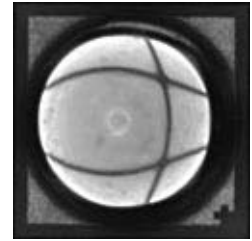

SPECIFICATIONS	Case Sizes
Wavelength	365nm ~ 405nm (nominal)
Forward Current	500mA
Radiant Flux	870mW ~ 1000mW (typical)
Power Dissipation	3.01W (385nm ~ 405nm), 3.08W (365nm)
Operating Temperature*	-10°C ~ +85°C
Junction Temperature (Tj)	+90°C ~ +125°C max.
Thermal Resistance (Typical) <sup>Note 1</sup>	4.5°C/W
Viewing Angle (2 θ 1/2)	45° ~ 55°

Note 1 - Rthj-c = Thermal Resistance (Junction - Case)

\*After soldering storage temperature is -40°C ~ +100°C

## PART NUMBERING SYSTEM

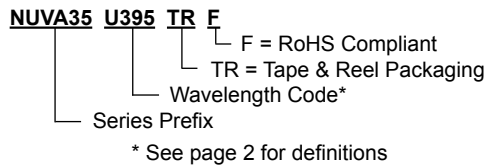

## WAVELENGTH CODES

Code	Nominal Wavelength
R	365nm
T	385nm
U	395nm
V	405nm

## COMPONENT DIMENSIONS

Item	Dimension (mm)
L	3.40
R	φ3.10
H1	3.34
H2	0.79
H3	0.69
W	3.40
T1	1.30
T2	2.30
T3	3.20
Wt	3.20

Tolerance: ±0.13

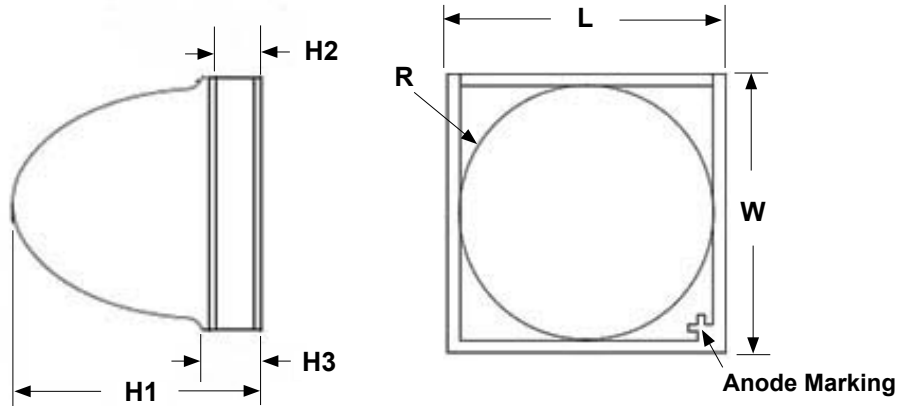

Termination	Connection
1	Anode
2	Thermal Pad
3	Cathode

## Internal Circuit Diagram

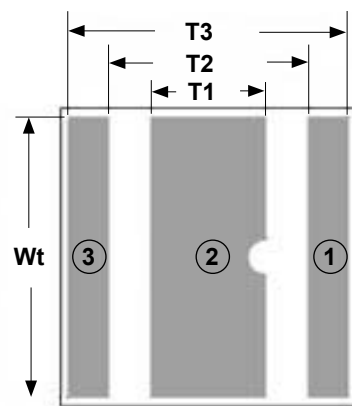
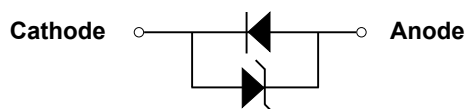

## RANKING CODES (Forward Current - 500mA)

Part Numbers	Ranking Codes (Note 2)	Wavelength (nm)	Radiant Flux (mW)		Voltage (V)		Thermal Resistance (Typical) <sup>Note 1</sup> Rth j-c	Junction Temperature °C	Spectrum Half Width (Typical) Δλ	Viewing Angle (Typical) 2 θ 1/2
			Min.	Max.	Min.	Max.				
NUVA35R365TRF	P11-V2	360 ~ 370	810	870	3.2	3.6	4.5°C/W	<90°C	9.0nm	55°
	P11-V3				3.6	3.8				
	P12-V2		870	960	3.2	3.6				
	P12-V3				3.6	3.8				
NUVA35T385TRF	HP11-V2	380 ~ 390	910	1000	3.3	3.5				
	HP11-V3				3.5	3.7				
	HP12-V2		1000	1100	3.3	3.5				
	HP12-V3				3.5	3.7				
NUVA35U395TRF	HP11-V2	390 ~ 400	910	1000	3.3	3.5				
	HP11-V3				3.5	3.7				
	HP12-V2		1000	1100	3.3	3.5				
	HP12-V3				3.5	3.7				
NUVA35V405TRF	HP11-V2	400 ~ 410	910	1000	3.3	3.5				
	HP11-V3				3.5	3.7				
	HP12-V2		1000	1100	3.3	3.5				
	HP12-V3				3.5	3.7				

Note 1 - Rthj-c = Thermal Resistance (Junction - Case)

Note 2 - Actual ranking code will be specified by NIC on reel label.

### FORWARD VOLTAGE VS. FORWARD CURRENT @ +25°C

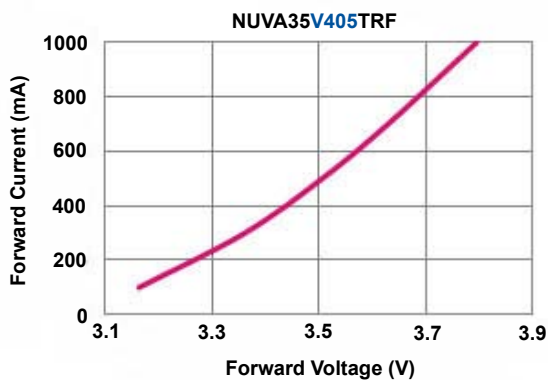
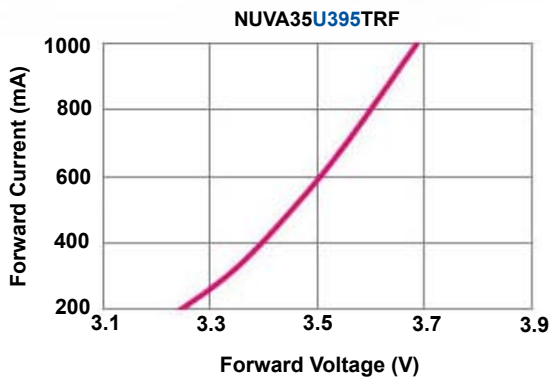
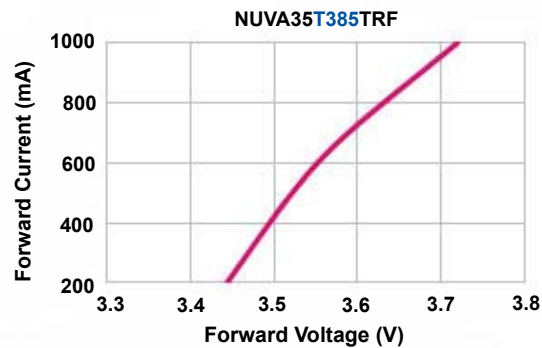
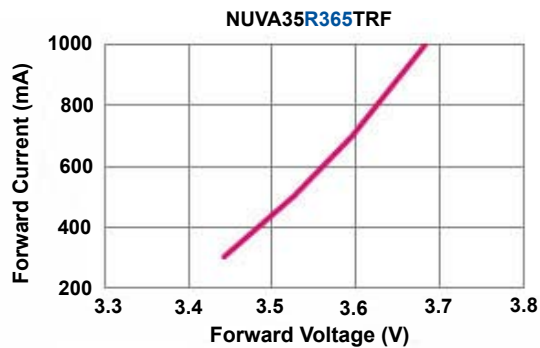

## FORWARD CURRENT VS. RELATIVE RADIANT FLUX @ +25°C

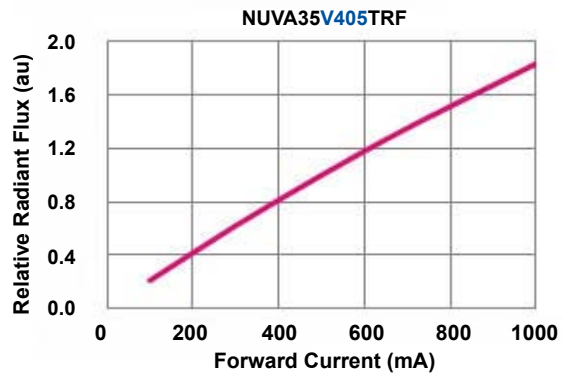
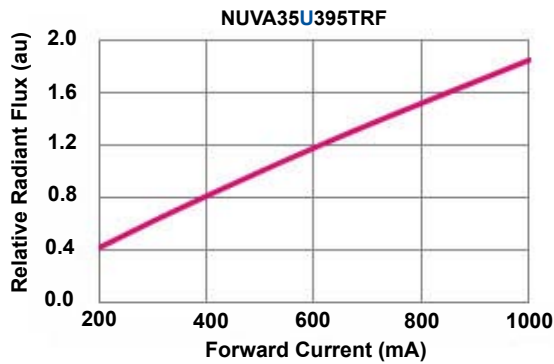
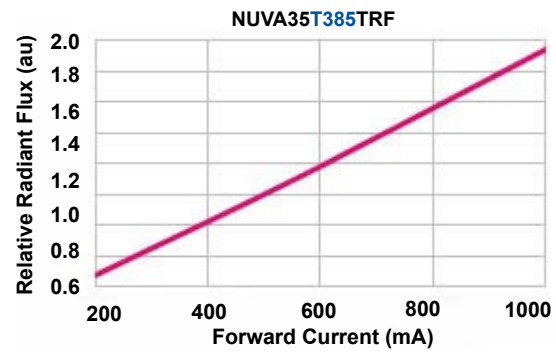
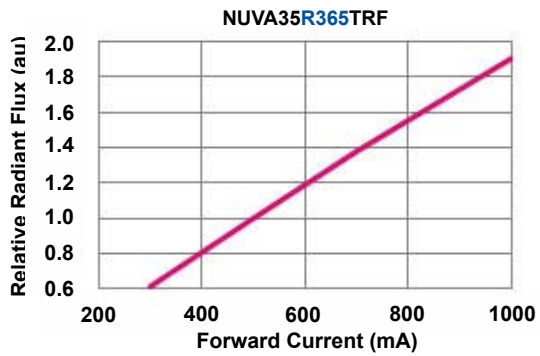

## SPECTRUM @ +25°C & 500mA

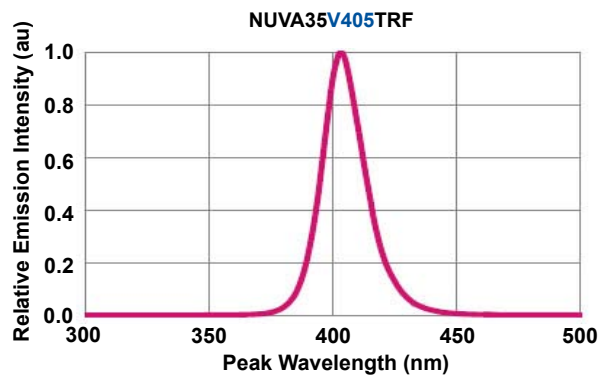
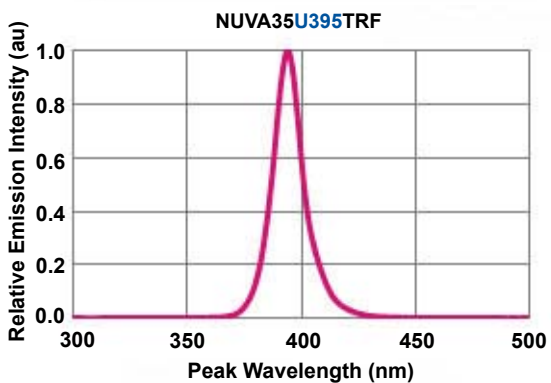
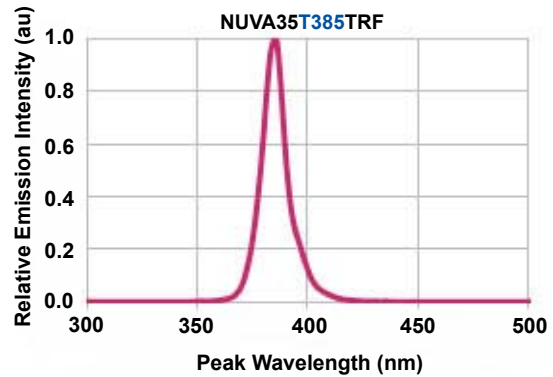
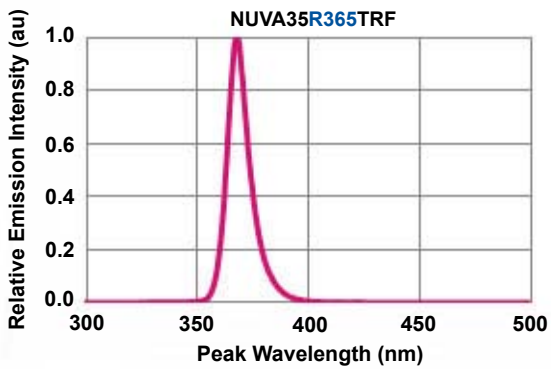

©

### FORWARD CURRENT VS. PEAK WAVELENGTH @ +25°C

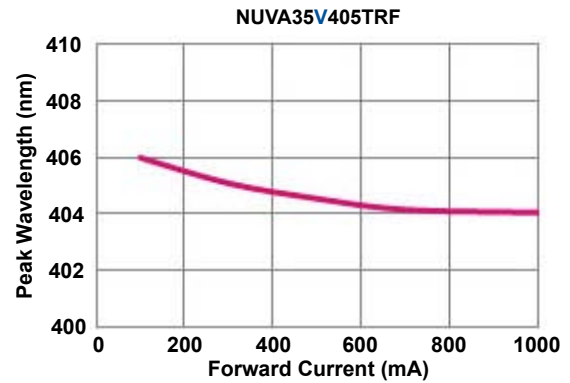
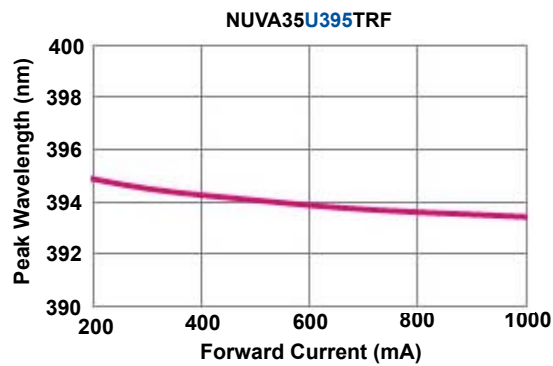
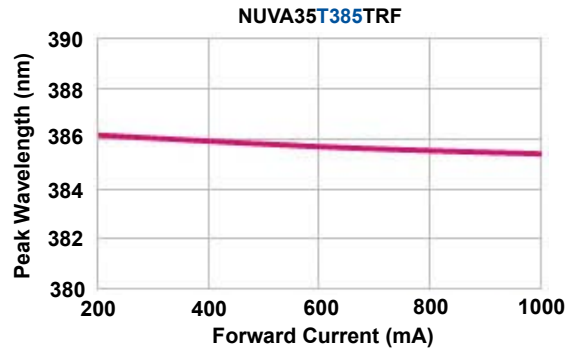
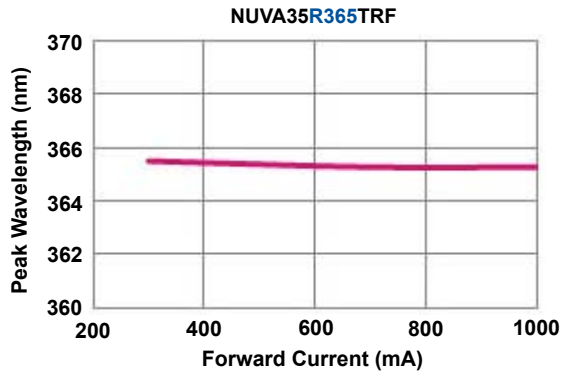

### RADIATION CHARACTERISTICS (Angle of Beam Spread, Directivity) +25°C, 500mA If

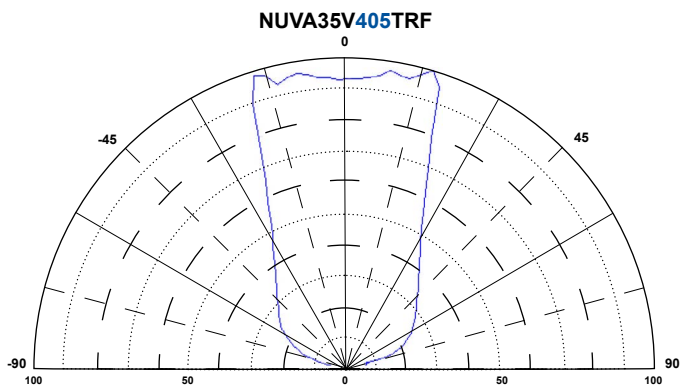
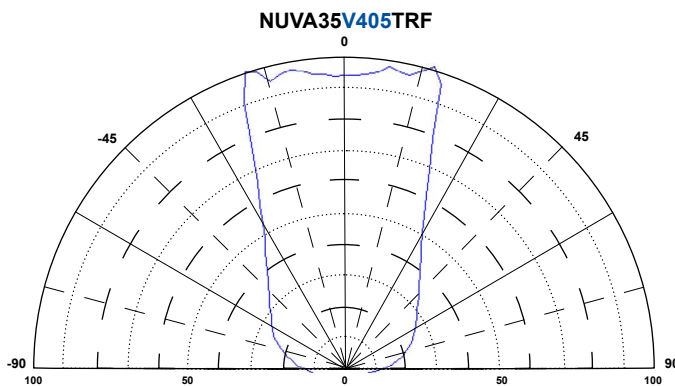
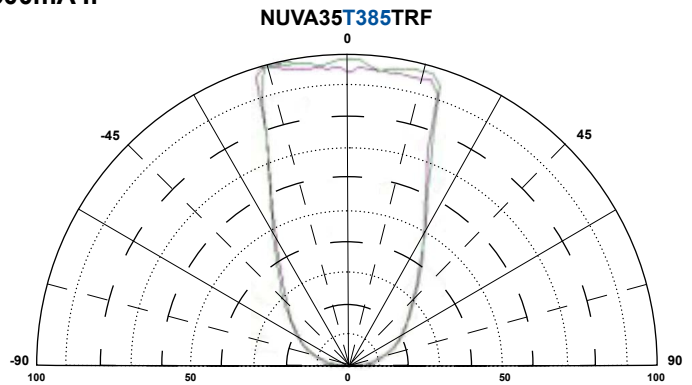
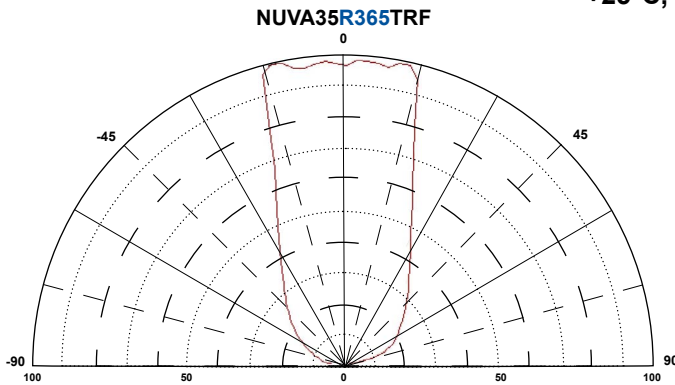

®

## AMBIENT TEMPERATURE VS. PEAK WAVELENGTH @ 500mA If

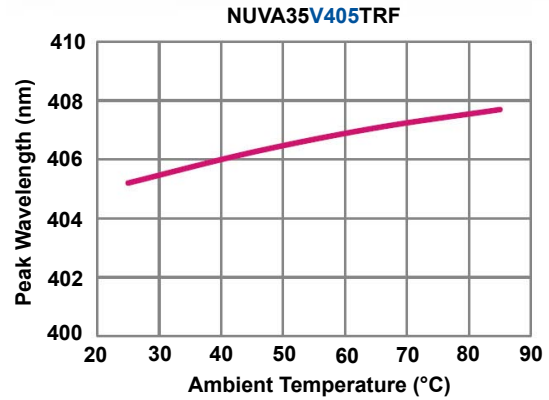
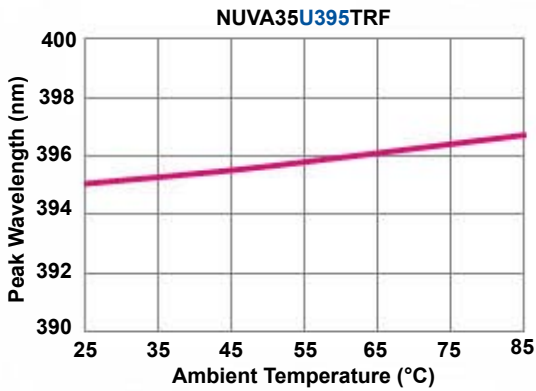
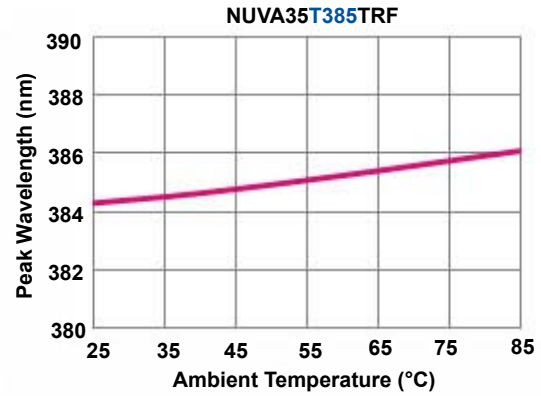
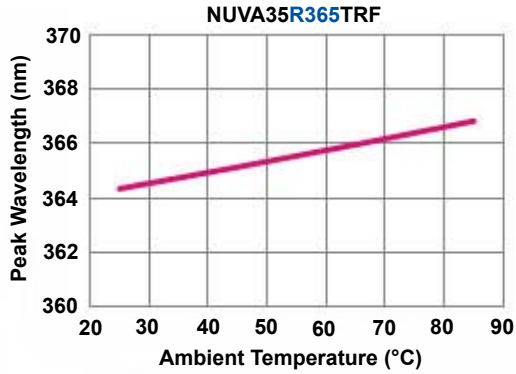

## AMBIENT TEMPERATURE VS. RELATIVE RADIANT FLUX @ 500mA If

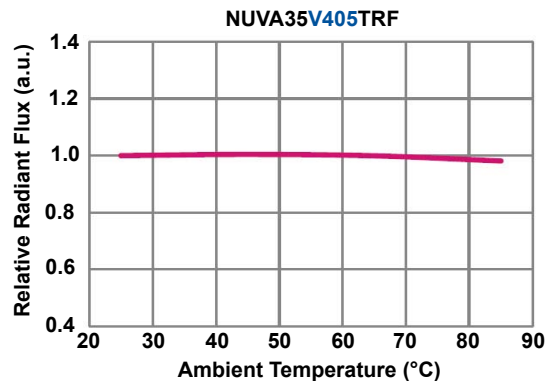
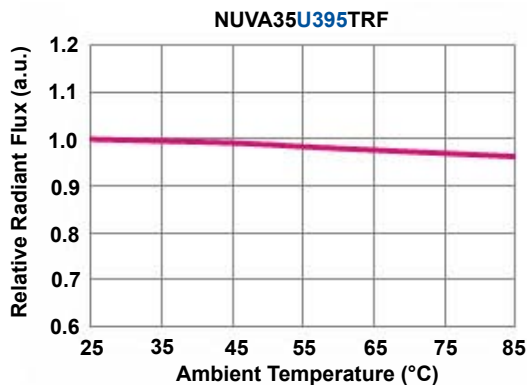
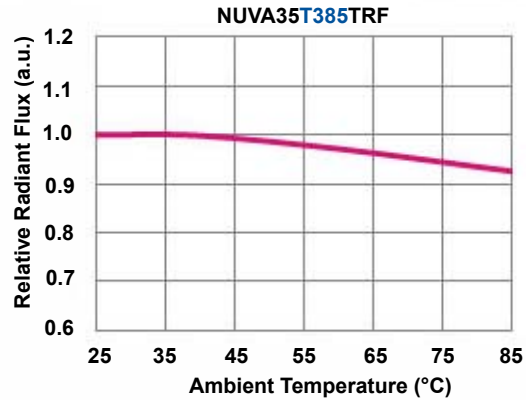
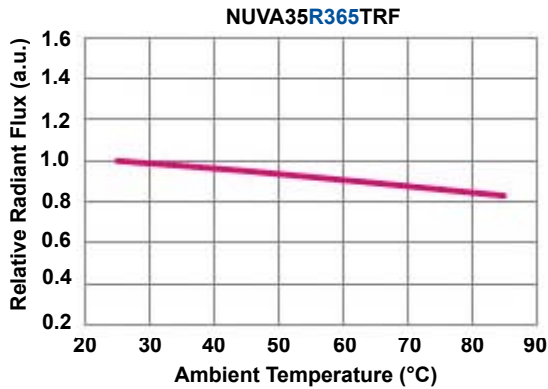

®

AMBIENT TEMPERATURE VS. FORWARD VOLTAGE @ 500mA If

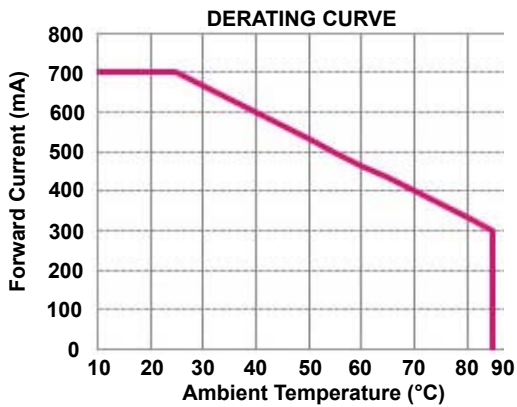
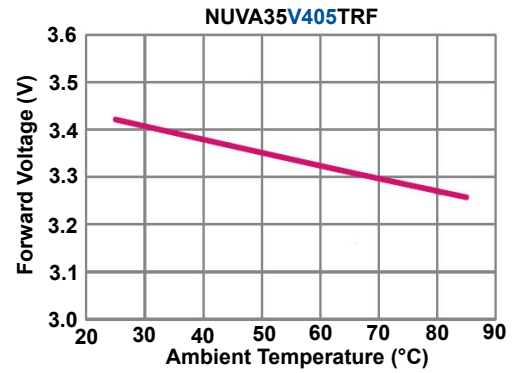
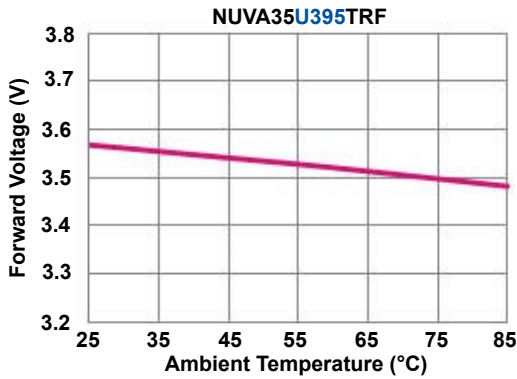
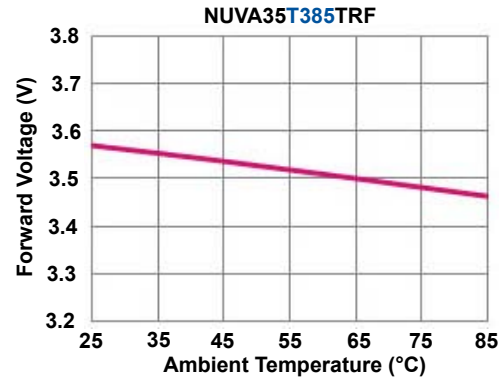
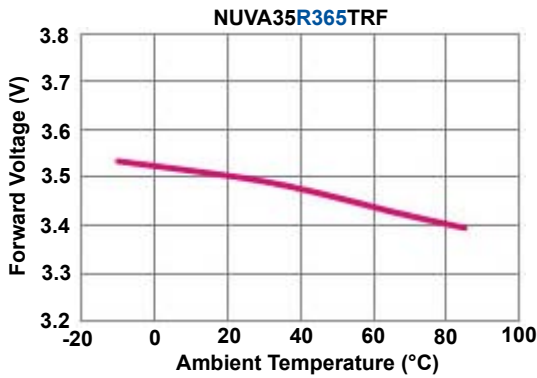

**NUVA35R365TRF:** Tj = 090°C, Rth j-a ~ 10°C/W  
**NUVA35T385TRF:** Tj = 125°C, Rth j-a ~ 10°C/W  
**NUVA35U395TRF:** Tj = 125°C, Rth j-a ~ 10°C/W  
**NUVA35V405TRF:** Tj = 125°C, Rth j-a ~ 10°C/W

Item	Conditions	Failure Criteria
Load Life 1	+25°C, 500mA for 1,000 hours	Forward Voltage (Vf): ±10 of initial value Radiant Flux (φe): ±30 of initial value
Load Life 2	+25°C, 700mA for 1,000 hours	
High Temperature Load Life	For 365nm +85°C, 100mA for 1,000 hours For 385nm ~ 405nm +85°C, 300mA for 1,000 hours	
Humidity Load Life	For 365nm, +60°C, 90% RH, 350mA for 500 hours For 385nm ~ 405nm, +60°C, 90% RH, 450mA for 500 hours	
Load Temperature Load Life	-10°C, 500mA for 1,000 hours	
High Temperature Storage	+100°C for 1,000 hours	
Low Temperature Storage	-40°C for 1,000 hours	
Temperature Cycling 100 Cycles	-40°C (30 minutes) ~ +25°C (5 minutes) +100°C (30 minutes) ~ +25°C (5 minutes)	
Resistance to Vibration	100Hz ~ 1,000Hz ~ 100Hz for 4 minutes, 200m/s², 3 directions for 48 minutes total	
ESD (Human Body Model)	R = 1.5KΩ, C = 100pF Test Voltage = 2KV 3 times negative/positive	
Moisture Sensitivity (MSL)	3 time reflow with peak temperature +260°C Pre-conditioning: +60°C, 60% RH for 168 hours	

®



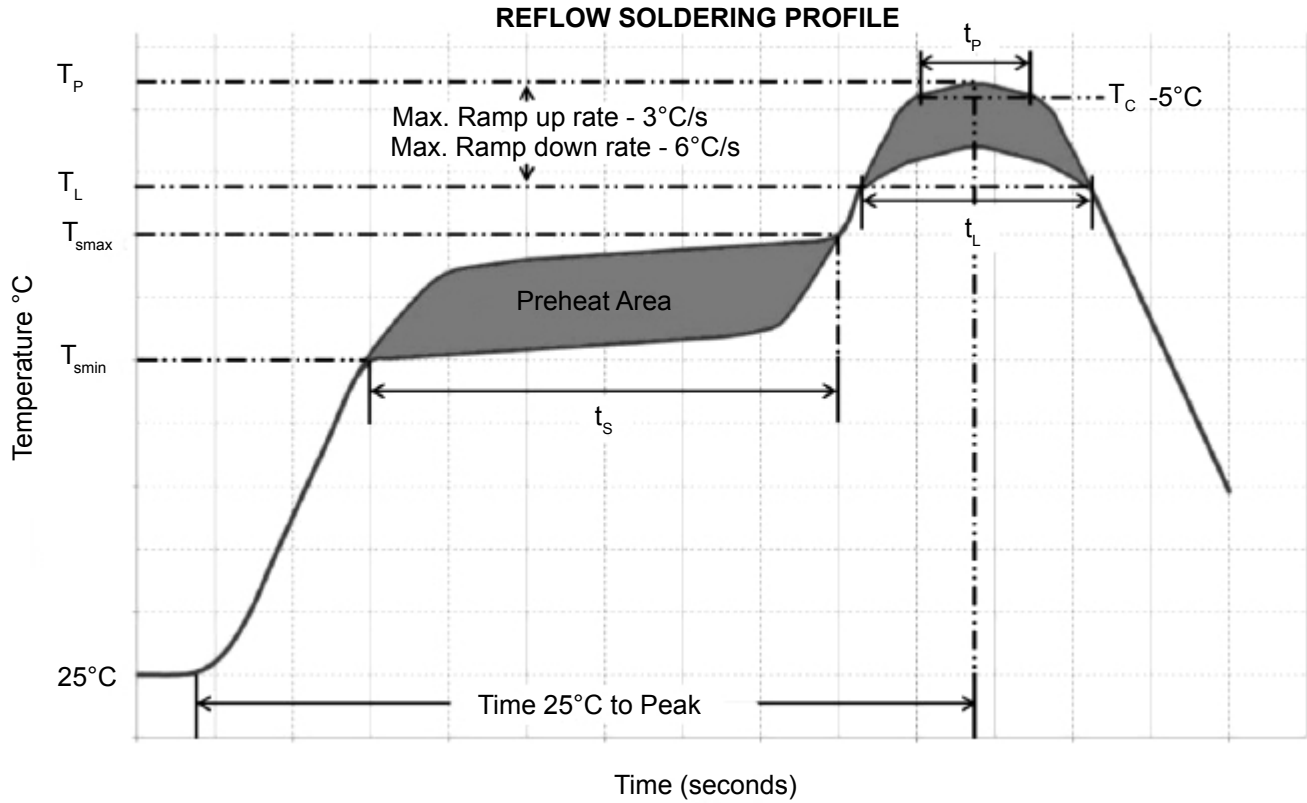

**LAND PATTERN DIMENSIONS**

Item	Dimension (mm)
a	$3.3 \pm 0.13$
b	$1.3 \pm 0.13$
c	$2.3 \pm 0.13$
d	$3.3 \pm 0.13$
e	$0.5 \pm 0.13$
f	$0.5 \pm 0.13$
g	$0.5 \pm 0.13$

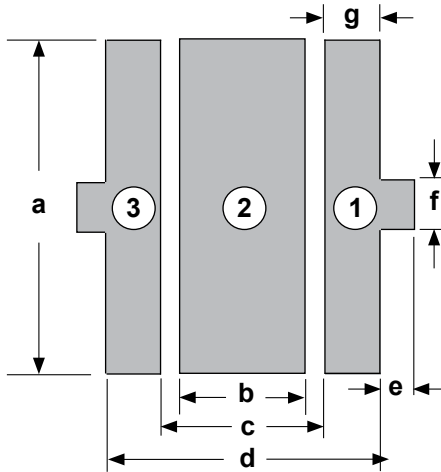

Land Pad	Connection
1	Anode
2	Thermal Pad
3	Cathode



### EMBOSSED PLASTIC TAPE DIMENSIONS (mm)

Type	Size	A ± 0.10	B ± 0.10	D +0.1/-0	E ± 0.10	F ± 0.1	P <sub>0</sub> ± 0.1	P <sub>1</sub> ± 0.1	P <sub>2</sub> ± 0.1	W ± 0.3	T ± 0.1
NUVA35	3.4 x 3.4	3.65	3.65	1.50	1.75	5.50	2.0	4.0	12.0	12.0	3.50

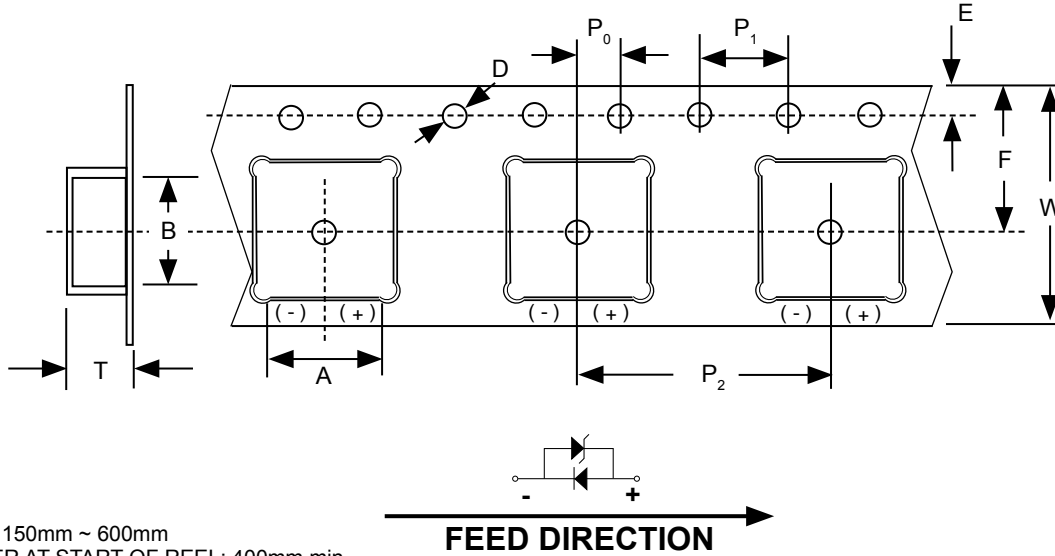

TAPE LEADER: 150mm ~ 600mm  
 EMPTY CARRIER AT START OF REEL: 400mm min.  
 EMPTY CARRIER AT END OF REEL: 200mm min.

### REEL DIMENSIONS (mm)

Type	A ± 2.0	B ± 2.0	C ± 2.0	D ± 0.8	W ± 2.0	Qty/Reel
NUVA35	φ203	φ60	φ13.0	φ21.0	13.0	500 max.

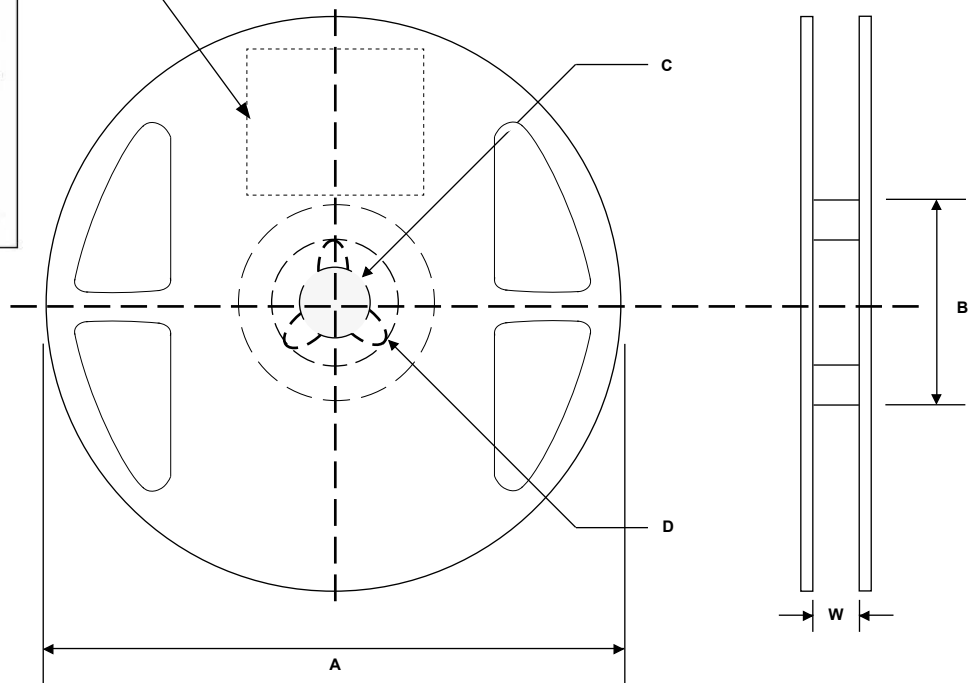
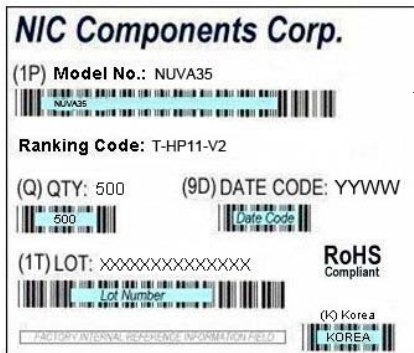

®

**Precautions for storage, handling and use of UV LED components****Storage Conditions:**

Before opening moisture barrier bag: 5°C ~ 30°C 50% RH. Use within 1 year from the delivery date

After opening moisture barrier bag: 5°C ~ 30°C 60% RH. Solder with 672 hours

Baking conditions: 65°C ± 5° 10% RH 10 ~ 24 hours

**ESD Precautions:**

LEDs are sensitive to static electricity or surge voltage and current. Electrostatic discharge can damage LED components and affect component reliability. When handling LEDs the following measures against ESD are recommended :

1. Wear a wrist strap, anti-static clothes, foot wear and gloves.
  2. Set up a grounded or anti-static paint floors, a grounded or the ability to surge protection workstation equipment and tools.
  3. Work tables and benches should have surface mat made of a conductive materials. Appropriate grounding is required for all devices, equipment, and machinery used in the product assembly.
  4. Incorporate surge protection when reviewing the design of products (Curing Module, etc).
  5. If tools or equipment contain insulating materials such as glass or plastics are used the following measures against ESD are strongly recommended :
    - a. Dissipating static charge with conductive materials
    - b. Preventing charge generation with moisture
    - c. Plug in the ionizing blowers(ionizer) for neutralizing the charge
    - d. The customer is advised to check if the LEDs are damaged by ESD when performing the characteristics inspection of the LEDs in the application.
    - e. Damage of LED can be detected with a forward voltage checking(measuring) at low current( $\leq 1\text{mA}$ ). LEDs damaged by ESD may have a current flow at a low voltage.
- \* Failure Criteria :  $V_F < 2.0V$  at  $I_f = 0.5\text{mA}$ .

### **Cleaning:**

1. Do not use brushes for cleaning or organic solvents (i.e. Acetone, TCE, etc..) for washing as they may damage the resin of the LEDs.
2. Isopropyl Alcohol(IPA) is the recommended solvent for cleaning the LEDs under the following conditions.
3. Cleaning Condition : IPA, 25°C max. × 60sec max.
4. Ultrasonic cleaning is **not** recommended.
5. Pretests should be conducted with the actual cleaning process to validate that the process will not damage the LEDs.

### **Manual handling and soldering:**

1. Use Teflon-type tweezers to grab the base of the LED and do not apply mechanical pressure on the surface of the encapsulant.
2. The recommended soldering iron condition is 260°C for <5 seconds. For higher temperatures a short contact time is required (reduce duration 1 second for every 10°C increase in temperature).
3. The power dissipation of the soldering iron should be lower than 15W and the surface temperature of the device should be controlled to  $\leq 230^{\circ}\text{C}$

### **Usage:**

1. The LED should not come into direct contact with hazardous materials such as sulfur, chlorine, phthalate, etc.
2. The metal parts on the LED can rust when exposed to corrosive gases. Therefore, exposure to corrosive gases must be avoided during operation and storage.
3. The silver-plated metal parts also can be affected not only by the corrosive gases emitted inside of the end-products but by the gases penetrated from outside environment.
4. Extreme environments such as sudden ambient temperature changes or high humidity that can cause condensation must be avoided.
5. Do not directly look at the light when the LEDs are on. Proceed with caution to avoid the risk of damage to the eyes when examining the LEDs with optical instruments.