

1N4001, 1N4002, 1N4003, 1N4004, 1N4005, 1N4006, 1N4007

Axial-Lead Glass Passivated Standard Recovery Rectifiers

This data sheet provides information on subminiature size, axial lead mounted rectifiers for general-purpose low-power applications.

Features

- Shipped in Plastic Bags, 1000 per bag
- Available Tape and Reeled, 5000 per reel, by adding a “RL” suffix to the part number
- Available in Fan-Fold Packaging, 3000 per box, by adding a “FF” suffix to the part number
- Pb-Free Packages are Available

Mechanical Characteristics

- Case: Epoxy, Molded
- Weight: 0.4 gram (approximately)
- Finish: All External Surfaces Corrosion Resistant and Terminal Leads are Readily Solderable
- Lead and Mounting Surface Temperature for Soldering Purposes: 260°C Max. for 10 Seconds, 1/16 in. from case
- Polarity: Cathode Indicated by Polarity Band

*For additional information on our Pb-Free strategy and soldering details, please download the ON Semiconductor Soldering and Mounting Techniques Reference Manual, SOLDERRM/D.



ON Semiconductor®

www.onsemi.com

LEAD MOUNTED RECTIFIERS 50–1000 VOLTS DIFFUSED JUNCTION

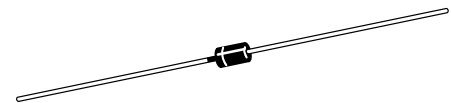

CASE 59-10
AXIAL LEAD
PLASTIC

MARKING DIAGRAM

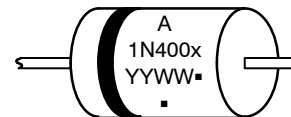

A = Assembly Location
1N400x = Device Number
x = 1, 2, 3, 4, 5, 6 or 7
YY = Year
WW = Work Week
■ = Pb-Free Package
(Note: Microdot may be in either location)

ORDERING INFORMATION

See detailed ordering and shipping information on page 5 of this data sheet.

1N4001, 1N4002, 1N4003, 1N4004, 1N4005, 1N4006, 1N4007

MAXIMUM RATINGS

Rating	Symbol	1N4001	1N4002	1N4003	1N4004	1N4005	1N4006	1N4007	Unit
†Peak Repetitive Reverse Voltage Working Peak Reverse Voltage DC Blocking Voltage	V_{RRM} V_{RWM} V_R	50	100	200	400	600	800	1000	V
†Non-Repetitive Peak Reverse Voltage (halfwave, single phase, 60 Hz)	V_{RSM}	60	120	240	480	720	1000	1200	V
†RMS Reverse Voltage	$V_{R(RMS)}$	35	70	140	280	420	560	700	V
†Average Rectified Forward Current (single phase, resistive load, 60 Hz, $T_A = 75^\circ\text{C}$)	I_O	1.0							A
†Non-Repetitive Peak Surge Current (surge applied at rated load conditions)	I_{FSM}	30 (for 1 cycle)							A
Operating and Storage Junction Temperature Range	T_J T_{stg}	-65 to +175							$^\circ\text{C}$

Stresses exceeding those listed in the Maximum Ratings table may damage the device. If any of these limits are exceeded, device functionality should not be assumed, damage may occur and reliability may be affected.

†Indicates JEDEC Registered Data

THERMAL CHARACTERISTICS

Rating	Symbol	Max	Unit
Maximum Thermal Resistance, Junction-to-Ambient	$R_{\theta JA}$	Note 1	$^\circ\text{C}/\text{W}$

ELECTRICAL CHARACTERISTICS†

Rating	Symbol	Typ	Max	Unit
Maximum Instantaneous Forward Voltage Drop, ($I_F = 1.0$ Amp, $T_J = 25^\circ\text{C}$)	V_F	0.93	1.1	V
Maximum Full-Cycle Average Forward Voltage Drop, ($I_O = 1.0$ Amp, $T_L = 75^\circ\text{C}$, 1 inch leads)	$V_{F(AV)}$	-	0.8	V
Maximum Reverse Current (rated DC voltage) ($T_J = 25^\circ\text{C}$) ($T_J = 100^\circ\text{C}$)	I_R	0.05 1.0	10 50	μA
Maximum Full-Cycle Average Reverse Current, ($I_O = 1.0$ Amp, $T_L = 75^\circ\text{C}$, 1 inch leads)	$I_{R(AV)}$	-	30	μA

Product parametric performance is indicated in the Electrical Characteristics for the listed test conditions, unless otherwise noted. Product performance may not be indicated by the Electrical Characteristics if operated under different conditions.

†Indicates JEDEC Registered Data

1N4001, 1N4002, 1N4003, 1N4004, 1N4005, 1N4006, 1N4007

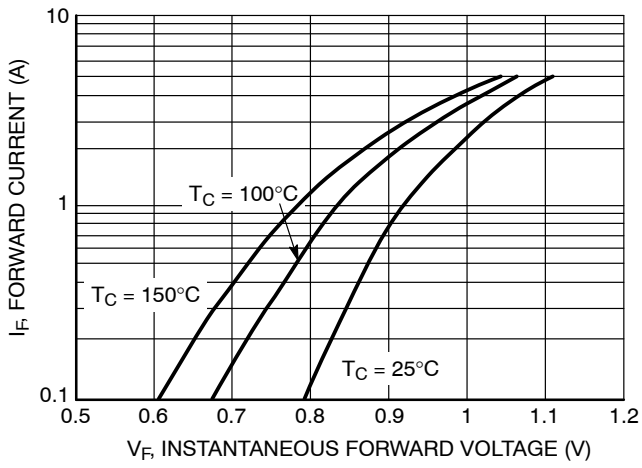

Figure 1. Typical Forward Voltage

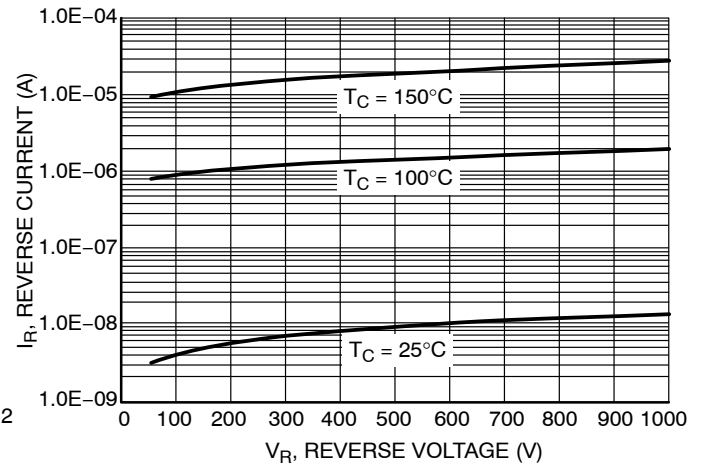

Figure 2. Typical Reverse Current

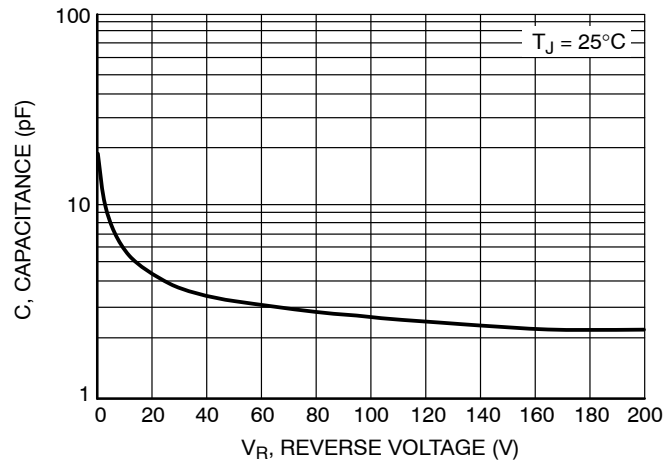

Figure 3. Typical Capacitance

NOTE 1. – AMBIENT MOUNTING DATA

Data shown for thermal resistance, junction-to-ambient ($R_{\theta JA}$) for the mountings shown is to be used as typical guideline values for preliminary engineering or in case the tie point temperature cannot be measured.

TYPICAL VALUES FOR $R_{\theta JA}$ IN STILL AIR

Mounting Method	$R_{\theta JA}$	Lead Length, L			Units
		1/8	1/4	1/2	
1		52	65	72	°C/W
2		67	80	87	°C/W
3		50			°C/W

MOUNTING METHOD 1

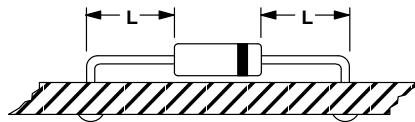

MOUNTING METHOD 2

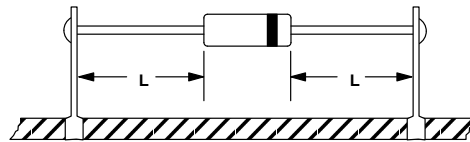

Vector Pin Mounting

MOUNTING METHOD 3

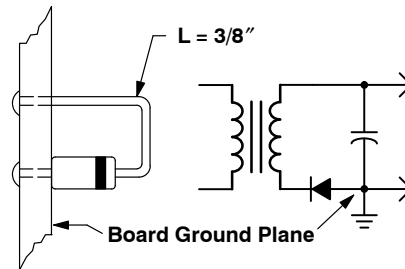

P.C. Board with
1-1/2" X 1-1/2" Copper Surface

1N4001, 1N4002, 1N4003, 1N4004, 1N4005, 1N4006, 1N4007

ORDERING INFORMATION

Device	Package	Shipping†
1N4001	Axial Lead*	1000 Units/Bag
1N4001G	Axial Lead* (Pb-Free)	1000 Units/Bag
1N4001FF	Axial Lead*	3000 Units/Box
1N4001FFG	Axial Lead* (Pb-Free)	3000 Units/Box
1N4001RL	Axial Lead*	5000/Tape & Reel
1N4001RLG	Axial Lead* (Pb-Free)	5000/Tape & Reel
1N4002	Axial Lead*	1000 Units/Bag
1N4002G	Axial Lead* (Pb-Free)	1000 Units/Bag
1N4002FF	Axial Lead*	3000 Units/Box
1N4002FFG	Axial Lead* (Pb-Free)	3000 Units/Box
1N4002RL	Axial Lead*	5000/Tape & Reel
1N4002RLG	Axial Lead* (Pb-Free)	5000/Tape & Reel
1N4003	Axial Lead*	1000 Units/Bag
1N4003G	Axial Lead* (Pb-Free)	1000 Units/Bag
1N4003FF	Axial Lead*	3000 Units/Box
1N4003FFG	Axial Lead* (Pb-Free)	3000 Units/Box
1N4003RL	Axial Lead*	5000/Tape & Reel
1N4003RLG	Axial Lead* (Pb-Free)	5000/Tape & Reel
1N4004	Axial Lead*	1000 Units/Bag
1N4004G	Axial Lead* (Pb-Free)	1000 Units/Bag
1N4004FF	Axial Lead*	3000 Units/Box
1N4004FFG	Axial Lead* (Pb-Free)	3000 Units/Box
1N4004RL	Axial Lead*	5000/Tape & Reel
1N4004RLG	Axial Lead* (Pb-Free)	5000/Tape & Reel
1N4005	Axial Lead*	1000 Units/Bag
1N4005G	Axial Lead* (Pb-Free)	1000 Units/Bag
1N4005FF	Axial Lead*	3000 Units/Box
1N4005FFG	Axial Lead* (Pb-Free)	3000 Units/Box
1N4005RL	Axial Lead*	5000/Tape & Reel
1N4005RLG	Axial Lead* (Pb-Free)	5000/Tape & Reel

†For information on tape and reel specifications, including part orientation and tape sizes, please refer to our Tape and Reel Packaging Specifications Brochure, BRD8011/D.

*This package is inherently Pb-Free.

1N4001, 1N4002, 1N4003, 1N4004, 1N4005, 1N4006, 1N4007

ORDERING INFORMATION

Device	Package	Shipping†
1N4006	Axial Lead*	1000 Units/Bag
1N4006G	Axial Lead* (Pb-Free)	1000 Units/Bag
1N4006FF	Axial Lead*	3000 Units/Box
1N4006FFG	Axial Lead* (Pb-Free)	3000 Units/Box
1N4006RL	Axial Lead*	5000/Tape & Reel
1N4006RLG	Axial Lead* (Pb-Free)	5000/Tape & Reel
1N4007	Axial Lead*	1000 Units/Bag
1N4007G	Axial Lead* (Pb-Free)	1000 Units/Bag
1N4007FF	Axial Lead*	3000 Units/Box
1N4007FFG	Axial Lead* (Pb-Free)	3000 Units/Box
1N4007RL	Axial Lead*	5000/Tape & Reel
1N4007RLG	Axial Lead* (Pb-Free)	5000/Tape & Reel

†For information on tape and reel specifications, including part orientation and tape sizes, please refer to our Tape and Reel Packaging Specifications Brochure, BRD8011/D.

*This package is inherently Pb-Free.

MECHANICAL CASE OUTLINE

PACKAGE DIMENSIONS



AXIAL LEAD CASE 59-10 ISSUE U

DATE 15 FEB 2005

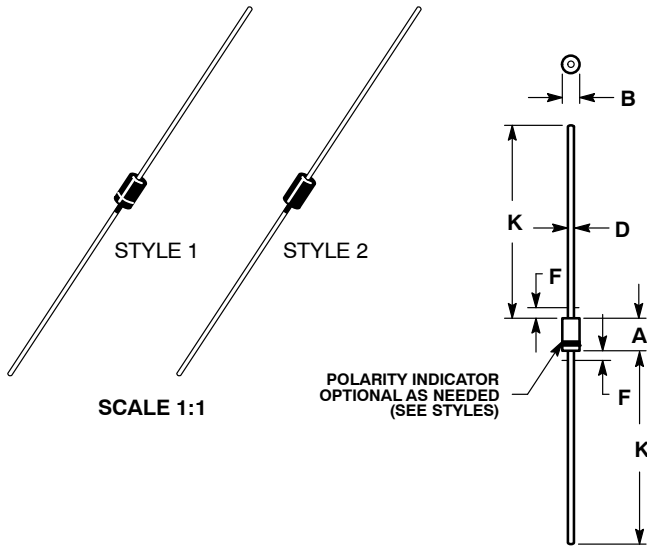

SCALE 1:1

POLARITY INDICATOR
OPTIONAL AS NEEDED
(SEE STYLES)

STYLE 1:
PIN 1. CATHODE (POLARITY BAND)
2. ANODE

STYLE 2:
NO POLARITY

NOTES:

1. DIMENSIONING AND TOLERANCING PER ANSI Y14.5M, 1982.
2. CONTROLLING DIMENSION: INCH.
3. ALL RULES AND NOTES ASSOCIATED WITH JEDEC DO-41 OUTLINE SHALL APPLY
4. POLARITY DENOTED BY CATHODE BAND.
5. LEAD DIAMETER NOT CONTROLLED WITHIN F DIMENSION.

DIM	INCHES		MILLIMETERS	
	MIN	MAX	MIN	MAX
A	0.161	0.205	4.10	5.20
B	0.079	0.106	2.00	2.70
D	0.028	0.034	0.71	0.86
F	---	0.050	---	1.27
K	1.000	---	25.40	---

GENERIC MARKING DIAGRAM*

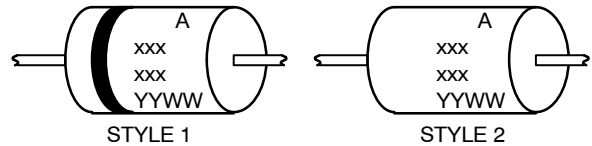

- xxx = Specific Device Code
- A = Assembly Location
- YY = Year
- WW = Work Week

*This information is generic. Please refer to device data sheet for actual part marking. Pb-Free indicator, "G" or microdot "▪", may or may not be present.

DOCUMENT NUMBER:	98ASB42045B	Electronic versions are uncontrolled except when accessed directly from the Document Repository. Printed versions are uncontrolled except when stamped "CONTROLLED COPY" in red.
DESCRIPTION:	AXIAL LEAD	PAGE 1 OF 1

ON Semiconductor and are trademarks of Semiconductor Components Industries, LLC dba ON Semiconductor or its subsidiaries in the United States and/or other countries. ON Semiconductor reserves the right to make changes without further notice to any products herein. ON Semiconductor makes no warranty, representation or guarantee regarding the suitability of its products for any particular purpose, nor does ON Semiconductor assume any liability arising out of the application or use of any product or circuit, and specifically disclaims any and all liability, including without limitation special, consequential or incidental damages. ON Semiconductor does not convey any license under its patent rights nor the rights of others.

ON Semiconductor and  are trademarks of Semiconductor Components Industries, LLC dba ON Semiconductor or its subsidiaries in the United States and/or other countries. ON Semiconductor owns the rights to a number of patents, trademarks, copyrights, trade secrets, and other intellectual property. A listing of ON Semiconductor's product/patent coverage may be accessed at www.onsemi.com/site/pdf/Patent-Marking.pdf. ON Semiconductor reserves the right to make changes without further notice to any products herein. ON Semiconductor makes no warranty, representation or guarantee regarding the suitability of its products for any particular purpose, nor does ON Semiconductor assume any liability arising out of the application or use of any product or circuit, and specifically disclaims any and all liability, including without limitation special, consequential or incidental damages. Buyer is responsible for its products and applications using ON Semiconductor products, including compliance with all laws, regulations and safety requirements or standards, regardless of any support or applications information provided by ON Semiconductor. "Typical" parameters which may be provided in ON Semiconductor data sheets and/or specifications can and do vary in different applications and actual performance may vary over time. All operating parameters, including "Typicals" must be validated for each customer application by customer's technical experts. ON Semiconductor does not convey any license under its patent rights nor the rights of others. ON Semiconductor products are not designed, intended, or authorized for use as a critical component in life support systems or any FDA Class 3 medical devices or medical devices with a same or similar classification in a foreign jurisdiction or any devices intended for implantation in the human body. Should Buyer purchase or use ON Semiconductor products for any such unintended or unauthorized application, Buyer shall indemnify and hold ON Semiconductor and its officers, employees, subsidiaries, affiliates, and distributors harmless against all claims, costs, damages, and expenses, and reasonable attorney fees arising out of, directly or indirectly, any claim of personal injury or death associated with such unintended or unauthorized use, even if such claim alleges that ON Semiconductor was negligent regarding the design or manufacture of the part. ON Semiconductor is an Equal Opportunity/Affirmative Action Employer. This literature is subject to all applicable copyright laws and is not for resale in any manner.

PUBLICATION ORDERING INFORMATION

LITERATURE FULFILLMENT:

Email Requests to: orderlit@onsemi.com

ON Semiconductor Website: www.onsemi.com

TECHNICAL SUPPORT

North American Technical Support:
Voice Mail: 1 800-282-9855 Toll Free USA/Canada
Phone: 011 421 33 790 2910

Europe, Middle East and Africa Technical Support:

Phone: 00421 33 790 2910

For additional information, please contact your local Sales Representative