

Printed-circuit board connector - GFKC 2,5/ 2-ST-7,62 - 1939633

Please be informed that the data shown in this PDF Document is generated from our Online Catalog. Please find the complete data in the user's documentation. Our General Terms of Use for Downloads are valid (<http://phoenixcontact.com/download>)

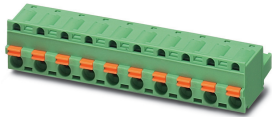

The figure shows a 10-position version of the product

PCB connector, nominal cross section: 2.5 mm², color: green, nominal current: 12 A, rated voltage (III/2): 630 V, contact surface: Tin, type of contact: Female connector, Number of potentials: 2, Number of rows: 1, Number of positions per row: 2, number of connections: 2, product range: GFKC 2,5/..-ST, pitch: 7.62 mm, connection method: Push-in spring connection, conductor/PCB connection direction: 0 °, Locking clip: - Locking clip, Stecksystem: CLASSIC COMBICON, Locking: without, type of packaging: packed in cardboard, COMBICON connectors may only be activated under no load conditions. If for operating reasons small loads must be switched, experimental values are available upon request.

Your advantages

- ✓ Time saving push-in connection, tools not required
- ✓ Defined contact force ensures that contact remains stable over the long term
- ✓ Intuitive use through colour coded actuation lever
- ✓ Integrated double steel spring provides additional safety in the event of temperature and power fluctuations

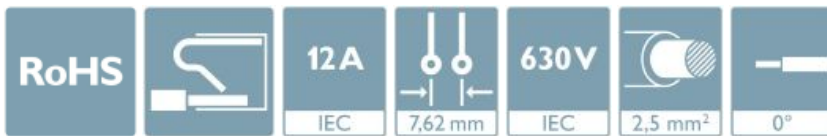

Key Commercial Data

Packing unit	1 pc
Minimum order quantity	50 pc
GTIN	
GTIN	4017918877699
Weight per Piece (excluding packing)	4.390 g
Custom tariff number	85366990
Country of origin	Germany

Technical data

Item properties

Brief article description	PCB connector
Plug-in system	CLASSIC COMBICON
Type of contact	Female connector

Printed-circuit board connector - GFKC 2,5/ 2-ST-7,62 - 1939633

Technical data

Item properties

Range of articles	GFKC 2,5/..-ST
Pitch	7.62 mm
Number of positions	2
Locking	without
Number of levels	1
Number of connections	2
Number of potentials	2

Electrical parameters

Nominal current	12 A
Nom. voltage	630 V
Rated voltage (III/3)	400 V
Rated voltage (III/2)	630 V
Rated voltage (II/2)	1000 V
Rated surge voltage (III/3)	6 kV
Rated surge voltage (III/2)	6 kV
Rated surge voltage (II/2)	6 kV

Connection capacity

Connection method	Push-in spring connection
pluggable	Yes
Conductor cross section solid	0.2 mm ² ... 2.5 mm ²
Conductor cross section flexible	0.2 mm ² ... 2.5 mm ²
Conductor cross section AWG / kcmil	24 ... 12
Conductor cross section flexible, with ferrule without plastic sleeve	0.25 mm ² ... 2.5 mm ²
Conductor cross section, flexible, with ferrule, with plastic sleeve	0.25 mm ² ... 2.5 mm ²
2 conductors with the same cross section, flexible, with TWIN ferrule with plastic sleeve	0.5 mm ² ... 1.5 mm ²
Cylindrical gauge a x b / diameter	2.8 mm x 2.0 mm / 2.4 mm
Stripping length	10 mm

Specifications for ferrules

Recommended crimping pliers	1212034 CRIMPFOX 6
Ferrules without insulating collar, according to DIN46228-1	Cross section:0.5 mm ² ; Length: 8 mm ... 10 mm
	Cross section:0.75 mm ² ; Length: 8 mm ... 10 mm
	Cross section:1 mm ² ; Length: 8 mm ... 10 mm
	Cross section:1.5 mm ² ; Length: 8 mm ... 10 mm
	Cross section:2.5 mm ² ; Length: 10 mm
Recommended crimping pliers	1212034 CRIMPFOX 6

Printed-circuit board connector - GFKC 2,5/ 2-ST-7,62 - 1939633

Technical data

Specifications for ferrules

Ferrules with insulating collar, according to DIN46228-4	Cross section:0.5 mm ² ; Length: 8 mm ... 10 mm
	Cross section:0.75 mm ² ; Length: 8 mm ... 10 mm
	Cross section:1 mm ² ; Length: 8 mm ... 10 mm
	Cross section:1.5 mm ² ; Length: 8 mm ... 10 mm
	Cross section:2.5 mm ² ; Length: 10 mm

Material data - contact

Note	WEEE/RoHS-compliant, free of whiskers according to IEC 60068-2-82/ JEDEC JESD 201
Contact material	Cu alloy
Surface characteristics	hot-dip tin-plated
Metal surface terminal point (top layer)	Tin (4 - 8 µm Sn)
Metal surface contact area (top layer)	Tin (4 - 8 µm Sn)

Material data - housing

Housing color	green (6021)
Insulating material	PA
Insulating material group	I
CTI according to IEC 60112	600
Flammability rating according to UL 94	V0
Glow wire flammability index GWFI according to EN 60695-2-12	850
Glow wire ignition temperature GWIT according to EN 60695-2-13	775
Temperature for the ball pressure test according to EN 60695-10-2	125 °C

Material data – actuating element

Color of the actuating lever	orange (2003)
Insulating material	PBT
CTI according to IEC 60112	600
Flammability rating according to UL 94	V0

Dimensions for the product

Caption	Schematische Abbildung - weitere Details siehe Produktfamilienzeichnung im Download Center
Length [l]	25.56 mm
Width [w]	13.32 mm
Height [h]	15 mm
Pitch	7.62 mm
Height (without solder pin)	15 mm

Packaging information

Type of packaging	packed in cardboard
-------------------	---------------------

Printed-circuit board connector - GFKC 2,5/ 2-ST-7,62 - 1939633

Technical data

Packaging information

Pieces per package	50
Denomination packing units	Pcs.

General product information

Note	In accordance with IEC 61984, COMBICON connectors have no switching power (COC). During designated use, they must not be plugged in or disconnected when carrying voltage or under load.
------	--

Termination and connection method

Conductor connection test	The stripped-off ends of the largest conductor can be completely inserted in the opening of the terminal point without using excessive force.
Test result	Test passed
Test – repeated connection and release	IEC 60999-1:1999-11
	Test passed
Test for conductor damage and slackening	IEC 60999-1:1999-11
	Test passed

Pull-out test

Pull-out test	IEC 60999-1:1999-11
Conductor cross section / conductor type / tensile force	0.2 mm ² / solid / > 10 N
	0.2 mm ² / flexible / > 10 N
	2.5 mm ² / solid / > 50 N
	2.5 mm ² / flexible / > 50 N

Mechanical tests according to standard

Test specification	IEC 61984
Visual inspection	IEC 60512-1-1:2002-02
Dimension check	IEC 60512-1-2:2002-02
Resistance of inscriptions	IEC 60068-2-70:1995-12
Insertion and withdrawal force	IEC 60512-13-2:2006-02
No. of cycles	25
Insertion strength per pos. approx.	8 N
Withdraw strength per pos. approx.	6 N
Polarization and coding	IEC 60512-13-5:2006-02
Contact holder in insert	IEC 60512-15-1:2008-05
Test force per pos.	36 N

Air clearances and creepage distances

Clearances and creepage distances	IEC 60664-1:2007-04
Specification	IEC 60664-1:2007-04
Minimum clearance - inhomogeneous field (III/3)	5.5 mm

Printed-circuit board connector - GFKC 2,5/ 2-ST-7,62 - 1939633

Technical data

Air clearances and creepage distances

Minimum clearance - inhomogeneous field (III/2)	5.5 mm
Minimum clearance - inhomogeneous field (II/2)	5.5 mm
Minimum creepage distance value (III/3)	5.5 mm
Minimum creepage distance value (III/2)	5.5 mm
Minimum creepage distance value (II/2)	5.5 mm

Current carrying capacity / derating curves

Caption	Type: GFKC 2,5/...-ST-7,62 with GMSTBA 2,5/...-G-7,62
---------	---

Mechanical tests (A)

Test specification	IEC 61984
Insertion strength per pos. approx.	8 N
Withdraw strength per pos. approx.	6 N
Polarization when inserted requirement >20 N	Test passed
Contact holder in insert requirements >20 N	Test passed

Durability tests (B)

Specification	IEC 60512-9-1:2010-03
Contact resistance R ₁	0.9 mΩ
Insertion/withdrawal cycles	25
Contact resistance R ₂	1 mΩ
Impulse withstand voltage at sea level	7.3 kV

Thermal tests (C)

Specification	IEC 60512-5-1:2002-02
Number of positions	12
Upper limiting temperature requirements <100 °C	Test passed

Climatic tests (D)

Specification	ISO 6988:1985-02
Cold stress	-40 °C/2 h
Thermal stress	100 °C/168 h
Corrosive stress	0.2 dm ³ SO ₂ on 300 dm ³ /40 °C/1 cycle
Impulse withstand voltage at sea level	7.3 kV
Power-frequency withstand voltage	3.31 kV

Environmental and durability tests (E)

Specification	IEC 61984:2008-10
Result, degree of protection, IP code	Finger safety with IP20 test finger

Environmental Product Compliance

Printed-circuit board connector - GFKC 2,5/ 2-ST-7,62 - 1939633

Technical data

Environmental Product Compliance

China RoHS	Environmentally friendly use period: unlimited = EFUP-e
	No hazardous substances above threshold values

Drawings

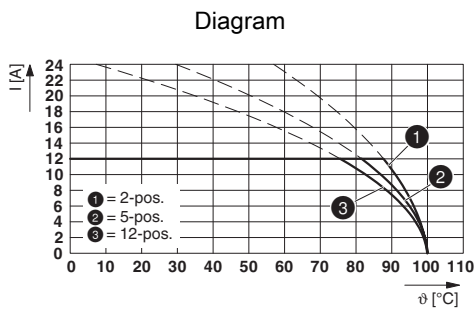

Type: GFKC 2,5/...-ST-7,62 with GMSTBA 2,5/...-G-7,62

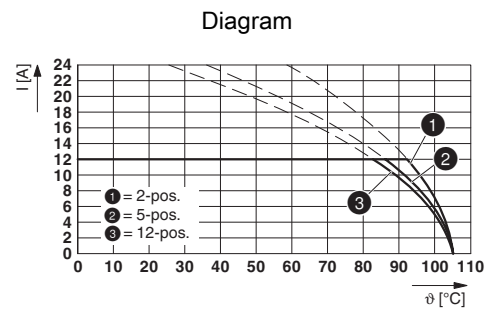

Type: GFKC 2,5/...-ST-7,62 with GMSTB 2,5/...-G-7,62

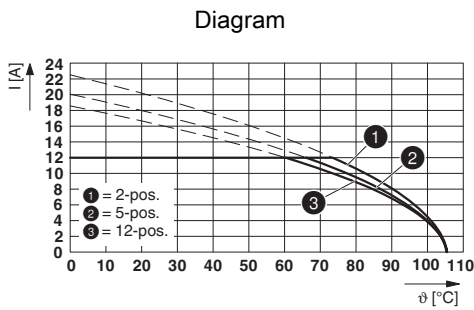

Type: GFKC 2,5/...-ST-7,62 with GMSTBV 2,5/...-G-7,62

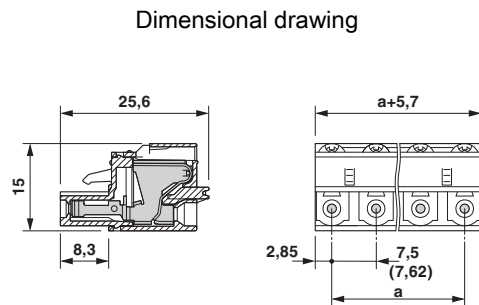

Diagram

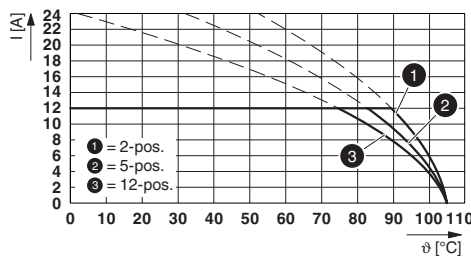

Type: GFKC 2,5/...-ST-7,62 with GIC 2,5/...-ST-7,62

Printed-circuit board connector - GFKC 2,5/ 2-ST-7,62 - 1939633

Classifications

eCl@ss

eCl@ss 10.0.1	27440309
eCl@ss 11.0	27460202
eCl@ss 4.0	27260700
eCl@ss 4.1	27260700
eCl@ss 5.0	27260700
eCl@ss 5.1	27260700
eCl@ss 6.0	27260700
eCl@ss 7.0	27440309
eCl@ss 8.0	27440309
eCl@ss 9.0	27440309

ETIM

ETIM 3.0	EC001121
ETIM 4.0	EC002638
ETIM 5.0	EC002638
ETIM 6.0	EC002638
ETIM 7.0	EC002638

UNSPSC

UNSPSC 6.01	30211810
UNSPSC 7.0901	39121409
UNSPSC 11	39121409
UNSPSC 12.01	39121409
UNSPSC 13.2	39121409
UNSPSC 18.0	39121409
UNSPSC 19.0	39121409
UNSPSC 20.0	39121409
UNSPSC 21.0	39121409

Approvals

Approvals

Approvals

CSA / IECCEB Scheme / EAC / cULus Recognized / VDE Zeichengenehmigung

Ex Approvals

Printed-circuit board connector - GFKC 2,5/ 2-ST-7,62 - 1939633

Approvals

Approval details

CSA		http://www.csagroup.org/services-industries/product-listing/	13631
	B	D	
Nominal voltage UN	300 V	300 V	
Nominal current IN	12 A	10 A	
mm ² /AWG/kcmil	24-12	24-12	

IECEE CB Scheme		http://www.iecee.org/	DE1-60988-B1B2
Nominal voltage UN	400 V		
Nominal current IN	12 A		
mm ² /AWG/kcmil	0.2-2.5		

EAC		B.01687
-----	---	---------

cULus Recognized		http://database.ul.com/cgi-bin/XYV/template/LISEXT/1FRAME/index.htm	E60425-19931013
	B	D	
Nominal voltage UN	300 V	300 V	
Nominal current IN	10 A	10 A	
mm ² /AWG/kcmil	26-12	26-12	

VDE Zeichengenehmigung		http://www2.vde.com/de/Institut/Online-Service/VDE-gepruefteProdukte/Seiten/Online-Suche.aspx	40050646
Nominal voltage UN	400 V		
Nominal current IN	12 A		
mm ² /AWG/kcmil	0.2-2.5		

Printed-circuit board connector - GFKC 2,5/ 2-ST-7,62 - 1939633

Accessories

Additional products

Feed-through header - GMSTB 2,5/ 2-G-7,62 - 1766123

PCB header, nominal cross section: 2.5 mm², color: green, nominal current: 12 A, rated voltage (III/2): 630 V, contact surface: Tin, type of contact: Male connector, Number of potentials: 2, Number of rows: 1, Number of positions per row: 2, number of connections: 2, product range: GMSTB 2,5/..-G, pitch: 7.62 mm, mounting: Wave soldering, pin layout: Linear pinning, solder pin [P]: 3.2 mm, Stecksystem: CLASSIC COMBICON, Locking: without, type of packaging: packed in cardboard



Feed-through header - GMSTBA 2,5/ 2-G-7,62 - 1766233

PCB header, nominal cross section: 2.5 mm², color: green, nominal current: 12 A, rated voltage (III/2): 630 V, contact surface: Tin, type of contact: Male connector, Number of potentials: 2, Number of rows: 1, Number of positions per row: 2, number of connections: 2, product range: GMSTBA 2,5/..-G, pitch: 7.62 mm, mounting: Wave soldering, pin layout: Linear pinning, solder pin [P]: 3.2 mm, Stecksystem: CLASSIC COMBICON, Locking: without, type of packaging: packed in cardboard



Feed-through header - GMSTBV 2,5/ 2-G-7,62 - 1766563

PCB header, nominal cross section: 2.5 mm², color: green, nominal current: 12 A, rated voltage (III/2): 630 V, contact surface: Tin, type of contact: Male connector, Number of potentials: 2, Number of rows: 1, Number of positions per row: 2, number of connections: 2, product range: GMSTBV 2,5/..-G, pitch: 7.62 mm, mounting: Wave soldering, pin layout: Linear pinning, solder pin [P]: 3.9 mm, Stecksystem: CLASSIC COMBICON, Locking: without, type of packaging: packed in cardboard



Feed-through header - GMSTBVA 2,5/ 2-G-7,62 - 1766770

PCB header, nominal cross section: 2.5 mm², color: green, nominal current: 12 A, rated voltage (III/2): 630 V, contact surface: Tin, type of contact: Male connector, Number of potentials: 2, Number of rows: 1, Number of positions per row: 2, number of connections: 2, product range: GMSTBVA 2,5/..-G, pitch: 7.62 mm, mounting: Wave soldering, pin layout: Linear pinning, solder pin [P]: 3.9 mm, Stecksystem: CLASSIC COMBICON, Locking: without, type of packaging: packed in cardboard

