

## Printed-circuit board connector - MCD 1,5/ 5-G1-3,81 - 1843101

Please be informed that the data shown in this PDF Document is generated from our Online Catalog. Please find the complete data in the user's documentation. Our General Terms of Use for Downloads are valid (<http://phoenixcontact.com/download>)

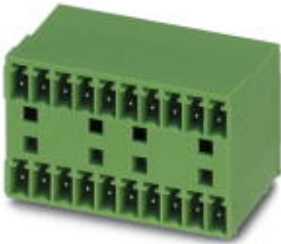

PCB headers, nominal current: 8 A, number of positions: 5, pitch: 3.81 mm, color: green, contact surface: Tin, mounting: Wave soldering, In combination with MCV plug components, both an MCVW and an MCVR plug must be used.

The figure shows a 10-pos. version with 20 contacts

### Your advantages

- ✓ Well-known mounting principle allows worldwide use
- ✓ Conductor connection on several levels enables higher contact density
- ✓ Maximum flexibility when it comes to device design – one header for connectors with different connection technologies



### Key Commercial Data

Packing unit	1 pc
Minimum order quantity	50 pc
GTIN	
GTIN	4017918112295
Weight per Piece (excluding packing)	6.670 g
Custom tariff number	85366930
Country of origin	Germany

### Technical data

#### Dimensions

Length [ l ]	21.9 mm
Width	20.44 mm
Pitch	3.81 mm
Dimension a	15.24 mm

# Printed-circuit board connector - MCD 1,5/ 5-G1-3,81 - 1843101

## Technical data

### Dimensions

Width [ w ]	20.44 mm
Height [ h ]	26.2 mm
Height	22.7 mm
Length of the solder pin	3.5 mm
Pin dimensions	0.8 x 0.8 mm
Pin spacing	12.70 mm
Length	21.9 mm

### General

Range of articles	MCD 1,5/...-G1
Insulating material group	I
Rated surge voltage (III/3)	2.5 kV
Rated surge voltage (III/2)	2.5 kV
Rated surge voltage (II/2)	2.5 kV
Rated voltage (III/3)	160 V
Rated voltage (III/2)	160 V
Rated voltage (II/2)	320 V
Connection in acc. with standard	EN-VDE
Nominal current I <sub>N</sub>	8 A
Maximum load current	8 A
Insulating material	PA
Flammability rating according to UL 94	V0
Color	green
Number of positions	5

### Standards and Regulations

Connection in acc. with standard	EN-VDE
	CSA
Flammability rating according to UL 94	V0

### Environmental Product Compliance

China RoHS	Environmentally friendly use period: unlimited = EFUP-e
	No hazardous substances above threshold values

## Drawings

# Printed-circuit board connector - MCD 1,5/ 5-G1-3,81 - 1843101

Drilling diagram

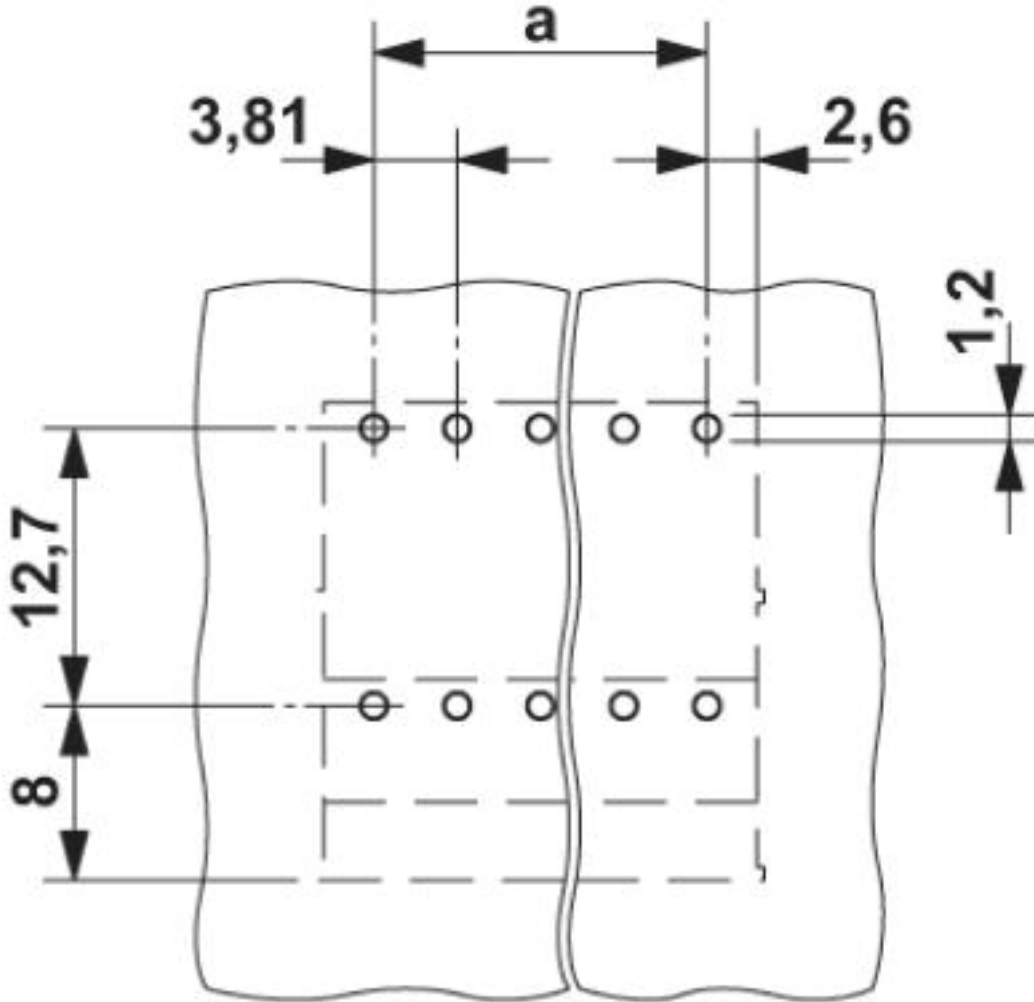

# Printed-circuit board connector - MCD 1,5/ 5-G1-3,81 - 1843101

Diagram

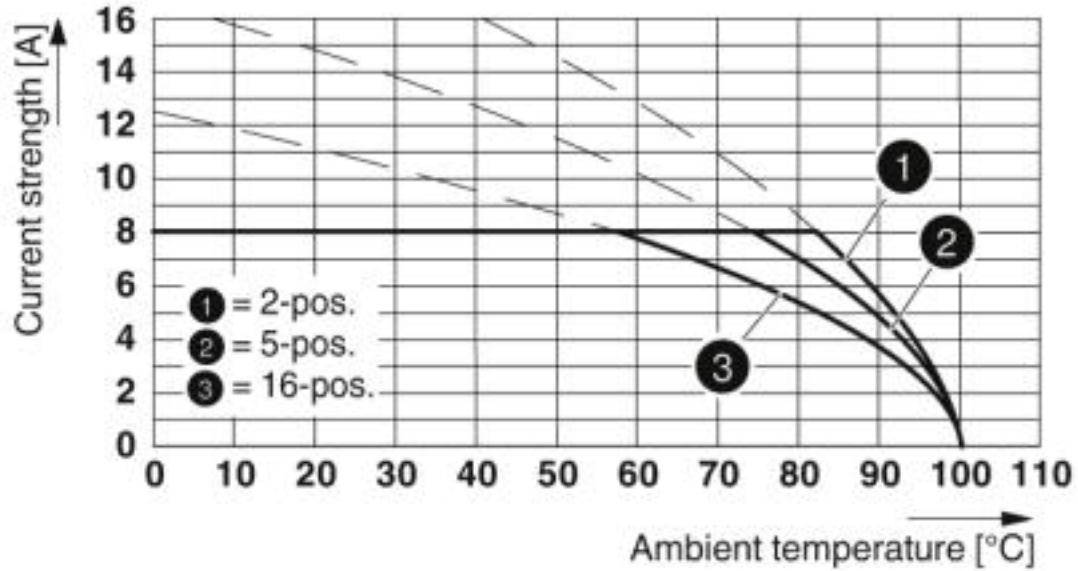

Type: MC 1,5/...-ST-3,81 with MCD 1,5/...-G1-3,81

Dimensional drawing

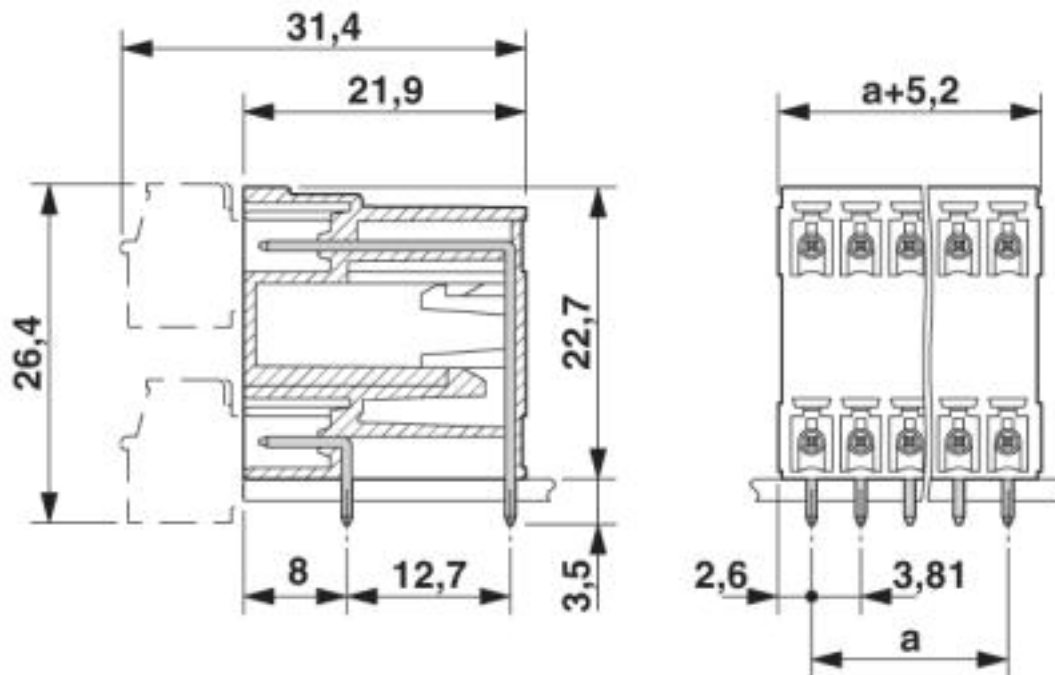

# Printed-circuit board connector - MCD 1,5/ 5-G1-3,81 - 1843101

## Classifications

### eCl@ss

eCl@ss 4.0	27260700
eCl@ss 4.1	27260700
eCl@ss 5.0	27260700
eCl@ss 5.1	27260700
eCl@ss 6.0	27260700
eCl@ss 7.0	27440402
eCl@ss 8.0	27440402
eCl@ss 9.0	27440402

### ETIM

ETIM 3.0	EC001121
ETIM 4.0	EC002637
ETIM 5.0	EC002637
ETIM 6.0	EC002637
ETIM 7.0	EC002637

### UNSPSC

UNSPSC 6.01	30211810
UNSPSC 7.0901	39121409
UNSPSC 11	39121409
UNSPSC 12.01	39121409
UNSPSC 13.2	39121409

## Approvals

### Approvals

---

#### Approvals

CSA / IEC EE CB Scheme / VDE Gutachten mit Fertigungsüberwachung / EAC / cULus Recognized

---

#### Ex Approvals

---

### Approval details

# Printed-circuit board connector - MCD 1,5/ 5-G1-3,81 - 1843101

## Approvals

CSA		<a href="http://www.csagroup.org/services-industries/product-listing/">http://www.csagroup.org/services-industries/product-listing/</a>	13631
	B	D	
Nominal voltage UN	300 V	300 V	
Nominal current IN	8 A	8 A	

IECEE CB Scheme		<a href="http://www.iecee.org/">http://www.iecee.org/</a>	DE1-60987-B1B2
Nominal voltage UN	160 V		
Nominal current IN	8 A		

VDE Gutachten mit Fertigungsüberwachung		<a href="http://www2.vde.com/de/Institut/Online-Service/VDE-gepruefteProdukte/Seiten/Online-Suche.aspx">http://www2.vde.com/de/Institut/Online-Service/VDE-gepruefteProdukte/Seiten/Online-Suche.aspx</a>	40011723
Nominal voltage UN	160 V		
Nominal current IN	8 A		

EAC			B.01742
-----	---	--	---------

cULus Recognized		<a href="http://database.ul.com/cgi-bin/XYV/template/LISEXT/1FRAME/index.htm">http://database.ul.com/cgi-bin/XYV/template/LISEXT/1FRAME/index.htm</a>	E60425-20110128
	B	D	
Nominal voltage UN	300 V	300 V	
Nominal current IN	8 A	8 A	

## Accessories

Accessories

Coding element

## Printed-circuit board connector - MCD 1,5/ 5-G1-3,81 - 1843101

### Accessories

Coding profile - CP-MSTB - 1734634

Coding profile, is inserted into the slot on the plug or inverted header, red insulating material



---

### Labeled terminal marker

Marker card - SK 3,81/2,8:FORTL.ZAHLEN - 0804109



Marker card, Card, white, labeled, Horizontal: consecutive numbers 1 ... 10, 11 ... 20, etc. up to 91 ... (99)100, mounting type: adhesive, for terminal block width: 3.81 mm, lettering field size: 3.81 x 2.8 mm

---

### Additional products

Printed-circuit board connector - FMC 1,5/ 5-ST-3,81 - 1745920



PCB connector, nominal current: 8 A, number of positions: 5, pitch: 3.81 mm, connection method: Push-in spring connection, color: green, contact surface: Tin

---

Printed-circuit board connector - MC 1,5/ 5-ST-3,81 - 1803604



PCB connector, nominal current: 8 A, number of positions: 5, pitch: 3.81 mm, connection method: Screw connection with tension sleeve, color: green, contact surface: Tin

---

Printed-circuit board connector - MCVW 1,5/ 5-ST-3,81 - 1827004



PCB connector, nominal current: 8 A, number of positions: 5, pitch: 3.81 mm, connection method: Screw connection with tension sleeve, color: green, contact surface: Tin

## Printed-circuit board connector - MCD 1,5/ 5-G1-3,81 - 1843101

### Accessories

---

#### Printed-circuit board connector - MCVR 1,5/ 5-ST-3,81 - 1827156



PCB connector, nominal current: 8 A, number of positions: 5, pitch: 3.81 mm, connection method: Screw connection with tension sleeve, color: green, contact surface: Tin

---

#### Printed-circuit board connector - FRONT-MC 1,5/ 5-ST-3,81 - 1850699



PCB connector, nominal current: 8 A, number of positions: 5, pitch: 3.81 mm, connection method: Front screw connection, color: green, contact surface: Tin

---

#### Printed-circuit board connector - FK-MCP 1,5/ 5-ST-3,81 - 1851070

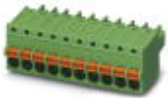

PCB connector, nominal current: 8 A, number of positions: 5, pitch: 3.81 mm, connection method: Push-in spring connection, color: green, contact surface: Tin

---

#### Printed-circuit board connector - MCC 1/ 5-STZ-3,81 - 1852202



PCB connector, nominal current: 8 A, number of positions: 5, pitch: 3.81 mm, connection method: Crimp connection, color: green, Corresponding female crimp contacts with current [A] and conductor cross section range [mm<sup>2</sup>] data: 5A/MCC-MT 0,2-0,35 (1859988); 8A/MCC-MT 0,5-1,0 (1859991)

---

#### Printed-circuit board connector - QC 0,5/ 5-ST-3,81 - 1897429



PCB connector, nominal current: 6 A, number of positions: 5, pitch: 3.81 mm, connection method: Displacement connection, color: green, contact surface: Tin

---

---



