

# Printed-circuit board connector - DMCV 1,5/ 4-G1F-3,5-LR P20THR - 1787412

Please be informed that the data shown in this PDF Document is generated from our Online Catalog. Please find the complete data in the user's documentation. Our General Terms of Use for Downloads are valid (<http://phoenixcontact.com/download>)

PCB header, nominal cross section: 1.5 mm<sup>2</sup>, color: black, nominal current: 8 A, rated voltage (III/2): 160 V, contact surface: Tin, type of contact: Male connector, Number of potentials: 8, Number of rows: 2, Number of positions per row: 4, number of connections: 8, product range: DMCV 1,5/..-G1F-THR, pitch: 3.5 mm, mounting: THR soldering, pin layout: Linear pinning, solder pin [P]: 2 mm, plug-in system: MINI COMBICON - DFMC 1,5, Locking: Snap-in locking, type of packaging: packed in cardboard

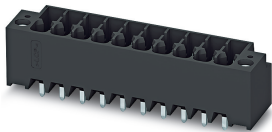

The figure shows a 10-pos. version with 20 contacts

## Your advantages

- ✔ Designed for integration into the SMT soldering process
- ✔ Vertical connection enables multi-row arrangement on the PCB
- ✔ Screwable flange for superior mechanical stability
- ✔ Automatic locking and intuitive release through Lock and Release operating lever in contrasting color
- ✔ Small component size for applications where space is at a premium

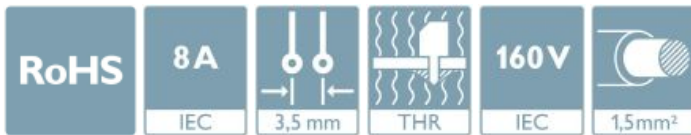

## Key Commercial Data

Packing unit	1 pc
Minimum order quantity	50 pc
GTIN	 4 046356 597036
GTIN	4046356597036
Weight per Piece (excluding packing)	5.000 g
Custom tariff number	85366930
Country of origin	Germany

## Technical data

### Item properties

Brief article description	Feed-through header
---------------------------	---------------------

# Printed-circuit board connector - DMCV 1,5/ 4-G1F-3,5-LR P20THR - 1787412

## Technical data

### Item properties

Plug-in system	MINI COMBICON - DFMC 1,5
Type of contact	Male connector
Range of articles	DMCV 1,5/...-G1F-THR
Pitch	3.5 mm
Number of positions	4
Mounting type	THR soldering
Pin layout	Linear pinning
Locking	Lock & release threaded flange
Number of levels	2
Number of connections	8
Number of potentials	8
Pin connector pattern alignment	Standard

### Electrical parameters

Nominal current	8 A
Nom. voltage	160 V
Rated voltage (III/3)	160 V
Rated voltage (III/2)	160 V
Rated voltage (II/2)	250 V
Rated surge voltage (III/3)	2.5 kV
Rated surge voltage (III/2)	2.5 kV
Rated surge voltage (II/2)	2.5 kV

### Material data - contact

Note	WEEE/RoHS-compliant, free of whiskers according to IEC 60068-2-82/ JEDEC JESD 201
Contact material	Cu alloy
Surface characteristics	Tin-plated
Metal surface contact area (top layer)	Tin (3 - 5 µm Sn)
Metal surface contact area (middle layer)	Nickel (1.3 - 3 µm Ni)
Metal surface soldering area (top layer)	Tin (3 - 5 µm Sn)
Metal surface soldering area (middle layer)	Nickel (1.3 - 3 µm Ni)

### Material data - housing

Housing color	black (9005)
Insulating material	LCP
Insulating material group	IIIa
CTI according to IEC 60112	175

# Printed-circuit board connector - DMCV 1,5/ 4-G1F-3,5-LR P20THR - 1787412

## Technical data

### Material data - housing

Flammability rating according to UL 94	V0
--	----

### Dimensions for the product

Caption	Schematische Abbildung - weitere Details siehe Produktfamilienzeichnung im Download Center
Length [ l ]	10.6 mm
Width [ w ]	21 mm
Height [ h ]	12 mm
Pitch	3.5 mm
Height (without solder pin)	10 mm
Solder pin [P]	2 mm
Pin spacing	5.50 mm
Pin dimensions	0.8 x 0.8 mm

### Dimensions for PCB design

Hole diameter	1.4 mm
Pin spacing	5.50 mm

### Packaging information

Type of packaging	packed in cardboard
Pieces per package	50
Denomination packing units	Pcs.

### Ambient conditions

Ambient temperature (storage/transport)	-40 °C ... 70 °C
Ambient temperature (assembly)	-5 °C ... 100 °C
Ambient temperature (operation)	-40 °C ... 100 °C (dependent on the derating curve)

### Air clearances and creepage distances

Clearances and creepage distances	IEC 60664-1:2007-04
Specification	IEC 60664-1:2007-04
Minimum clearance - inhomogeneous field (III/3)	1.5 mm
Minimum clearance - inhomogeneous field (III/2)	1.5 mm
Minimum clearance - inhomogeneous field (II/2)	1.5 mm
Minimum creepage distance value (III/3)	2.5 mm
Minimum creepage distance value (III/2)	1.6 mm
Minimum creepage distance value (II/2)	2.5 mm

### Mechanical tests (A)

Test specification	IEC 61984
--------------------	-----------

# Printed-circuit board connector - DMCV 1,5/ 4-G1F-3,5-LR P20THR - 1787412

## Technical data

### Mechanical tests (A)

Insertion strength per pos. approx.	3 N
Withdraw strength per pos. approx.	2 N
Polarization when inserted requirement >20 N	Test passed
Contact holder in insert requirements >20 N	Test passed

### Durability tests (B)

Specification	IEC 60512-9-1:2010-03
Contact resistance R <sub>1</sub>	2.1 mΩ
Insertion/withdrawal cycles	25
Contact resistance R <sub>2</sub>	2.4 mΩ
Impulse withstand voltage at sea level	2.95 kV

### Thermal tests (C)

Specification	IEC 60512-5-1:2002-02
Number of positions	20
Upper limiting temperature requirements <100 °C	Test passed

### Climatic tests (D)

Specification	ISO 6988:1985-02
Cold stress	-40 °C/2 h
Thermal stress	100 °C/168 h
Corrosive stress	0.2 dm <sup>3</sup> SO <sub>2</sub> on 300 dm <sup>3</sup> /40 °C/1 cycle
Impulse withstand voltage at sea level	2.95 kV
Power-frequency withstand voltage	1.39 kV

### Environmental and durability tests (E)

Specification	IEC 61984:2008-10
Result, degree of protection, IP code	Finger safety with IP20 test finger

### Vibration test

Specification	IEC 60068-2-6:2007-12
Frequency	10 - 150 - 10 Hz
Sweep speed	1 octave/min
Amplitude	0.35 mm (10 - 60.1 Hz)
Acceleration	5 g (60.1 - 150 Hz)
Test duration per axis	2.5 h

### Standards and Regulations

Connection in acc. with standard	EN-VDE
----------------------------------	--------

# Printed-circuit board connector - DMCV 1,5/ 4-G1F-3,5-LR P20THR - 1787412

## Technical data

### Standards and Regulations

	CUL
Flammability rating according to UL 94	V0

### Environmental Product Compliance

China RoHS	Environmentally friendly use period: unlimited = EFUP-e
	No hazardous substances above threshold values

## Drawings

Diagram

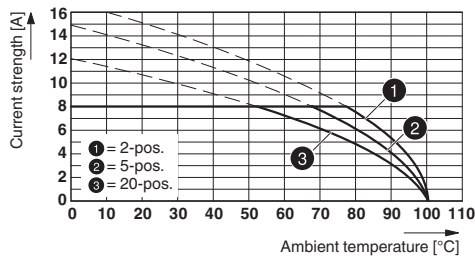

Schematic diagram

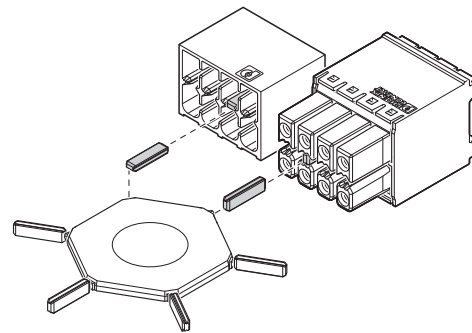

Type: DFMC 1,5/...-STF-3,5 with DMCV 1,5/...-G1F-3,5-LR P...THR

Use of the CP-DMC... coding profile

Drilling diagram

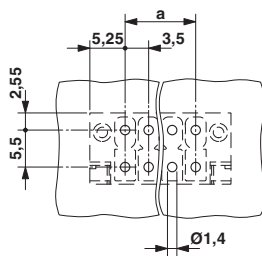

Dimensional drawing

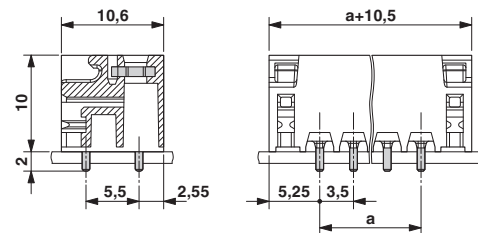

# Printed-circuit board connector - DMCV 1,5/ 4-G1F-3,5-LR P20THR - 1787412

Schematic diagram

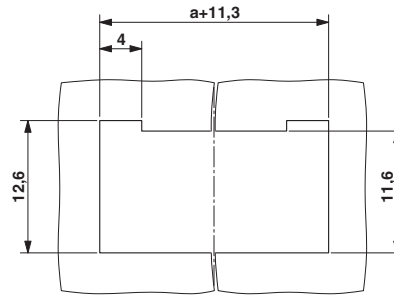

Panel cutout

## Classifications

eCl@ss

eCl@ss 10.0.1	27440402
eCl@ss 11.0	27460201
eCl@ss 4.0	27260700
eCl@ss 4.1	27260700
eCl@ss 5.0	27260700
eCl@ss 5.1	27260700
eCl@ss 6.0	27260700
eCl@ss 7.0	27440402
eCl@ss 9.0	27440402

ETIM

ETIM 4.0	EC002637
ETIM 6.0	EC002637
ETIM 7.0	EC002637

UNSPSC

UNSPSC 6.01	30211810
UNSPSC 7.0901	39121409
UNSPSC 11	39121409
UNSPSC 12.01	39121409
UNSPSC 13.2	39121409
UNSPSC 18.0	39121409
UNSPSC 19.0	39121409
UNSPSC 20.0	39121409
UNSPSC 21.0	39121409

# Printed-circuit board connector - DMCV 1,5/ 4-G1F-3,5-LR P20THR - 1787412

## Approvals

### Approvals

#### Approvals

VDE Gutachten mit Fertigungsüberwachung / IECEE CB Scheme / EAC / cULus Recognized

#### Ex Approvals

### Approval details

VDE Gutachten mit Fertigungsüberwachung		<a href="http://www2.vde.com/de/Institut/Online-Service/VDE-gepruefteProdukte/Seiten/Online-Suche.aspx">http://www2.vde.com/de/Institut/Online-Service/ VDE-gepruefteProdukte/Seiten/Online-Suche.aspx</a>	40038423
Nominal voltage UN		160 V	
Nominal current IN		8 A	

IECEE CB Scheme		<a href="http://www.iecee.org/">http://www.iecee.org/</a>	DE1-60359_B1_B2
Nominal voltage UN		160 V	
Nominal current IN		8 A	

EAC			B.01687
-----	---	--	---------

cULus Recognized		<a href="http://database.ul.com/cgi-bin/XYV/template/LISEXT/1FRAME/index.htm">http://database.ul.com/cgi-bin/XYV/template/LISEXT/1FRAME/index.htm</a>	E60425-20110128
	B	C	D
Nominal voltage UN	300 V	50 V	300 V
Nominal current IN	8 A	8 A	8 A

## Printed-circuit board connector - DMCV 1,5/ 4-G1F-3,5-LR P20THR - 1787412

### Accessories

Accessories

Coding element

Coding profile - CP-DMC 1,5 NAT - 1790647

Coding profile, for insertion between the coding ribs of the connector and the header following the reflow soldering process, insulating material, color: natural



---

### Additional products

Printed-circuit board connector - DFMC 1,5/ 4-STF-3,5 - 1790315



Plug, nominal current: 8 A, rated voltage (III/2): 160 V, number of positions: 4 with 8 contacts, pitch: 3.5 mm, connection method: spring-cage connection, color: green, contact surface: tin

Printed-circuit board connector - DFMC 1,5/ 4-ST-3,5-LR - 1790506



Plug, nominal current: 8 A, rated voltage (III/2): 160 V, number of positions: 4 with 8 contacts, pitch: 3.5 mm, connection method: spring-cage connection, color: green, contact surface: tin