

Printed-circuit board connector - PC 5/ 6-ST1-7,62 - 177765

Please be informed that the data shown in this PDF Document is generated from our Online Catalog. Please find the complete data in the user's documentation. Our General Terms of Use for Downloads are valid (<http://phoenixcontact.com/download>)



PCB connector, nominal current: 41 A, rated voltage (III/2): 1000 V, nominal cross section: 6 mm², number of positions: 6, pitch: 7.62 mm, connection method: Screw connection with tension sleeve, color: green, contact surface: Tin

The figure shows a 5-pos. version of the product

Your advantages

- ✓ Well-known connection principle allows worldwide use
- ✓ Low temperature rise, thanks to maximum contact force
- ✓ Allows connection of two conductors
- ✓ Integrated double steel spring provides additional safety in the event of temperature and power fluctuations
- ✓ 600 V UL approval in the smallest of dimensions



Key Commercial Data

Packing unit	1 pc
Minimum order quantity	50 pc
GTIN	 4 046356 522908
GTIN	4046356522908
Weight per Piece (excluding packing)	26.800 g
Custom tariff number	85366990
Country of origin	Germany

Technical data

Item properties

Brief article description	Printed-circuit board connector
Plug-in system	POWER COMBICON 5

Printed-circuit board connector - PC 5/ 6-ST1-7,62 - 1777765

Technical data

Item properties

Type of contact	Female connector
Range of articles	PC 5/..-ST1
Pitch	7.62 mm
Number of positions	6
Connection method	Screw connection with tension sleeve
Drive form screw head	Slotted (L)
Screw thread	M3
Locking	without
Number of levels	1
Number of connections	6
Number of potentials	6

Electrical parameters

Nominal current	41 A
Nom. voltage	1000 V
Rated voltage	1000 V
Rated voltage (III/2)	1000 V
Rated voltage (II/2)	1000 V
Rated surge voltage (III/3)	8 kV
Rated surge voltage (III/2)	8 kV
Rated surge voltage (II/2)	6 kV

Connection capacity

Connection method	Screw connection with tension sleeve
pluggable	Yes
Conductor cross section solid	0.2 mm ² ... 10 mm ²
Conductor cross section flexible	0.2 mm ² ... 6 mm ²
Conductor cross section AWG / kcmil	24 ... 10
Conductor cross section flexible, with ferrule without plastic sleeve	0.25 mm ² ... 6 mm ²
Conductor cross section, flexible, with ferrule, with plastic sleeve	0.25 mm ² ... 4 mm ²
2 conductors with same cross section, solid	0.2 mm ² ... 2.5 mm ²
2 conductors with same cross section, flexible	0.2 mm ² ... 4 mm ²
2 conductors with same cross section, flexible, with ferrule without plastic sleeve	0.25 mm ² ... 1.5 mm ²
2 conductors with the same cross section, flexible, with TWIN ferrule with plastic sleeve	0.25 mm ² ... 2.5 mm ²
Cylindrical gauge a x b / diameter	3.6 mm x 3.1 mm / 3.4 mm
Stripping length	10 mm

Printed-circuit board connector - PC 5/ 6-ST1-7,62 - 1777765

Technical data

Connection capacity

Torque	0.5 Nm ... 0.8 Nm ($\leq 4 \text{ mm}^2$ is 0.5 Nm to 0.6 Nm, $> 4 \text{ mm}^2$ is 0.7 Nm to 0.8 Nm)
--------	--

Material data - contact

Note	WEEE/RoHS-compliant, free of whiskers according to IEC 60068-2-82/ JEDEC JESD 201
Contact material	Cu alloy
Surface characteristics	hot-dip tin-plated
Metal surface terminal point (top layer)	Tin (4 - 8 μm Sn)
Metal surface contact area (top layer)	Tin (4 - 8 μm Sn)

Material data - housing

Housing color	green (6021)
Insulating material	PA
Insulating material group	I
CTI according to IEC 60112	600
Flammability rating according to UL 94	V0
Glow wire flammability index GWFI according to EN 60695-2-12	850
Glow wire ignition temperature GWIT according to EN 60695-2-13	775
Temperature for the ball pressure test according to EN 60695-10-2	125 °C

Dimensions for the product

Caption	Schematische Abbildung - weitere Details siehe Produktfamilienzeichnung im Download Center
Length [l]	35.25 mm
Width [w]	45.67 mm
Height [h]	19.7 mm
Pitch	7.62 mm
Height (without solder pin)	19.7 mm

Packaging information

Type of packaging	packed in cardboard
Pieces per package	50
Denomination packing units	Pcs.

Ambient conditions

Ambient temperature (storage/transport)	-40 °C ... 70 °C
Ambient temperature (assembly)	-5 °C ... 100 °C
Ambient temperature (operation)	-40 °C ... 100 °C (dependent on the derating curve)

Termination and connection method

Test for conductor damage and slackening	IEC 60999-1:1999-11
--	---------------------

Printed-circuit board connector - PC 5/ 6-ST1-7,62 - 1777765

Technical data

Termination and connection method

	Test passed
--	-------------

Pull-out test

Pull-out test	IEC 60999-1:1999-11
	Test passed
Conductor cross section / conductor type / tensile force	0.2 mm ² / solid / > 10 N
	0.2 mm ² / flexible / > 10 N
	6 mm ² / solid / > 80 N
	4 mm ² / flexible / > 60 N
	6 mm ² / flexible / > 80 N
	10 mm ² / solid / > 90 N

Mechanical tests according to standard

Test specification	IEC 61984
Visual inspection	IEC 60512-1-1:2002-02
Dimension check	IEC 60512-1-2:2002-02
Resistance of inscriptions	IEC 60068-2-70:1995-12
Insertion and withdrawal force	IEC 60512-13-2:2006-02
No. of cycles	50
Insertion strength per pos. approx.	8 N
Withdraw strength per pos. approx.	4 N
Polarization and coding	IEC 60512-13-5:2006-02
Contact holder in insert	IEC 60512-15-1:2008-05
Test force per pos.	29 N

Air clearances and creepage distances

Clearances and creepage distances	IEC 60664-1:2007-04
Specification	IEC 60664-1:2007-04
Minimum clearance - inhomogeneous field (III/3)	8 mm
Minimum clearance - inhomogeneous field (III/2)	8 mm
Minimum clearance - inhomogeneous field (II/2)	5.5 mm
Minimum creepage distance value (III/3)	12.5 mm
Minimum creepage distance value (III/2)	5 mm
Minimum creepage distance value (II/2)	5 mm

Current carrying capacity / derating curves

Caption	Type: PC 5/...-ST(F)1-7,62 with PC 5/...-G(F)U-7,62 Conductor cross section: 10 mm ²
Specification	IEC 61984:2008-10
Reduction factor	0.8

Printed-circuit board connector - PC 5/ 6-ST1-7,62 - 177765

Technical data

Current carrying capacity / derating curves

Note	Representation based on IEC 60512-5-2:2002-02
	For number of positions, see diagram

Mechanical tests (A)

Test specification	IEC 61984
Insertion strength per pos. approx.	8 N
Withdraw strength per pos. approx.	4 N
Polarization when inserted requirement >20 N	Test passed
Contact holder in insert requirements >20 N	Test passed

Durability tests (B)

Specification	IEC 60512-9-1:2010-03
Contact resistance R ₁	0.4 mΩ
Insertion/withdrawal cycles	50
Contact resistance R ₂	0.4 mΩ
Impulse withstand voltage at sea level	7.3 kV
Power-frequency withstand voltage	3.31 kV
Insulation resistance, neighboring positions	> 34 TΩ

Thermal tests (C)

Specification	IEC 60512-5-1:2002-02
Number of positions	12
Conductor cross section	10 mm ²
Test current	41 A DC
Upper limiting temperature requirements <100 °C	Test passed

Climatic tests (D)

Specification	ISO 6988:1985-02
Cold stress	-40 °C/2 h
Thermal stress	100 °C/168 h
Corrosive stress	0.2 dm ³ SO ₂ on 300 dm ³ /40 °C/1 cycle
Impulse withstand voltage at sea level	7.3 kV
Power-frequency withstand voltage	3.31 kV

Environmental and durability tests (E)

Specification	IEC 61984:2008-10
Result, degree of protection, IP code	Back of hand safety with IP10 access probe

Environmental Product Compliance

REACH SVHC	Lead 7439-92-1
------------	----------------

Printed-circuit board connector - PC 5/ 6-ST1-7,62 - 177765

Technical data

Environmental Product Compliance

China RoHS	Environmentally Friendly Use Period = 50 years
	For details about hazardous substances go to tab "Downloads", Category "Manufacturer's declaration"

Drawings

Diagram

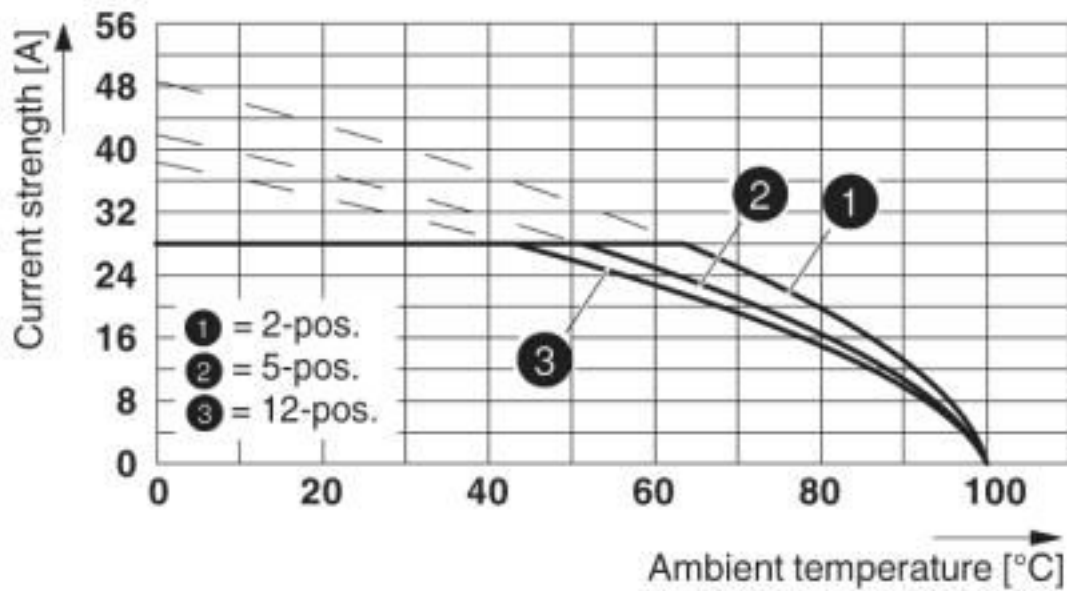

Derating curve for: PC 5/...-ST1-7,62 with PC 4/...-G-7,62
Conductor cross section: 4 mm²

Printed-circuit board connector - PC 5/ 6-ST1-7,62 - 177765

Diagram

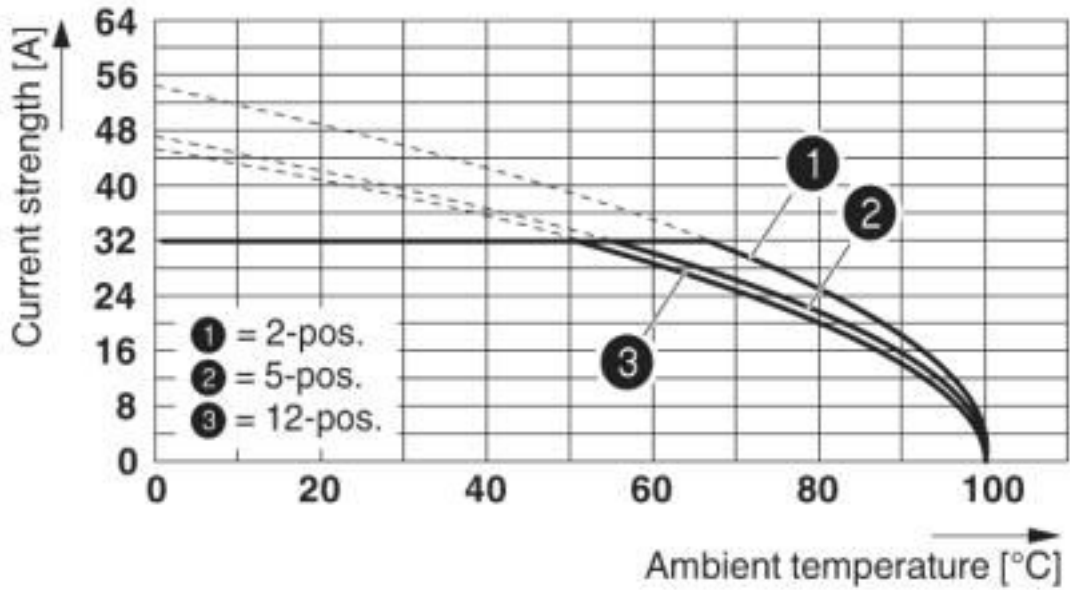

Derating curve for: PC 5/...-ST1-7,62 with PC 5/...-G-7,62
Conductor cross section: 6 mm²

Diagram

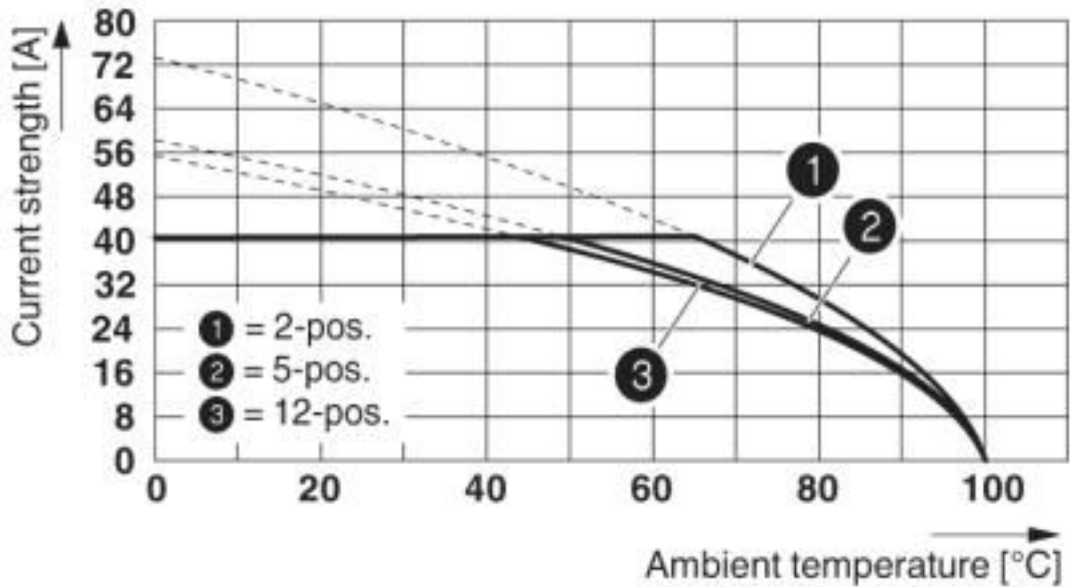

Derating curve for: PC 5/...-ST1-7,62 with PC 5/...-G-7,62
Conductor cross section: 10 mm²

Printed-circuit board connector - PC 5/ 6-ST1-7,62 - 177765

Diagram

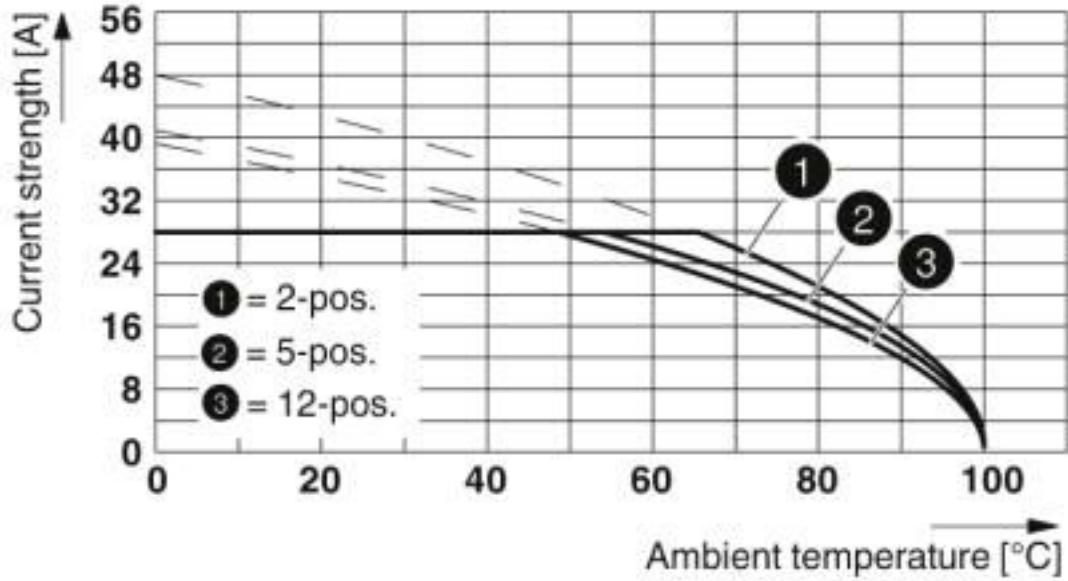

Derating curve for: PC 5/...-ST1-7,62 with PCV 4/...-G-7,62
Conductor cross section: 4 mm²

Diagram

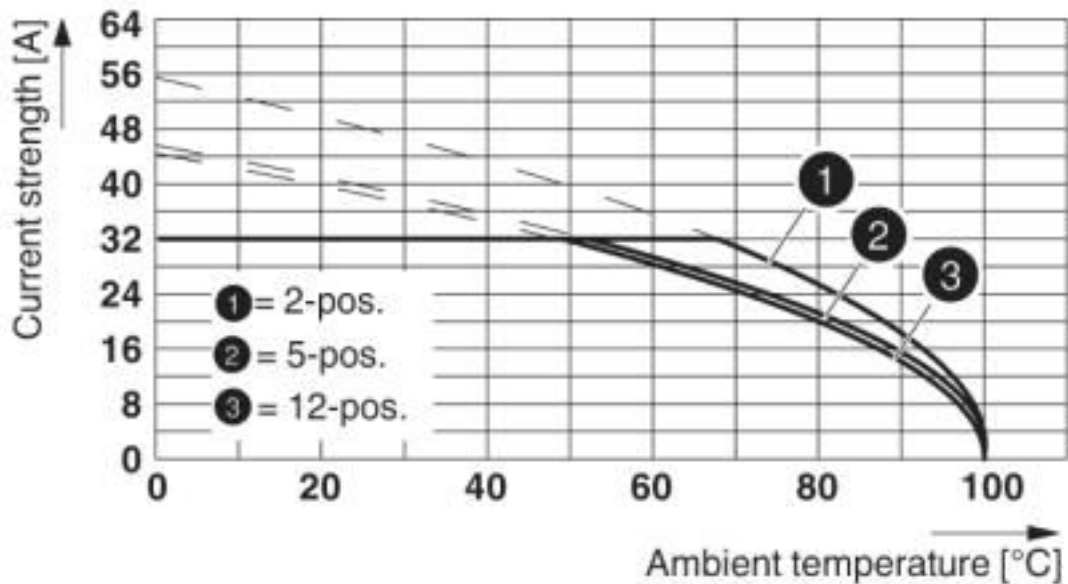

Derating curve for: PC 5/...-ST1-7,62 with PCV 4/...-G-7,62
Conductor cross section: 6 mm²

Printed-circuit board connector - PC 5/ 6-ST1-7,62 - 177765

Diagram

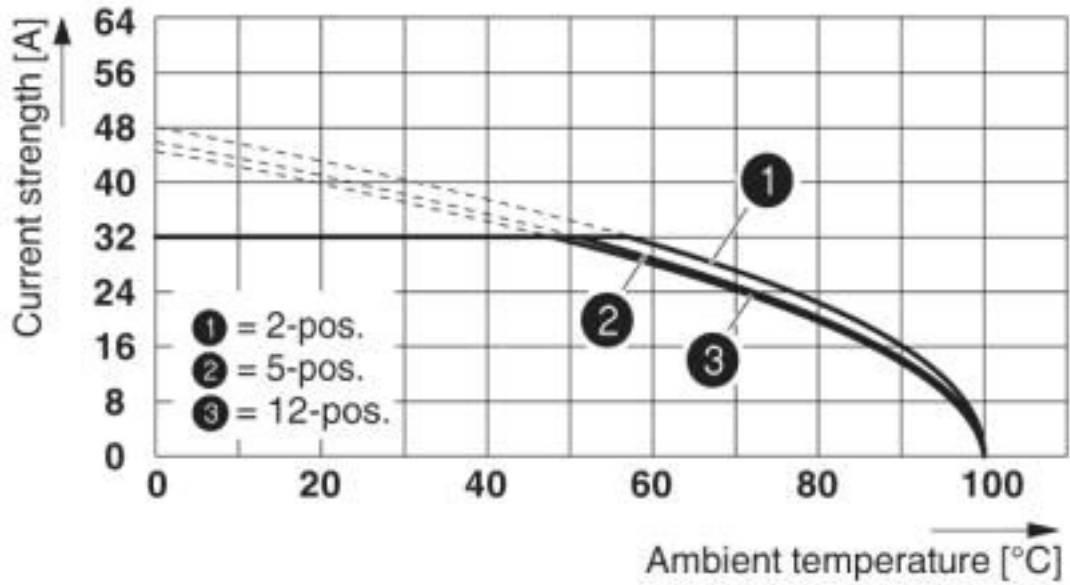

Derating curve for: PC 5/...-ST1-7,62 with PCV 5/...-G-7,62
Conductor cross section: 6 mm²

Diagram

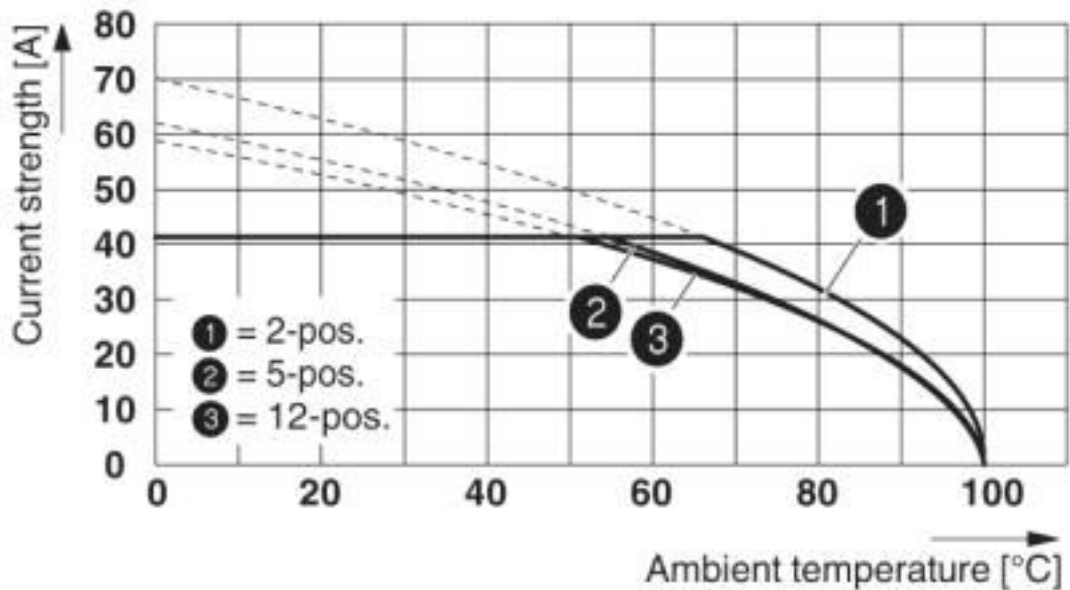

Derating curve for: PC 5/...-ST1-7,62 with PCV 5/...-G-7,62
Conductor cross section: 10 mm²

Printed-circuit board connector - PC 5/ 6-ST1-7,62 - 177765

Diagram

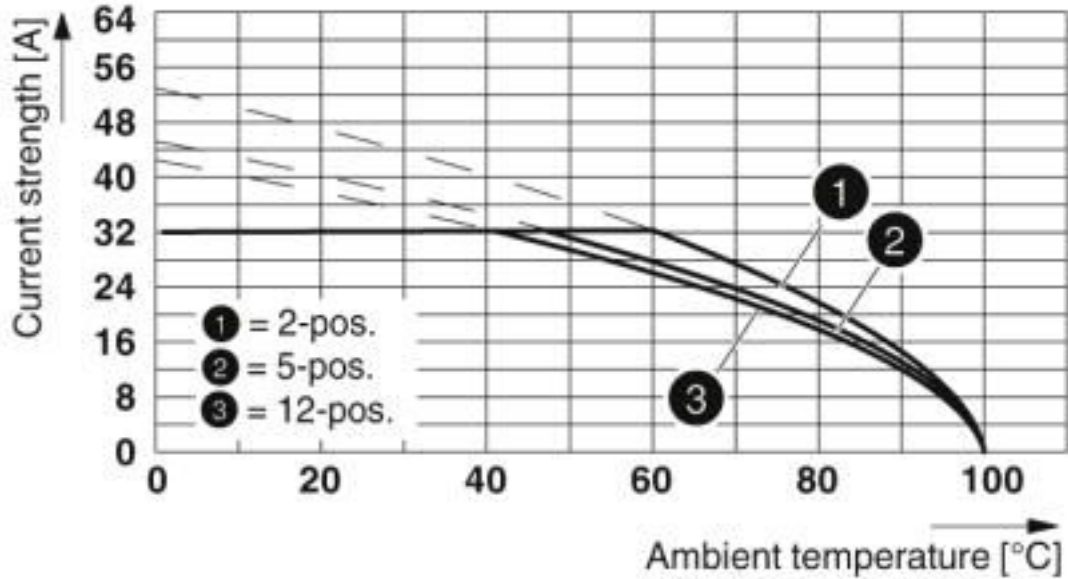

Derating curve for: PC 5/...-ST1-7,62 with PC 4/...-G-7,62
Conductor cross section: 6 mm²

Diagram

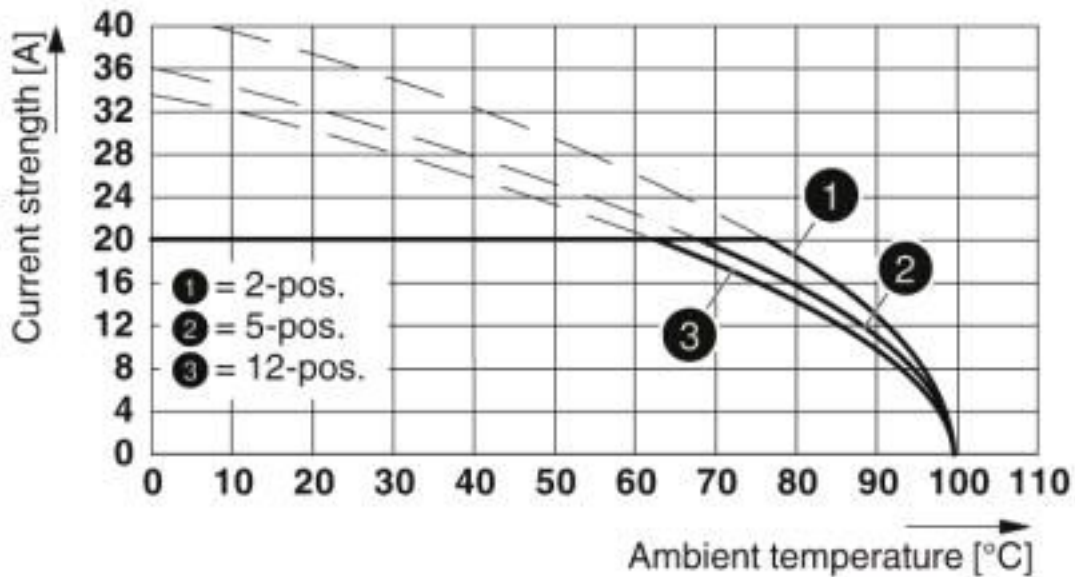

Type: PC 5/...-ST1-7,62 with PCVK 4-7,62

Printed-circuit board connector - PC 5/ 6-ST1-7,62 - 177765

Diagram

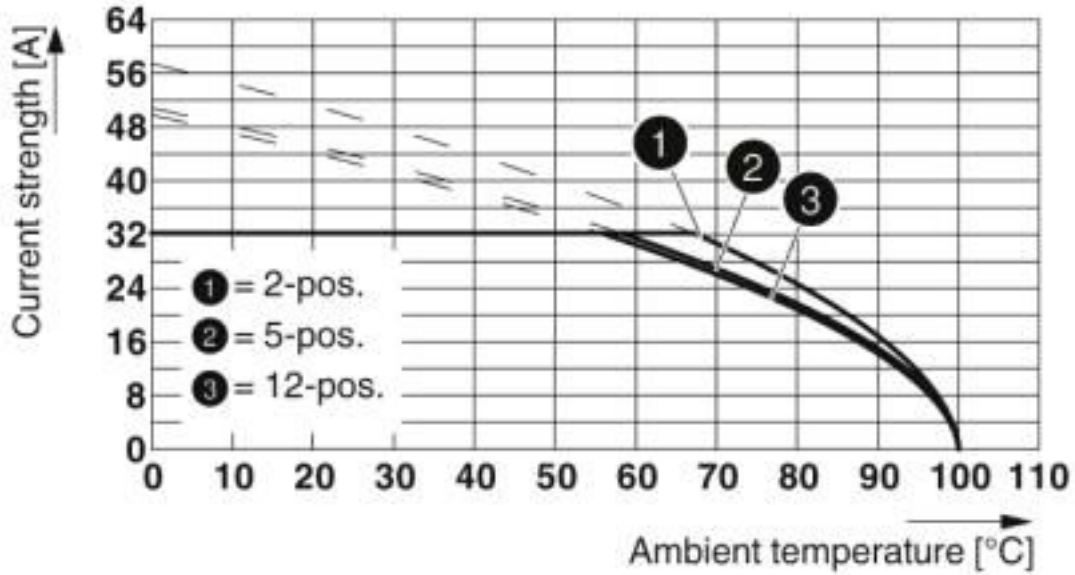

Type: PC 5/...-ST(F)1-7,62 with PC 5/...-GU(F)-7,62
Conductor cross section: 6 mm²

Diagram

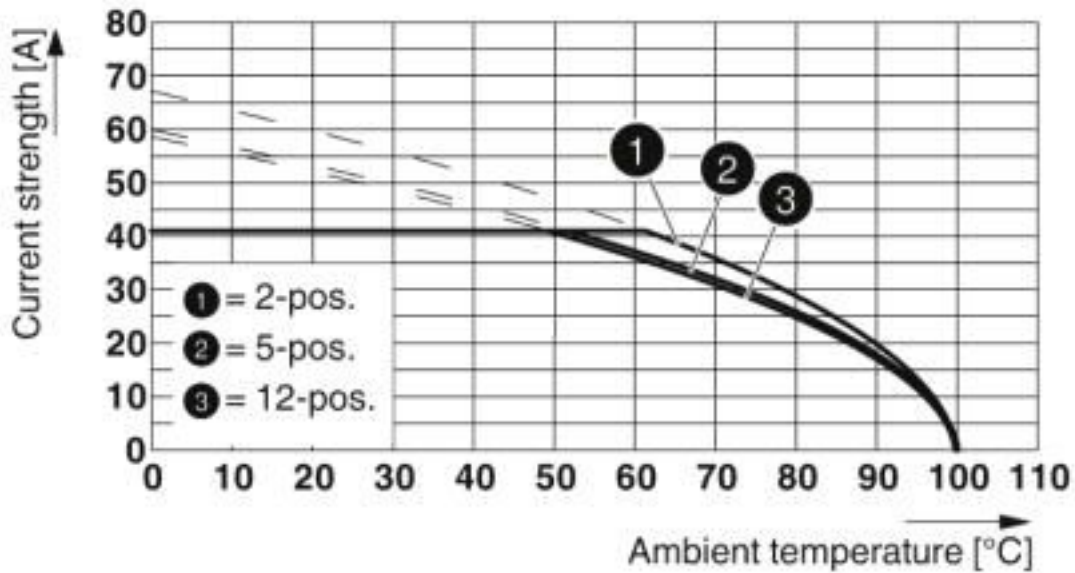

Type: PC 5/...-ST(F)1-7,62 with PC 5/...-G(F)U-7,62
Conductor cross section: 10 mm²

Printed-circuit board connector - PC 5/ 6-ST1-7,62 - 1777765

Dimensional drawing

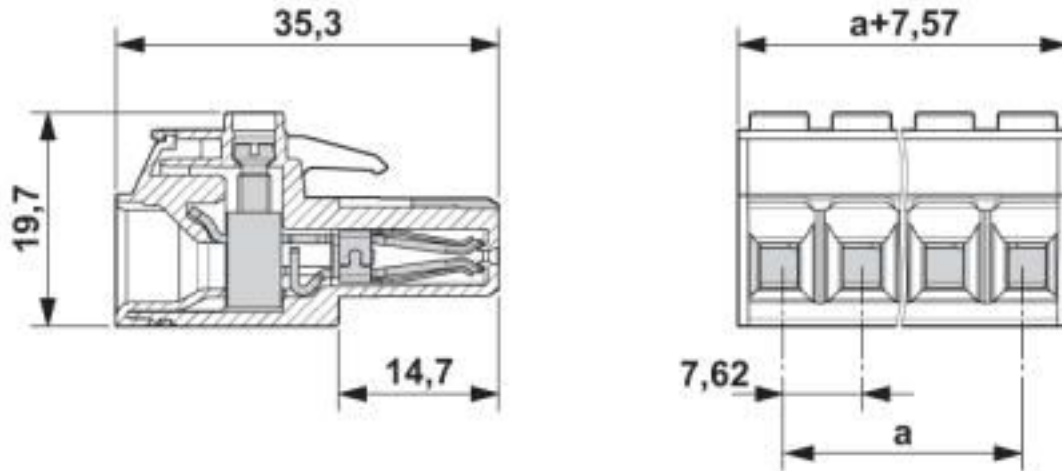

Printed-circuit board connector - PC 5/ 6-ST1-7,62 - 177765

Dimensional drawing

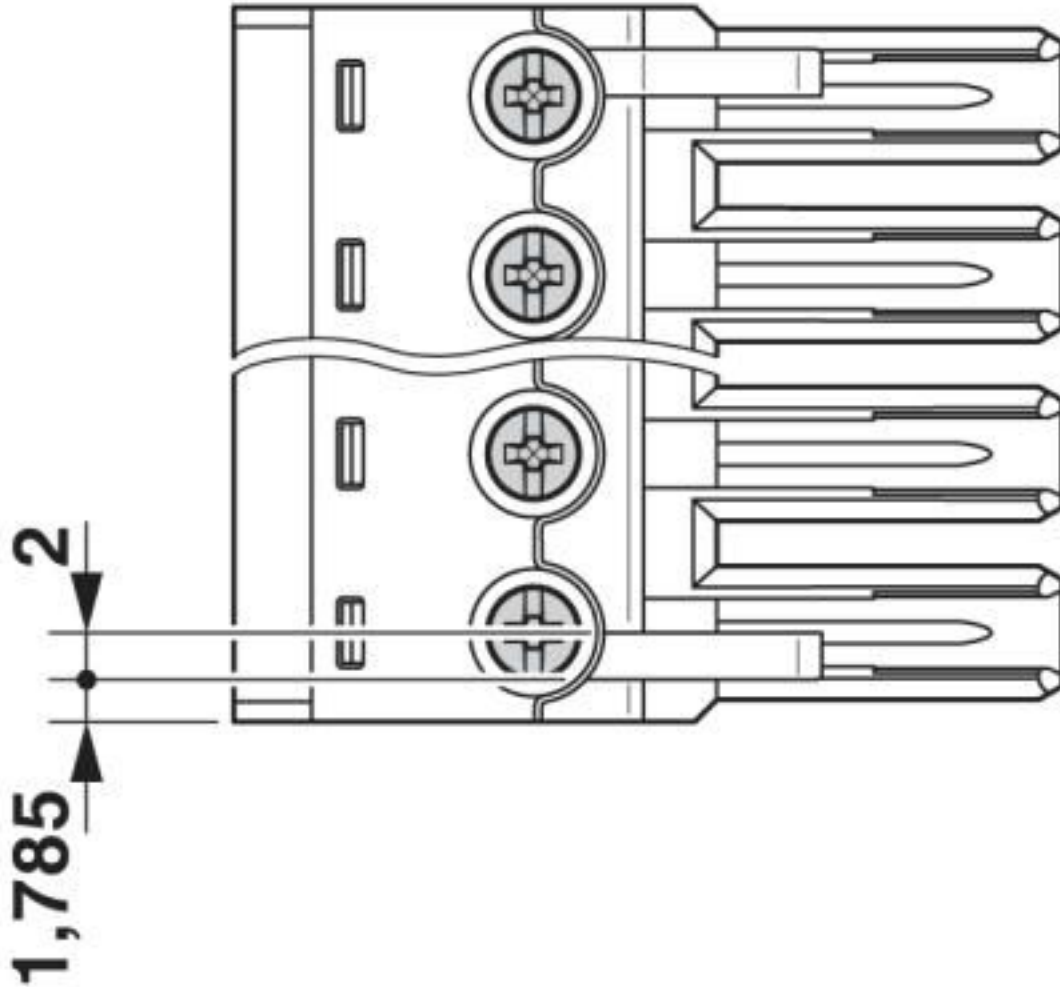

Classifications

eCl@ss

eCl@ss 10.0.1	27440309
eCl@ss 4.0	27260700
eCl@ss 4.1	27260700
eCl@ss 5.0	27260700
eCl@ss 5.1	27260700
eCl@ss 6.0	27260700
eCl@ss 7.0	27440309
eCl@ss 8.0	27440309
eCl@ss 9.0	27440309

Printed-circuit board connector - PC 5/ 6-ST1-7,62 - 1777765

Classifications

ETIM

ETIM 3.0	EC001121
ETIM 4.0	EC002638
ETIM 5.0	EC002638
ETIM 6.0	EC002638
ETIM 7.0	EC002638

UNSPSC

UNSPSC 6.01	30211810
UNSPSC 7.0901	39121409
UNSPSC 11	39121409
UNSPSC 12.01	39121409
UNSPSC 13.2	39121409
UNSPSC 18.0	39121409
UNSPSC 19.0	39121409
UNSPSC 20.0	39121409
UNSPSC 21.0	39121409

Approvals

Approvals

Approvals

EAC / cULus Recognized

Ex Approvals

Approval details

EAC		B.01687
-----	---	---------

Printed-circuit board connector - PC 5/ 6-ST1-7,62 - 177765

Approvals

cULus Recognized		http://database.ul.com/cgi-bin/XYV/template/LISEXT/1FRAME/index.htm	E60425-19920722
	B	C	
Nominal voltage UN	600 V	600 V	
Nominal current IN	41 A	41 A	
mm ² /AWG/kcmil	24-8	24-8	

Accessories

Accessories

Coding element

Coding profile - CP-PC RD - 1701967



Coding profile, for plugging into the coding ribs of the plug at a later date, insulating material, color: Red

Labeled terminal marker

Marker card - SK 7,62/3,8:FORTL.ZAHLEN - 0804549



Marker card, Card, white, labeled, horizontal: consecutive numbers 1 ... 10, 11 ... 20, etc. up to 91 ... 100, mounting type: adhesive, for terminal block width: 7.62 mm, lettering field size: 7.62 x 3.8 mm

Marker card - SK 3,8 REEL P7,62 WH CUS - 0825128



Marker card, Card, can be ordered: by card, white, labeled according to customer specifications, mounting type: adhesive, for terminal block width: 7.62 mm, lettering field size: continuous x 3.8#mm

Screwdriver tools

Printed-circuit board connector - PC 5/ 6-ST1-7,62 - 1777765

Accessories

Screwdriver - SZS 0,6X3,5 - 1205053



Actuation tool, for ST terminal blocks, insulated, also suitable for use as a bladed screwdriver, size: 0.6 x 3.5 x 100 mm, 2-component grip, with non-slip grip

Terminal marking

Marker card - SK U/3,8 WH:UNBEDRUCKT - 0803906



Marker card, Sheet, white, unlabeled, can be labeled with: PLOTMARK, CMS-P1-PLOTTER, Office printing systems, mounting type: adhesive, for terminal block width: 210 mm, lettering field size: 186 x 3.8 mm, Number of individual labels: 1440

Marker strip - SK 3,8 WH:REEL - 0805218



Marker strip, Roll, white, unlabeled, can be labeled with: THERMOMARK ROLL 2.0, THERMOMARK ROLL, THERMOMARK ROLL X1, THERMOMARK ROLLMASTER 300/600, THERMOMARK X1.2, mounting type: adhesive, for terminal block width: 90000 mm, lettering field size: continuous x 3.8#mm, Number of individual labels: 210000

Additional products

Printed-circuit board connector - IPC 5/ 6-ST-7,62 - 1709089



PCB connector, nominal current: 41 A, rated voltage (III/2): 1000 V, nominal cross section: 6 mm², number of positions: 6, pitch: 7.62 mm, connection method: Screw connection with tension sleeve, color: green, contact surface: Tin

Printed-circuit board connector - ISPC 5/ 6-STGCL-7,62 - 1748901



PCB connector, nominal current: 41 A, rated voltage (III/2): 1000 V, nominal cross section: 6 mm², number of positions: 6, pitch: 7.62 mm, connection method: Push-in spring connection, color: green, contact surface: Tin

Printed-circuit board connector - PC 5/ 6-ST1-7,62 - 177765

Accessories

Printed-circuit board connector - PC 5/ 6-G-7,62 - 1720505



PCB headers, nominal current: 41 A, rated voltage (III/2): 630 V, nominal cross section: 6 mm², number of positions: 6, pitch: 7.62 mm, color: green, contact surface: Tin, mounting: Wave soldering, pin layout: Linear pinning, solder pin [P]: 5 mm

Printed-circuit board connector - PC 5/ 6-GU-7,62 - 1720725



PCB headers, nominal current: 41 A, rated voltage (III/2): 630 V, nominal cross section: 6 mm², number of positions: 6, pitch: 7.62 mm, color: green, contact surface: Tin, mounting: Wave soldering, pin layout: Linear pinning, solder pin [P]: 4.2 mm

Printed-circuit board connector - PCV 5/ 6-G-7,62 - 1720615



PCB headers, nominal current: 41 A, rated voltage (III/2): 630 V, nominal cross section: 6 mm², number of positions: 6, pitch: 7.62 mm, color: green, contact surface: Tin, mounting: Wave soldering, pin layout: Linear pinning, solder pin [P]: 5 mm

Printed-circuit board connector - DFK-PC 5/ 6-G-7,62 - 1727621



Feed-through header, nominal current: 41 A, rated voltage (III/2): 630 V, nominal cross section: 6 mm², number of positions: 6, pitch: 7.62 mm, color: green, contact surface: Tin, mounting: Wave soldering, pin layout: Linear pinning, solder pin [P]: 4.9 mm

Printed-circuit board connector - DFK-PC 5/ 6-GU-7,62 - 1727841



Feed-through header, nominal current: 41 A, rated voltage (III/2): 630 V, nominal cross section: 6 mm², number of positions: 6, pitch: 7.62 mm, color: green, contact surface: Tin, mounting: Wave soldering, pin layout: Linear pinning, solder pin [P]: 4.26 mm

Printed-circuit board connector - PC 5/ 6-ST1-7,62 - 177765

Accessories

Printed-circuit board connector - DFK-PCV 5/ 6-G-7,62 - 1716328



Feed-through header, nominal current: 41 A, rated voltage (III/2): 630 V, nominal cross section: 6 mm², number of positions: 6, pitch: 7.62 mm, color: green, contact surface: Tin, mounting: Wave soldering, pin layout: Linear pinning, solder pin [P]: 5 mm

Feed-through plug - DFK-PC 5/ 6-ST-7,62 - 1716548



Feed-through connector, nominal current: 41 A, rated voltage (III/2): 1000 V, nominal cross section: 6 mm², number of positions: 6, pitch: 7.62 mm, connection method: Screw connection with tension sleeve, color: green, contact surface: Tin