

Connector Location A

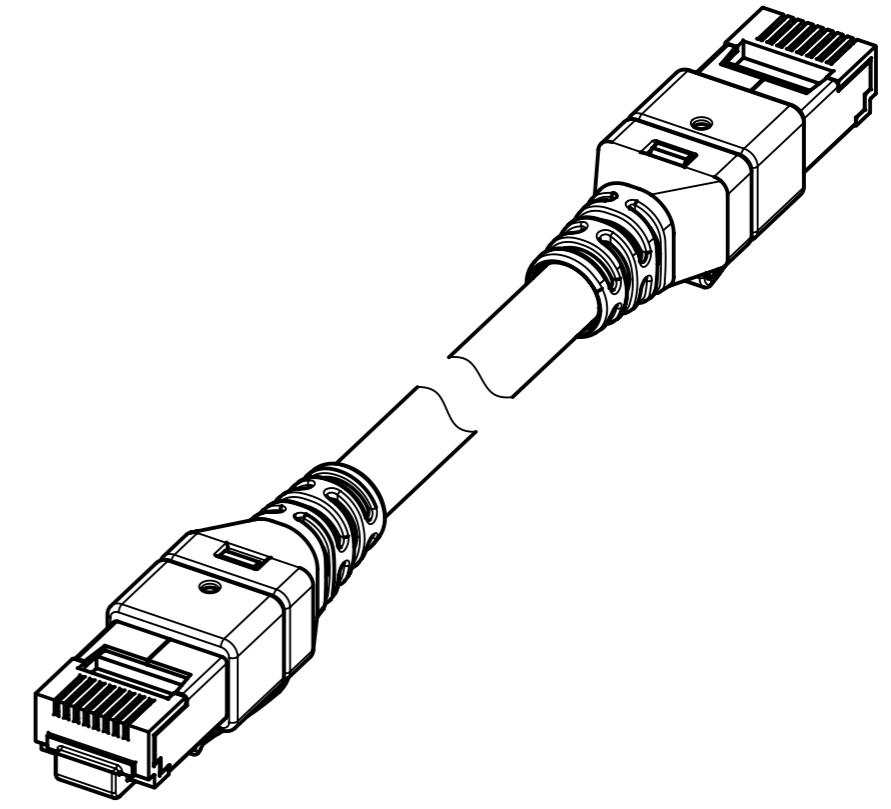

Connector Location B

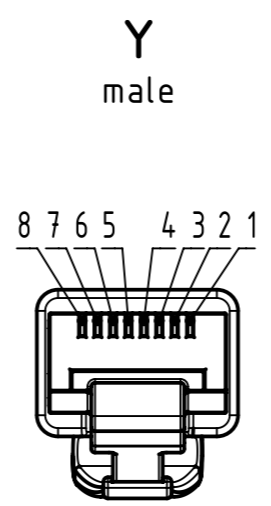
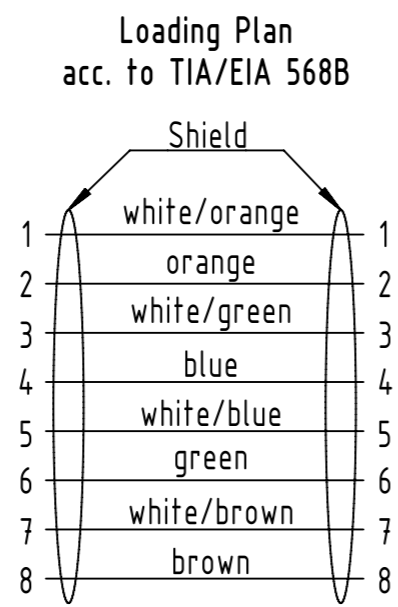
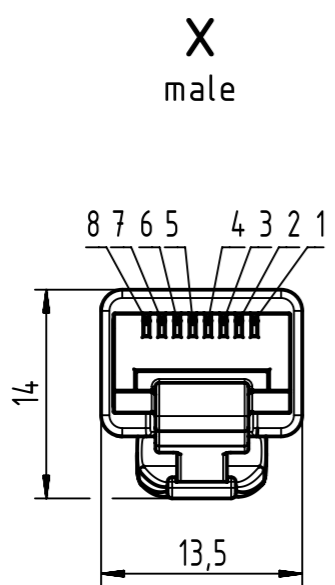
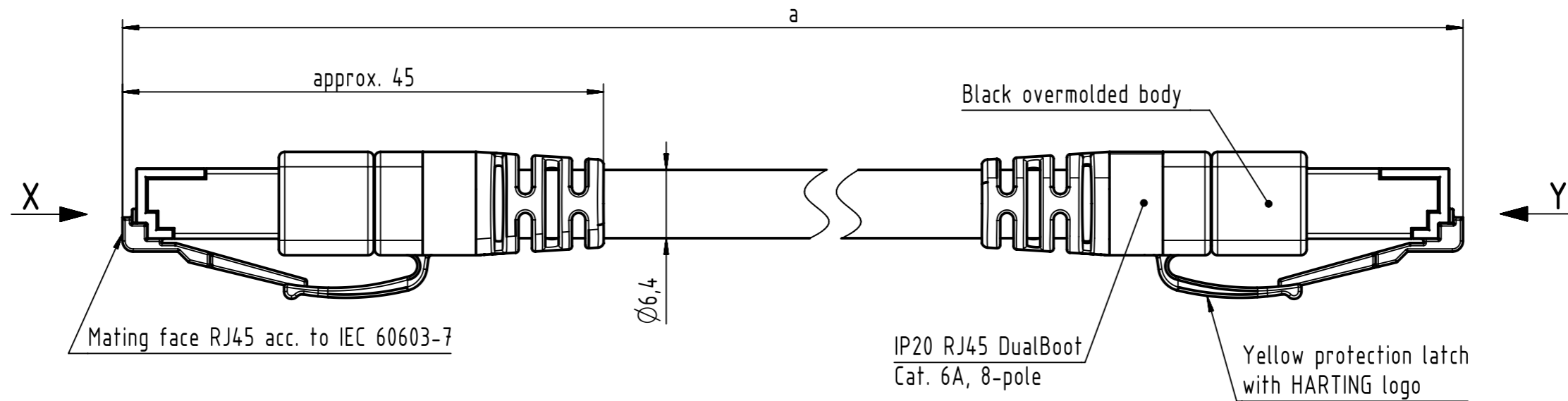

**NOTE:**  
 For lengths < 1.0m:  
 - relative positioning of the connectors to each other will be as presented in the drawing, however with an admissible angular deviation around cable axis of  $\pm 30^\circ$   
 For lengths  $\geq 1.0m$ :  
 -relative positioning of the connectors to each other not obligatory  
 \* Ethernet transmission possible for lengths up to 45m

**Temperature range:**  
 - Fixed installation:  $-30^\circ\text{C} \dots +75^\circ\text{C}$   
 - Dynamic installation:  $-5^\circ\text{C} \dots +50^\circ\text{C}$

	All rights reserved Department HCS - RO	Created by COSTEA Costea	Inspected by STOCHECIC Stochechi	Standardisation MUNTEANV Muntean	Date 2019-09-05	State Final Release	According to production drawing  Doc-Key / ECM-Nr. 100170398/UGD/012/N 500000157666  Rev. N Page 1/2
	HARTING Customised Solutions D-32339 Espelkamp	Title RJl cable 4x2xAWG26/7 CAT6A PUR		Type TB	Number 094747471XX		

1	2	3	4	5	6	7	8
4x2xAWG26/7, S/FTP, PUR, Cat.7, yellow							
45	09474747177		17	±1%			
44	09474747124		16				
43	09474747122		15				
42	09474747134		14				
41	09474747133		13.5				
40	09474747176		13				
39	09474747132		12.5				
38	09474747131		12				
37	09474747130		11.5				
36	09474747129		11				
35	09474747121		10				
34	09474747128		9.5				
33	09474747120		9				
32	09474747127		8.5				
31	09474747119		8				
30	09474747118		7.5				
29	09474747117		7				
28	09474747174		6.5				
27	09474747116		6				
26	09474747173		5.5	+0.040			
25	09474747115		5				
24	09474747172		4.75				
23	09474747171		4.5				
22	09474747170		4.25				
21	09474747114		4				
20	09474747169		3.75				
19	09474747168		3.5				
18	09474747167		3.25				
17	09474747113		3				
16	09474747140		2.75				
15	09474747112		2.5				
14	09474747139		2.25				
13	09474747111		2				
12	09474747138		1.75				
11	09474747110		1.5				
10	09474747137		1.25				
9	09474747109		1				
8	09474747108		0.9				
7	09474747107		0.8				
6	09474747106		0.7	+0.020			
5	09474747105		0.6				
4	09474747104		0.5				
3	09474747103		0.4				
2	09474747102		0.3				
1	09474747101		0.2				
Cont. no.	Part no.	Type of cable	Dim. a[m]				
4x2xAWG26/7, S/FTP, PUR, Cat.7, yellow							
59	09474747199		100*	±1%			
58	09474747184		75*				
57	09474747180		50*				
56	09474747183		45				
55	09474747175		40				
54	09474747135		35				
53	09474747136		31				
52	09474747125		30				
51	09474747182		28				
50	09474747126		25				
49	09474747181		22				
48	09474747123		20				
47	09474747179		19				
46	09474747178		18				
Cont. no.	Part no.	Type of cable	Dim. a[m]				
4x2xAWG26/7, S/FTP, PUR, Cat.7, yellow							
 All Dimensions in mm				Tech. Character.		Free size tol.	
 All rights reserved Department HCS - RO				Created by COSTEA Costea	Inspected by STOCHECIC Stochechi	Standardisation MUNTEANV Muntean	Date 2019-09-05
HARTING Customised Solutions D-32339 Espelkamp				Title RJ45 cable 4x2xAWG26/7 CAT6A PUR		Doc-Key / ECM-Nr. 100170398/UGD/012/N 500000157666	State Final Release
				Type TB	Number 094747471XX		Rev. N
						Page 2/2	