

|      |        |             |      |      |      |
|------|--------|-------------|------|------|------|
| REV. | ECN NO | DESCRIPTION | DATE | DRAW | APPR |
| A    |        | NEW         |      |      |      |

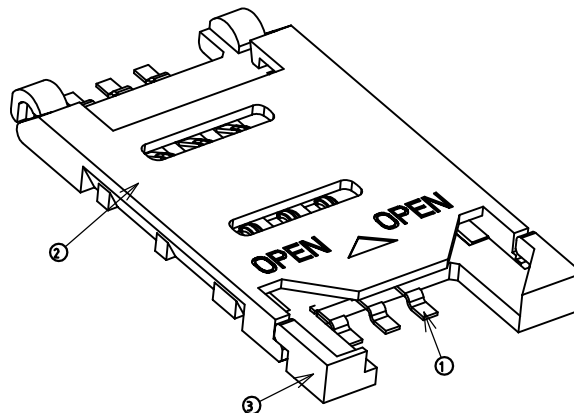
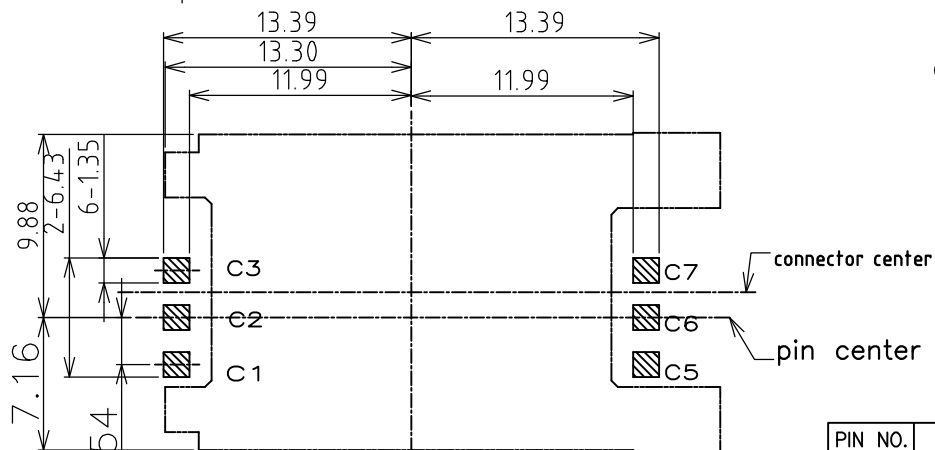
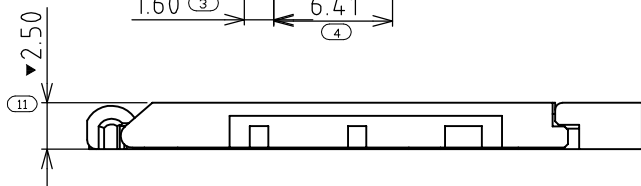
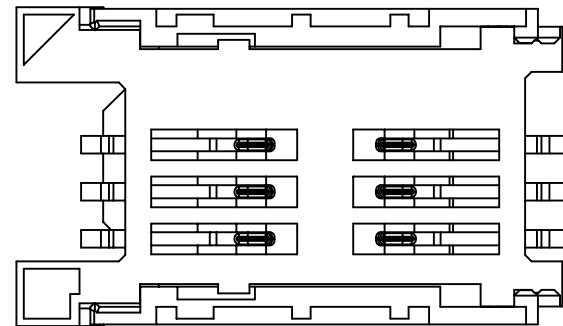
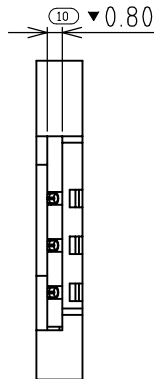
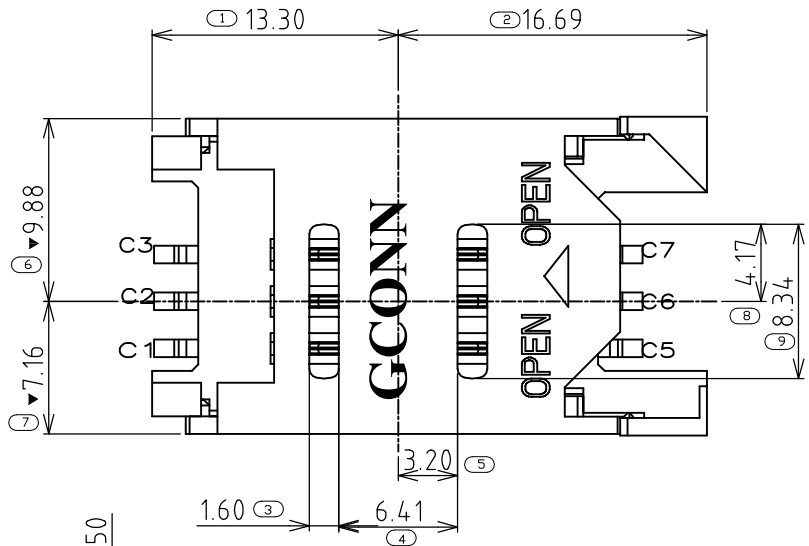

A.Material:

- 1.Insulator:High temperature thermoplastic 9T UL94V-0,(BLACK)
- 2.Pho.Bronze:Plating, 50-80U" MIN NICKEL UNDERPLATED; 1-3U" GOLD ON THE CONTACT AREA; 80U" TIN PLATING ON SOLDER TAIL

B.Electrical specifications:

- Voltage rating: 12 V AC
- Current rating: 0.5A
- Dielectric strength: 500V AC for 1 minute min
- Insulation resistance: 1000 M ohm
- Contact resistance: 50 mill.ohm max
- Operation temperature: -40°C to +105°C
- Product withstanding rff low soldering 260°C for 10s

C.Mechanical speciecations:

- 3.1 Durability: 5000 cycles

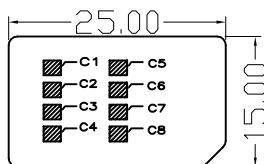

REFERENCE SIM CARD PLUG

| PIN NO. | PIN NAME                |
|---------|-------------------------|
| C1      | Supply Voltage Vcc      |
| C2      | Reset (RST)             |
| C3      | Clock(CLK)              |
| C4      | N/A                     |
| C5      | Ground                  |
| C6      | Programming Voltage Vpp |
| C7      | I/O                     |
| C8      | N/A                     |

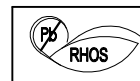

|          |                                      |                            |
|----------|--------------------------------------|----------------------------|
| Draw     | Tolerance Unless Otherwise Specified | TITLE: SIM HINGE 2.5H CONN |
| Checked  | .± 0.25 .± 3'<br>.X± 0.15 .X'± 2'    | Part No. SMNT06-D0-G250    |
| Approval | .XX± 0.10 .XX'± 1'<br>.XXX± 0.05     | Sheet: 1/1<br>Rev: A       |