

## Printed-circuit board connector - MSTBA 2,5/ 2-G-5,08 - 1757242

Please be informed that the data shown in this PDF Document is generated from our Online Catalog. Please find the complete data in the user's documentation. Our General Terms of Use for Downloads are valid (<http://phoenixcontact.com/download>)

PCB header, color: green, contact surface: Tin, type of contact: Male connector, Number of potentials: 2, Number of rows: 1, Number of positions per row: 2, number of connections: 2, product range: MSTBA 2,5/..-G, pitch: 5.08 mm, mounting: Wave soldering, pin layout: Linear pinning, solder pin [P]: 3.5 mm, plug-in system: CLASSIC COMBICON, Locking: without, type of packaging: packed in cardboard

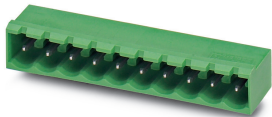

The figure shows a 10-position version of the product

### Your advantages

- ✓ Maximum flexibility when it comes to device design – one header for connectors with different connection technologies
- ✓ Well-known mounting principle allows worldwide use
- ✓ Plug-in direction parallel to the PCB
- ✓ Closed contour for optimum stability of the plug-in connection
- ✓ Easy PCB replacement thanks to plug-in modules



### Key Commercial Data

Packing unit	1 pc
Minimum order quantity	250 pc
GTIN	 4 017918 029777
GTIN	4017918029777
Weight per Piece (excluding packing)	0.960 g
Custom tariff number	85366930
Country of origin	Germany

### Technical data

#### Item properties

Brief article description	Feed-through header
Plug-in system	CLASSIC COMBICON

## Printed-circuit board connector - MSTBA 2,5/ 2-G-5,08 - 1757242

### Technical data

#### Item properties

Type of contact	Male connector
Range of articles	MSTBA 2,5/..-G
Pitch	5.08 mm
Number of positions	2
Mounting type	Wave soldering
Pin layout	Linear pinning
Locking	without
Number of levels	1
Number of connections	2
Number of potentials	2
Pin connector pattern alignment	Standard

#### Material data - housing

Housing color	green (6021)
Insulating material	PA
Insulating material group	I
CTI according to IEC 60112	600
Flammability rating according to UL 94	V0
Glow wire flammability index GWFI according to EN 60695-2-12	850
Glow wire ignition temperature GWIT according to EN 60695-2-13	775
Temperature for the ball pressure test according to EN 60695-10-2	125 °C

#### Flange specifications

Type of locking	without
Mounting flange	without

#### Dimensions for the product

Caption	Schematische Abbildung - weitere Details siehe Produktfamilienzeichnung im Download Center
Length [ l ]	12 mm
Width [ w ]	12.16 mm
Height [ h ]	12.1 mm
Pitch	5.08 mm
Height (without solder pin)	8.6 mm
Solder pin [P]	3.5 mm

#### Dimensions for PCB design

Hole diameter	1.4 mm
---------------	--------

#### Packaging information

# Printed-circuit board connector - MSTBA 2,5/ 2-G-5,08 - 1757242

## Technical data

### Packaging information

Type of packaging	packed in cardboard
Pieces per package	250
Denomination packing units	Pcs.

### General product information

Type of note	Notes on operation
Note	In accordance with IEC 61984, COMBICON connectors have no switching power (COC). During designated use, they must not be plugged in or disconnected when carrying voltage or under load.

### Air clearances and creepage distances

Clearances and creepage distances	IEC 60664-1:2007-04
Specification	IEC 60664-1:2007-04
Minimum clearance - inhomogeneous field (III/3)	3 mm
Minimum clearance - inhomogeneous field (III/2)	3 mm
Minimum clearance - inhomogeneous field (II/2)	3 mm
Minimum creepage distance value (III/3)	4 mm
Minimum creepage distance value (III/2)	3 mm
Minimum creepage distance value (II/2)	3.2 mm

### Mechanical tests (A)

Test specification	IEC 61984
Insertion strength per pos. approx.	8 N
Withdraw strength per pos. approx.	6 N
Polarization when inserted requirement >20 N	Test passed
Contact holder in insert requirements >20 N	Test passed

### Durability tests (B)

Specification	IEC 60512-9-1:2010-03
Contact resistance R <sub>1</sub>	1.4 mΩ
Insertion/withdrawal cycles	25
Contact resistance R <sub>2</sub>	1.4 mΩ
Impulse withstand voltage at sea level	4.8 kV

### Thermal tests (C)

Specification	IEC 60512-5-1:2002-02
Number of positions	24
Upper limiting temperature requirements <100 °C	Test passed

### Climatic tests (D)

Specification	ISO 6988:1985-02
---------------	------------------

# Printed-circuit board connector - MSTBA 2,5/ 2-G-5,08 - 1757242

## Technical data

### Climatic tests (D)

Cold stress	-40 °C/2 h
Thermal stress	100 °C/168 h
Corrosive stress	0.2 dm <sup>3</sup> SO <sub>2</sub> on 300 dm <sup>3</sup> /40 °C/1 cycle
Impulse withstand voltage at sea level	4.8 kV
Power-frequency withstand voltage	2.21 kV

### Environmental and durability tests (E)

Specification	IEC 61984:2008-10
Result, degree of protection, IP code	Finger safety with IP20 test finger

### Vibration test

Specification	IEC 60068-2-6:2007-12
Frequency	10 - 150 - 10 Hz
Sweep speed	1 octave/min
Amplitude	0.35 mm (10 - 60.1 Hz)
Acceleration	5 g (60.1 - 150 Hz)
Test duration per axis	2.5 h

### Standards and Regulations

Connection in acc. with standard	EN-VDE
	CSA
Flammability rating according to UL 94	V0

### Environmental Product Compliance

China RoHS	Environmentally friendly use period: unlimited = EFUP-e
	No hazardous substances above threshold values

## Drawings

Diagram

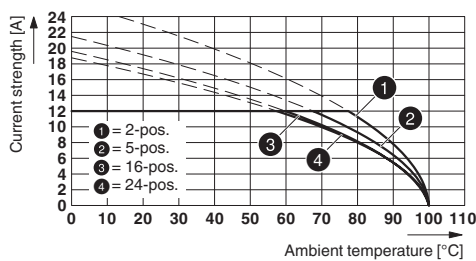

Type: FRONT-MSTB 2,5/...-ST-5,08 with MSTBA 2,5/...-G-5,08

Diagram

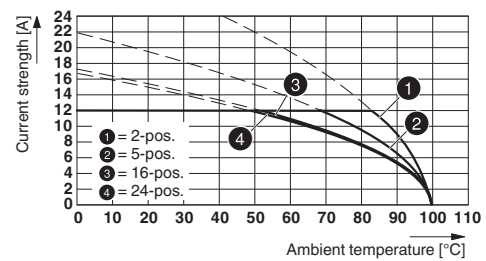

Type: IC 2,5/...-G-5,08 with MSTBA 2,5/...-G-5,08

# Printed-circuit board connector - MSTBA 2,5/ 2-G-5,08 - 1757242

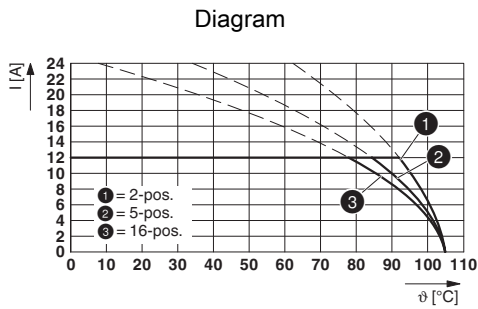

Type: FKCVR 2,5/...-ST-5,08 with MSTBA 2,5/...-G-5,08

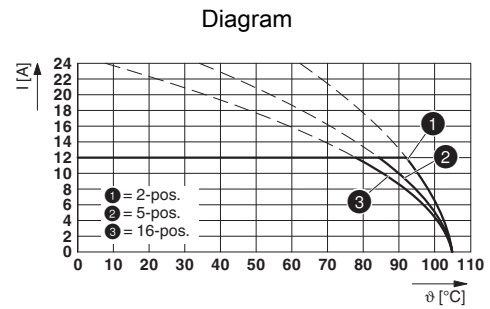

Type: FKCVW 2,5/...-ST-5,08 with MSTBA 2,5/...-G-5,08

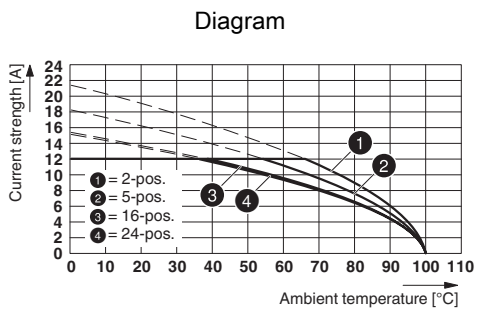

Type: MSTBP 2,5/...-ST-5,08 with MSTBW 2,5/...-G-5,08

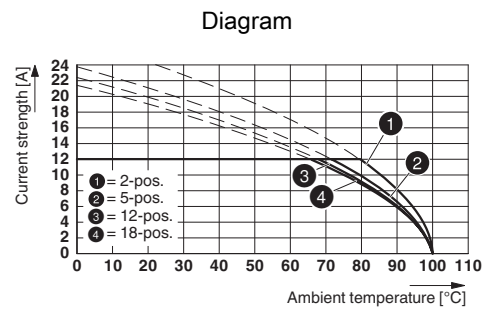

Type: MSTBT 2,5/...-ST-5,08 with MSTBA 2,5/...-G-5,08-5,08

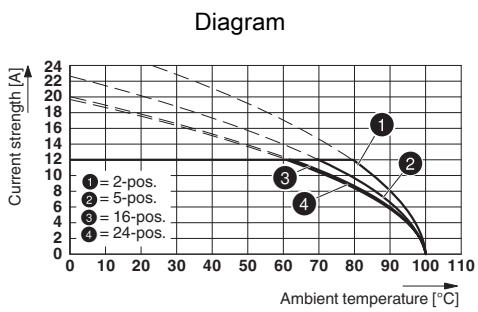

Type: MSTBP 2,5/...-ST-5,08 with MSTBA 2,5/...-G-5,08-5,08

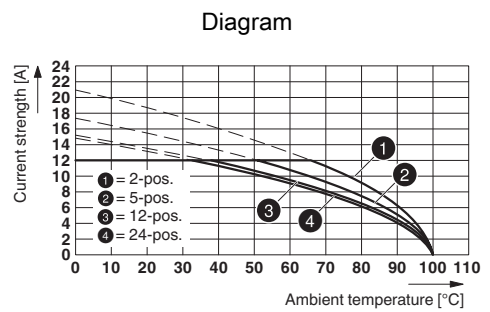

Type: MVSTBR 2,5/...-ST-5,08 with MSTBA 2,5/...-G-5,08

# Printed-circuit board connector - MSTBA 2,5/ 2-G-5,08 - 1757242

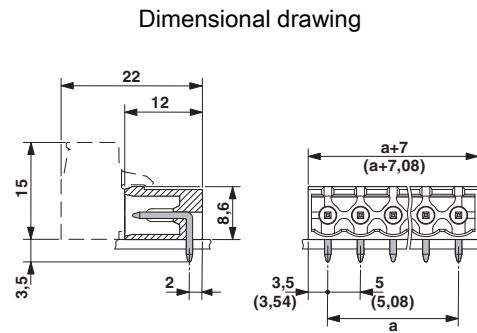
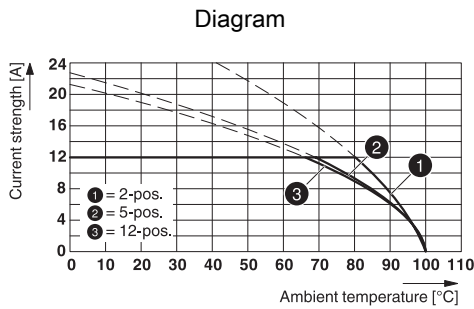

Type: FKCN 2,5/...-ST-5,08 with MSTBA 2,5/...-G-5,08

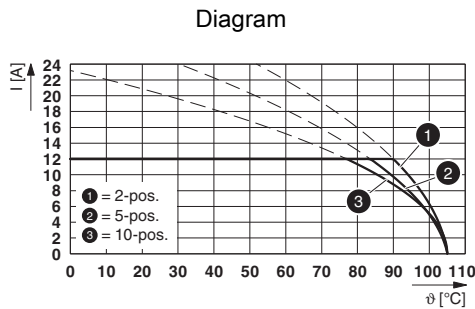

Type: TFKC 2,5/...-ST-5,08 with MSTBA 2,5/...-G-5,08

## Classifications

eCl@ss

eCl@ss 10.0.1	27440402
eCl@ss 11.0	27460201
eCl@ss 4.0	27260700
eCl@ss 4.1	27260700
eCl@ss 5.0	27260700
eCl@ss 5.1	27260700
eCl@ss 6.0	27260700
eCl@ss 7.0	27440402
eCl@ss 9.0	27440402

ETIM

ETIM 3.0	EC001121
ETIM 4.0	EC002637
ETIM 6.0	EC002637
ETIM 7.0	EC002637

# Printed-circuit board connector - MSTBA 2,5/ 2-G-5,08 - 1757242

## Classifications

### UNSPSC

UNSPSC 6.01	30211810
UNSPSC 7.0901	39121409
UNSPSC 11	39121409
UNSPSC 12.01	39121409
UNSPSC 13.2	39121409
UNSPSC 18.0	39121409
UNSPSC 19.0	39121409
UNSPSC 20.0	39121409
UNSPSC 21.0	39121409

## Approvals

### Approvals

#### Approvals

VDE Zeichengenehmigung / CSA / IECCEB Scheme / EAC / cULus Recognized

#### Ex Approvals

### Approval details

VDE Zeichengenehmigung		<a href="http://www2.vde.com/de/Institut/Online-Service/VDE-gepruefteProdukte/Seiten/Online-Suche.aspx">http://www2.vde.com/de/Institut/Online-Service/VDE-gepruefteProdukte/Seiten/Online-Suche.aspx</a>	40050648
Nominal voltage UN	250 V		
Nominal current IN	12 A		

CSA		<a href="http://www.csagroup.org/services-industries/product-listing/">http://www.csagroup.org/services-industries/product-listing/</a>	LR13631-2585950
	B	D	
Nominal voltage UN	300 V	300 V	
Nominal current IN	10 A	10 A	

# Printed-circuit board connector - MSTBA 2,5/ 2-G-5,08 - 1757242

## Approvals

IECEE CB Scheme	<b>CB</b> scheme	<a href="http://www.iecee.org/">http://www.iecee.org/</a>	DE1-60988-B1B2
Nominal voltage UN		250 V	
Nominal current IN		12 A	

EAC	<b>EAC</b>	B.01687
-----	------------	---------

cULus Recognized	<b>cULus</b>	<a href="http://database.ul.com/cgi-bin/XYV/template/LISEXT/1FRAME/index.htm">http://database.ul.com/cgi-bin/XYV/template/LISEXT/1FRAME/index.htm</a>	E60425-19931011
	B	D	
Nominal voltage UN	300 V	300 V	
Nominal current IN	15 A	10 A	

## Accessories

### Accessories

#### Coding element

Coding section - CR-MSTB - 1734401



Coding section, inserted into the recess in the header or the inverted plug, red insulating material

#### Filler plug

Accessories - MSTB-BL - 1755477



Keying cap, for forming sections, plugs onto header pin, green insulating material



## Printed-circuit board connector - MSTBA 2,5/ 2-G-5,08 - 1757242

### Accessories

#### Labeled terminal marker

Marker card - SK 5,08/3,8:FORTL.ZAHLEN - 0804293



Marker card, Card, white, labeled, horizontal: consecutive numbers 1 ... 10, 11 ... 20, etc. up to 91 ... (99)100, mounting type: adhesive, for terminal block width: 5.08 mm, lettering field size: 5.08 x 3.8 mm

---

#### Marker pen

Marker pen - B-STIFT - 1051993



Marker pen, for manual labeling of unprinted Zack strips, smear-proof and waterproof, line thickness 0.5 mm

---

#### Terminal marking

Marker card - SK 5,08/3,8:UNBEDRUCKT - 0805412



Marker card, Card, white, unlabeled, can be labeled with: Marker pen, mounting type: adhesive, for terminal block width: 5.08 mm, lettering field size: 5.08 x 3.8 mm

---

### Additional products

Printed-circuit board connector - TVMSTB 2,5/ 2-ST-5,08 - 1719008



PCB connector, nominal cross section: 2.5 mm<sup>2</sup>, color: green, nominal current: 12 A, rated voltage (III/2): 400 V, contact surface: Tin, type of contact: Female connector, Number of potentials: 2, Number of rows: 1, Number of positions per row: 2, number of connections: 4, product range: TVMSTB 2,5/-ST, pitch: 5.08 mm, connection method: Screw connection with tension sleeve, conductor/PCB connection direction: 90 °, Locking clip: - Locking clip, plug-in system: CLASSIC COMBICON, Locking: without, type of packaging: packed in cardboard

## Printed-circuit board connector - MSTBA 2,5/ 2-G-5,08 - 1757242

### Accessories

#### Printed-circuit board connector - FKCN 2,5/ 2-ST-5,08 - 1754568



PCB connector, nominal cross section: 2.5 mm<sup>2</sup>, color: green, nominal current: 12 A, rated voltage (III/2): 320 V, contact surface: Tin, type of contact: Female connector, Number of potentials: 2, Number of rows: 1, Number of positions per row: 2, number of connections: 2, product range: FKCN 2,5/..-ST, pitch: 5.08 mm, connection method: Push-in spring connection, conductor/PCB connection direction: 0 °, Locking clip: - Locking clip, plug-in system: CLASSIC COMBICON, Locking: without, type of packaging: packed in cardboard

#### Printed-circuit board connector - MSTB 2,5/ 2-ST-5,08 - 1757019



PCB connector, nominal cross section: 2.5 mm<sup>2</sup>, color: green, nominal current: 12 A, rated voltage (III/2): 320 V, contact surface: Tin, type of contact: Female connector, Number of potentials: 2, Number of rows: 1, Number of positions per row: 2, number of connections: 2, product range: MSTB 2,5/..-ST, pitch: 5.08 mm, connection method: Screw connection with tension sleeve, conductor/PCB connection direction: 0 °, Locking clip: - Locking clip, plug-in system: CLASSIC COMBICON, Locking: without, type of packaging: packed in cardboard

#### Printed-circuit board connector - MSTBP 2,5/ 2-ST-5,08 - 1769010



PCB connector, nominal cross section: 2.5 mm<sup>2</sup>, color: green, nominal current: 12 A, rated voltage (III/2): 320 V, contact surface: Tin, type of contact: Female connector, Number of potentials: 2, Number of rows: 1, Number of positions per row: 2, number of connections: 2, product range: MSTBP 2,5/..-ST, pitch: 5.08 mm, connection method: Screw connection with tension sleeve, conductor/PCB connection direction: 0 °, Locking clip: - Locking clip, plug-in system: CLASSIC COMBICON, Locking: without, type of packaging: packed in cardboard

#### Printed-circuit board connector - FRONT-MSTB 2,5/ 2-ST-5,08 - 1777280



PCB connector, nominal cross section: 2.5 mm<sup>2</sup>, color: green, nominal current: 12 A, rated voltage (III/2): 320 V, contact surface: Tin, type of contact: Female connector, Number of potentials: 2, Number of rows: 1, Number of positions per row: 2, number of connections: 2, product range: FRONT-MSTB 2,5/..-ST, pitch: 5.08 mm, connection method: Front screw connection, conductor/PCB connection direction: 0 °, Locking clip: - Locking clip, plug-in system: CLASSIC COMBICON, Locking: without, type of packaging: packed in cardboard

#### Printed-circuit board connector - MSTBT 2,5/ 2-ST-5,08 - 1779987



PCB connector, nominal cross section: 2.5 mm<sup>2</sup>, color: green, nominal current: 12 A, rated voltage (III/2): 320 V, contact surface: Tin, type of contact: Female connector, Number of potentials: 2, Number of rows: 1, Number of positions per row: 2, number of connections: 2, product range: MSTBT 2,5/..-ST, pitch: 5.08 mm, connection method: Screw connection with tension sleeve, conductor/PCB connection direction: 0 °, Locking clip: - Locking clip, plug-in system: CLASSIC COMBICON, Locking: without, type of packaging: packed in cardboard

## Printed-circuit board connector - MSTBA 2,5/ 2-G-5,08 - 1757242

### Accessories

#### Printed-circuit board connector - MVSTBR 2,5/ 2-ST-5,08 - 1792249



PCB connector, nominal cross section: 2.5 mm<sup>2</sup>, color: green, nominal current: 12 A, rated voltage (III/2): 320 V, contact surface: Tin, type of contact: Female connector, Number of potentials: 2, Number of rows: 1, Number of positions per row: 2, number of connections: 2, product range: MVSTBR 2,5/..-ST, pitch: 5.08 mm, connection method: Screw connection with tension sleeve, conductor/PCB connection direction: 90 °, Locking clip: - Locking clip, plug-in system: CLASSIC COMBICON, Locking: without, type of packaging: packed in cardboard

#### Printed-circuit board connector - MVSTBW 2,5/ 2-ST-5,08 - 1792757



PCB connector, nominal cross section: 2.5 mm<sup>2</sup>, color: green, nominal current: 12 A, rated voltage (III/2): 320 V, contact surface: Tin, type of contact: Female connector, Number of potentials: 2, Number of rows: 1, Number of positions per row: 2, number of connections: 2, product range: MVSTBW 2,5/..-ST, pitch: 5.08 mm, connection method: Screw connection with tension sleeve, conductor/PCB connection direction: -90 °, Locking clip: - Locking clip, plug-in system: CLASSIC COMBICON, Locking: without, type of packaging: packed in cardboard

#### Printed-circuit board connector - MSTBC 2,5/ 2-ST-5,08 - 1808816



PCB connector, nominal cross section: 2.5 mm<sup>2</sup>, color: green, nominal current: 12 A, rated voltage (III/2): 320 V, type of contact: Female connector, Number of potentials: 2, Number of rows: 1, Number of positions per row: 2, number of connections: 2, product range: MSTBC 2,5/..-ST, pitch: 5.08 mm, connection method: Crimp connection, conductor/PCB connection direction: 0 °, Locking clip: - Locking clip, plug-in system: CLASSIC COMBICON, Locking: without, type of packaging: packed in cardboard, Corresponding female crimp contacts with current [A] and conductor cross section range [mm<sup>2</sup>] data: 10A/MSTBC-MT 0,5-1,0 (3190564); 10A/MSTBC-MT 0,5-1,0 BA (3190645); 12A/MSTBC-MT 1,5-2,5 (3190551); 12A/MSTBC-MT 1,5-2,5 BA (3190658). BA = Bandkontakte

#### Printed-circuit board connector - MSTBC 2,5/ 2-STZ-5,08 - 1809501



PCB connector, nominal cross section: 2.5 mm<sup>2</sup>, color: green, nominal current: 12 A, rated voltage (III/2): 320 V, type of contact: Female connector, Number of potentials: 2, Number of rows: 1, Number of positions per row: 2, number of connections: 2, product range: MSTBC 2,5/..-STZ, pitch: 5.08 mm, connection method: Crimp connection, conductor/PCB connection direction: 0 °, Locking clip: - Locking clip, plug-in system: CLASSIC COMBICON, Locking: without, type of packaging: packed in cardboard, Corresponding female crimp contacts with current [A] and conductor cross section range [mm<sup>2</sup>] data: 10A/MSTBC-MT 0,5-1,0 (3190564); 10A/MSTBC-MT 0,5-1,0 BA (3190645); 12A/MSTBC-MT 1,5-2,5 (3190551); 12A/MSTBC-MT 1,5-2,5 BA (3190658). BA = Bandkontakte

#### Printed-circuit board connector - MSTBU 2,5/ 2-STD-5,08 - 1824120



Direct plug-in block, nominal cross section: 2.5 mm<sup>2</sup>, color: green, nominal current: 12 A, rated voltage (III/2): 320 V, contact surface: Tin, type of contact: Female connector, Number of potentials: 2, Number of rows: 1, Number of positions per row: 2, number of connections: 2, product range: MSTBU 2,5/..-STD, pitch: 5.08 mm, connection method: Screw connection with tension sleeve, mounting: Direct mounting, conductor/PCB connection direction: 0 °, plug-in system: CLASSIC COMBICON, Locking: without, type of packaging: packed in cardboard

## Printed-circuit board connector - MSTBA 2,5/ 2-G-5,08 - 1757242

### Accessories

---

#### Printed-circuit board connector - MSTBU 2,5/ 2-ST-5,08-FL - 1824353



Direct plug-in block, nominal cross section: 2.5 mm<sup>2</sup>, color: green, nominal current: 12 A, rated voltage (III/2): 320 V, contact surface: Tin, type of contact: Male connector, Number of potentials: 2, Number of rows: 1, Number of positions per row: 2, number of connections: 2, product range: MSTBU 2,5/..-ST -FL, pitch: 5.08 mm, connection method: Screw connection with tension sleeve, mounting: Direct mounting, conductor/PCB connection direction: 0 °, plug-in system: CLASSIC COMBICON, Locking: without, type of packaging: packed in cardboard

---

#### Printed-circuit board connector - SMSTB 2,5/ 2-ST-5,08 - 1826283



PCB connector, nominal cross section: 2.5 mm<sup>2</sup>, color: green, nominal current: 12 A, rated voltage (III/2): 320 V, contact surface: Tin, type of contact: Female connector, Number of potentials: 2, Number of rows: 1, Number of positions per row: 2, number of connections: 2, product range: SMSTB 2,5/..-ST, pitch: 5.08 mm, connection method: Screw connection with tension sleeve, conductor/PCB connection direction: -45 °, Locking clip: - Locking clip, plug-in system: CLASSIC COMBICON, Locking: without, type of packaging: packed in cardboard

---

#### Printed-circuit board connector - TMSTBP 2,5/ 2-ST-5,08 - 1853010



PCB connector, nominal cross section: 2.5 mm<sup>2</sup>, color: green, nominal current: 12 A, rated voltage (III/2): 320 V, contact surface: Tin, type of contact: Female connector, Number of potentials: 2, Number of rows: 1, Number of positions per row: 2, number of connections: 4, product range: TMSTBP 2,5/..-ST, pitch: 5.08 mm, connection method: Screw connection with tension sleeve, conductor/PCB connection direction: 0 °, Locking clip: - Locking clip, plug-in system: CLASSIC COMBICON, Locking: without, type of packaging: packed in cardboard, The plug allows conductors to be looped through from module to module.

---

#### Printed-circuit board connector - FKCVW 2,5/ 2-ST-5,08 - 1873058



PCB connector, nominal cross section: 2.5 mm<sup>2</sup>, color: green, nominal current: 12 A, rated voltage (III/2): 320 V, contact surface: Tin, type of contact: Female connector, Number of potentials: 2, Number of rows: 1, Number of positions per row: 2, number of connections: 2, product range: FKCVW 2,5/..-ST, pitch: 5.08 mm, connection method: Push-in spring connection, conductor/PCB connection direction: 0 °, Locking clip: - Locking clip, plug-in system: CLASSIC COMBICON, Locking: without, type of packaging: packed in cardboard

---

#### Printed-circuit board connector - FKCVW 2,5/ 2-ST-5,08 - 1873650



PCB connector, nominal cross section: 2.5 mm<sup>2</sup>, color: green, nominal current: 12 A, rated voltage (III/2): 320 V, contact surface: Tin, type of contact: Female connector, Number of potentials: 2, Number of rows: 1, Number of positions per row: 2, number of connections: 2, product range: FKCVW 2,5/..-ST, pitch: 5.08 mm, connection method: Push-in spring connection, conductor/PCB connection direction: -90 °, Locking clip: - Locking clip, plug-in system: CLASSIC COMBICON, Locking: without, type of packaging: packed in cardboard

---

## Printed-circuit board connector - MSTBA 2,5/ 2-G-5,08 - 1757242

### Accessories

#### Printed-circuit board connector - FKCVR 2,5/ 2-ST-5,08 - 1873951



PCB connector, nominal cross section: 2.5 mm<sup>2</sup>, color: green, nominal current: 12 A, rated voltage (III/2): 320 V, contact surface: Tin, type of contact: Female connector, Number of potentials: 2, Number of rows: 1, Number of positions per row: 2, number of connections: 2, product range: FKCVR 2,5/..-ST, pitch: 5.08 mm, connection method: Push-in spring connection, conductor/PCB connection direction: 90 °, Locking clip: - Locking clip, plug-in system: CLASSIC COMBICON, Locking: without, type of packaging: packed in cardboard

#### Printed-circuit board connector - QC 1/ 2-ST-5,08 - 1883255



PCB connector, nominal cross section: 1 mm<sup>2</sup>, color: green, nominal current: 10 A, rated voltage (III/2): 630 V, contact surface: Tin, type of contact: Female connector, Number of potentials: 2, Number of rows: 1, Number of positions per row: 2, number of connections: 2, product range: QC 1/..-ST, pitch: 5.08 mm, connection method: Displacement connection, conductor/PCB connection direction: 0 °, Locking clip: - Locking clip, plug-in system: CLASSIC COMBICON, Locking: without, type of packaging: packed in cardboard

#### Printed-circuit board connector - FKCT 2,5/ 2-ST-5,08 - 1902110



PCB connector, nominal cross section: 2.5 mm<sup>2</sup>, color: green, nominal current: 12 A, rated voltage (III/2): 320 V, contact surface: Tin, type of contact: Female connector, Number of potentials: 2, Number of rows: 1, Number of positions per row: 2, number of connections: 2, product range: FKCT 2,5/..-ST, pitch: 5.08 mm, connection method: Push-in spring connection, conductor/PCB connection direction: 0 °, Locking clip: - Locking clip, plug-in system: CLASSIC COMBICON, Locking: without, type of packaging: packed in cardboard

#### Printed-circuit board connector - TFKC 2,5/ 2-ST-5,08 - 1962600



PCB connector, nominal cross section: 2.5 mm<sup>2</sup>, color: green, nominal current: 12 A, rated voltage (III/2): 320 V, contact surface: Tin, type of contact: Female connector, Number of potentials: 2, Number of rows: 1, Number of positions per row: 2, number of connections: 4, product range: TFKC 2,5/..-ST, pitch: 5.08 mm, connection method: Push-in spring connection, conductor/PCB connection direction: 0 °, Locking clip: - Locking clip, plug-in system: CLASSIC COMBICON, Locking: without, type of packaging: packed in cardboard

#### Printed-circuit board connector - FKCS 2,5/ 2-ST-5,08 - 1975079



PCB connector, nominal cross section: 2.5 mm<sup>2</sup>, color: green, nominal current: 12 A, rated voltage (III/2): 320 V, contact surface: Tin, type of contact: Female connector, Number of potentials: 2, Number of rows: 1, Number of positions per row: 2, number of connections: 2, product range: FKCS 2,5/..-ST, pitch: 5.08 mm, connection method: Push-in spring connection, conductor/PCB connection direction: 0 °, Locking clip: - Locking clip, plug-in system: CLASSIC COMBICON, Locking: without, type of packaging: packed in cardboard

