

Printed-circuit board connector - PC 5/ 3-G-7,62 - 1720479

Please be informed that the data shown in this PDF Document is generated from our Online Catalog. Please find the complete data in the user's documentation. Our General Terms of Use for Downloads are valid (<http://phoenixcontact.com/download>)

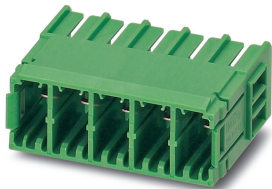

PCB header, nominal cross section: 6 mm², color: green, nominal current: 41 A, rated voltage (III/2): 630 V, contact surface: Tin, type of contact: Male connector, Number of potentials: 3, Number of rows: 1, Number of positions per row: 3, number of connections: 3, product range: PC 5/..-G, pitch: 7.62 mm, mounting: Wave soldering, pin layout: Linear three-way pinning, solder pin [P]: 5 mm, plug-in system: POWER COMBICON 5, Locking: without, type of packaging: packed in cardboard

The figure shows a 5-pos. version of the product

Your advantages

- ✓ Well-known mounting principle allows worldwide use
- ✓ Standard header – also suitable for connectors with automatically locking Click and Lock system
- ✓ Maximum flexibility when it comes to device design – one header for connectors with different connection technologies



Key Commercial Data

Packing unit	1 pc
Minimum order quantity	50 pc
GTIN	 4 046356 111362
GTIN	4046356111362
Weight per Piece (excluding packing)	6.400 g
Custom tariff number	85366930
Country of origin	Germany

Technical data

Item properties

Brief article description	Feed-through header
Plug-in system	POWER COMBICON 5
Type of contact	Male connector
Range of articles	PC 5/..-G

Printed-circuit board connector - PC 5/ 3-G-7,62 - 1720479

Technical data

Item properties

Pitch	7.62 mm
Number of positions	3
Mounting type	Wave soldering
Pin layout	Linear three-way pinning
Locking	without
Number of levels	1
Number of connections	3
Number of potentials	3
Pin connector pattern alignment	Standard

Electrical parameters

Nominal current	41 A
Nom. voltage	630 V
Rated voltage (III/3)	630 V
Rated voltage (III/2)	630 V
Rated voltage (II/2)	1000 V
Rated surge voltage (III/3)	6 kV
Rated surge voltage (III/2)	6 kV
Rated surge voltage (II/2)	6 kV

Material data - contact

Note	WEEE/RoHS-compliant, free of whiskers according to IEC 60068-2-82/ JEDEC JESD 201
Contact material	Cu alloy
Surface characteristics	hot-dip tin-plated
Metal surface contact area (top layer)	Tin (4 - 8 µm Sn)
Metal surface soldering area (top layer)	Tin (4 - 8 µm Sn)

Material data - housing

Housing color	green (6021)
Insulating material	PA
Insulating material group	I
CTI according to IEC 60112	600
Flammability rating according to UL 94	V0
Glow wire flammability index GWFI according to EN 60695-2-12	850
Glow wire ignition temperature GWIT according to EN 60695-2-13	775
Temperature for the ball pressure test according to EN 60695-10-2	125 °C

Flange specifications

Type of locking	without
-----------------	---------

Printed-circuit board connector - PC 5/ 3-G-7,62 - 1720479

Technical data

Flange specifications

Mounting flange	without
-----------------	---------

Dimensions for the product

Caption	Schematische Abbildung - weitere Details siehe Produktfamilienzeichnung im Download Center
Length [l]	29.25 mm
Width [w]	25.66 mm
Height [h]	19.29 mm
Pitch	7.62 mm
Height (without solder pin)	14.29 mm
Solder pin [P]	5 mm
Pin spacing	7.62 mm
Pin dimensions	0.8 x 1 mm

Dimensions for PCB design

Hole diameter	1.3 mm
Pin spacing	7.62 mm

Packaging information

Type of packaging	packed in cardboard
Pieces per package	50
Denomination packing units	Pcs.

General product information

Type of note	Notes on operation
Note	In accordance with IEC 61984, COMBICON connectors have no switching power (COC). During designated use, they must not be plugged in or disconnected when carrying voltage or under load.

Ambient conditions

Ambient temperature (storage/transport)	-40 °C ... 70 °C
Ambient temperature (assembly)	-5 °C ... 100 °C
Ambient temperature (operation)	-40 °C ... 100 °C (dependent on the derating curve)

Air clearances and creepage distances

Clearances and creepage distances	IEC 60664-1:2007-04
Specification	IEC 60664-1:2007-04
Minimum clearance - inhomogeneous field (III/3)	5.5 mm
Minimum clearance - inhomogeneous field (III/2)	5.5 mm
Minimum clearance - inhomogeneous field (II/2)	5.5 mm
Minimum creepage distance value (III/3)	8 mm
Minimum creepage distance value (III/2)	5.5 mm

Printed-circuit board connector - PC 5/ 3-G-7,62 - 1720479

Technical data

Air clearances and creepage distances

Minimum creepage distance value (II/2)	5.5 mm
--	--------

Standards and Regulations

Connection in acc. with standard	EN-VDE
	CUL
Flammability rating according to UL 94	V0

Environmental Product Compliance

China RoHS	Environmentally friendly use period: unlimited = EFUP-e
	No hazardous substances above threshold values

Drawings

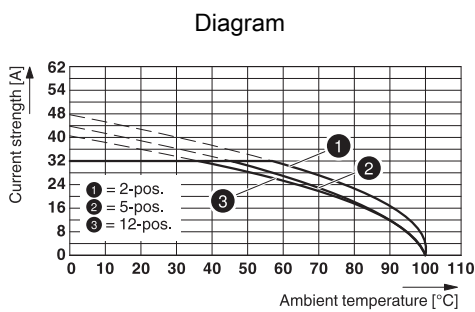

Derating curve for: SPC 5/...-ST-7,62 with PC 5/...-G-7,62

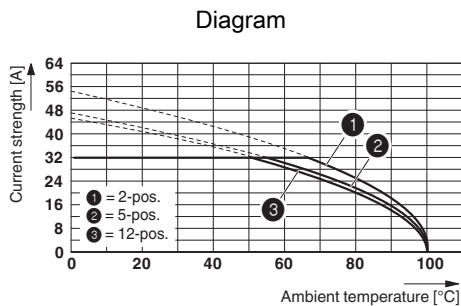
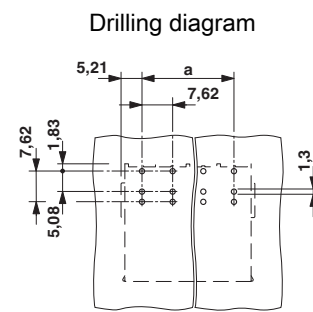

Derating curve for: PC 5/...-ST1-7,62 with PC 5/...-G-7,62
Conductor cross section: 6 mm²

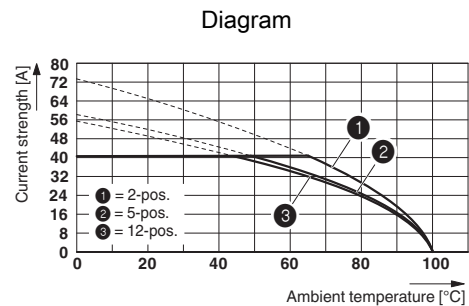

Derating curve for: PC 5/...-ST1-7,62 with PC 5/...-G-7,62
Conductor cross section: 10 mm²

Printed-circuit board connector - PC 5/ 3-G-7,62 - 1720479

Dimensional drawing

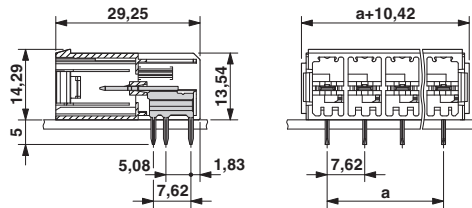

Classifications

eCl@ss

eCl@ss 10.0.1	27440402
eCl@ss 11.0	27460201
eCl@ss 4.0	27260700
eCl@ss 4.1	27260700
eCl@ss 5.0	27260700
eCl@ss 5.1	27260700
eCl@ss 6.0	27260700
eCl@ss 7.0	27440402
eCl@ss 9.0	27440402

ETIM

ETIM 3.0	EC001121
ETIM 4.0	EC002637
ETIM 6.0	EC002637
ETIM 7.0	EC002637

UNSPSC

UNSPSC 6.01	30211810
UNSPSC 7.0901	39121409
UNSPSC 11	39121409
UNSPSC 12.01	39121409
UNSPSC 13.2	39121409
UNSPSC 18.0	39121409
UNSPSC 19.0	39121409
UNSPSC 20.0	39121409
UNSPSC 21.0	39121409

Printed-circuit board connector - PC 5/ 3-G-7,62 - 1720479

Approvals

Approvals

Approvals

EAC / cULus Recognized

Ex Approvals

Approval details

EAC		B.01687
-----	--	---------

cULus Recognized		http://database.ul.com/cgi-bin/XYV/template/LISEXT/1FRAME/index.htm	E60425-19920722
	B	C	D
Nominal voltage UN	300 V	150 V	300 V
Nominal current IN	41 A	41 A	10 A

Accessories

Accessories

Coding element

Coding profile - CP-PC RD - 1701967

Coding profile, for plugging into the coding ribs of the plug at a later date, insulating material, color: Red



Labeled terminal marker

Printed-circuit board connector - PC 5/ 3-G-7,62 - 1720479

Accessories

Marker card - SK 7,62/3,8:FORTL.ZAHLEN - 0804549



Marker card, Card, white, labeled, horizontal: consecutive numbers 1 ... 10, 11 ... 20, etc. up to 91 ... 100, mounting type: adhesive, for terminal block width: 7.62 mm, lettering field size: 7.62 x 3.8 mm

Marker card - SK 3,8 REEL P7,62 WH CUS - 0825128



Marker card, Card, can be ordered: by card, white, labeled according to customer specifications, mounting type: adhesive, for terminal block width: 7.62 mm, lettering field size: continuous x 3.8 mm

Shroud

Accessories - POWERCOMBICON PCB-SHIELD - 1968387



Accessories, number of positions: 1, pitch: 0 mm, contact surface: Tin

Terminal marking

Marker card - SK U/3,8 WH:UNBEDRUCKT - 0803906



Marker card, Sheet, white, unlabeled, can be labeled with: PLOTMARK, CMS-P1-PLOTTER, Office printing systems, mounting type: adhesive, for terminal block width: 210 mm, lettering field size: 186 x 3.8 mm, Number of individual labels: 1440

Marker strip - SK 3,8 WH:REEL - 0805218



Marker strip, Roll, white, unlabeled, can be labeled with: THERMOMARK ROLL 2.0, THERMOMARK ROLL, THERMOMARK ROLL X1, THERMOMARK ROLLMASTER 300/600, THERMOMARK X1.2, mounting type: adhesive, for terminal block width: 90000 mm, lettering field size: continuous x 3.8 mm, Number of individual labels: 210000

Printed-circuit board connector - PC 5/ 3-G-7,62 - 1720479

Accessories

Additional products

Printed-circuit board connector - TSPC 5/ 3-ST-7,62 - 1728468



PCB connector, nominal cross section: 6 mm², color: green, nominal current: 41 A, rated voltage (III/2): 1000 V, contact surface: Tin, type of contact: Female connector, Number of potentials: 3, Number of rows: 1, Number of positions per row: 3, number of connections: 6, product range: TSPC 5/..-ST, pitch: 7.62 mm, connection method: Push-in spring connection, conductor/PCB connection direction: 0 °, Locking clip: - Locking clip, plug-in system: POWER COMBICON 5, Locking: without, type of packaging: packed in cardboard

Printed-circuit board connector - PC 5/ 3-ST1-7,62 - 1777736



PCB connector, nominal cross section: 6 mm², color: green, nominal current: 41 A, rated voltage (III/2): 1000 V, contact surface: Tin, type of contact: Female connector, Number of potentials: 3, Number of rows: 1, Number of positions per row: 3, number of connections: 3, product range: PC 5/..-ST1, pitch: 7.62 mm, connection method: Screw connection with tension sleeve, conductor/PCB connection direction: 0 °, Locking clip: - Locking clip, plug-in system: POWER COMBICON 5, Locking: without, type of packaging: packed in cardboard

Printed-circuit board connector - SPC 5/ 3-ST-7,62 - 1996029



PCB connector, nominal cross section: 6 mm², color: green, nominal current: 41 A, rated voltage (III/2): 1000 V, contact surface: Tin, type of contact: Female connector, Number of potentials: 3, Number of rows: 1, Number of positions per row: 3, number of connections: 3, product range: SPC 5/..-ST, pitch: 7.62 mm, connection method: Push-in spring connection, conductor/PCB connection direction: 0 °, Locking clip: - Locking clip, plug-in system: POWER COMBICON 5, Locking: without, type of packaging: packed in cardboard

Printed-circuit board connector - TSPC 5/ 3-STCL-7,62 - 1765421



PCB connector, nominal cross section: 6 mm², color: green, nominal current: 41 A, rated voltage (III/2): 1000 V, contact surface: Tin, type of contact: Female connector, Number of potentials: 3, Number of rows: 1, Number of positions per row: 3, number of connections: 6, product range: TSPC 5/..-STCL, pitch: 7.62 mm, connection method: Push-in spring connection, conductor/PCB connection direction: 0 °, Locking clip: - without locking clip, plug-in system: POWER COMBICON 5, Locking: Clip locking, type of packaging: packed in cardboard

Printed-circuit board connector - SPC 5/ 3-STCL-7,62 - 1718494



PCB connector, nominal cross section: 6 mm², color: green, nominal current: 41 A, rated voltage (III/2): 1000 V, contact surface: Tin, type of contact: Female connector, Number of potentials: 3, Number of rows: 1, Number of positions per row: 3, number of connections: 3, product range: SPC 5/..-STCL, pitch: 7.62 mm, connection method: Push-in spring connection, conductor/PCB connection direction: 0 °, Locking clip: - without locking clip, plug-in system: POWER COMBICON 5, Locking: Clip locking, type of packaging: packed in cardboard

Printed-circuit board connector - PC 5/ 3-G-7,62 - 1720479

Accessories

Printed-circuit board connector - PC 5/ 3-STCL1-7,62 - 1778078



PCB connector, nominal cross section: 6 mm², color: green, nominal current: 41 A, rated voltage (III/2): 1000 V, contact surface: Tin, type of contact: Female connector, Number of potentials: 3, Number of rows: 1, Number of positions per row: 3, number of connections: 3, product range: PC 5/..-STCL1, pitch: 7.62 mm, connection method: Screw connection with tension sleeve, conductor/PCB connection direction: 0 °, Locking clip: - without locking clip, plug-in system: POWER COMBICON 5, Locking: Clip locking, type of packaging: packed in cardboard

Printed-circuit board connector - IPC 5/ 3-G-7,62 - 1708394



PCB header, nominal cross section: 6 mm², color: green, nominal current: 41 A, rated voltage (III/2): 630 V, contact surface: Tin, type of contact: Female connector, Number of potentials: 3, Number of rows: 1, Number of positions per row: 3, number of connections: 3, product range: IPC 5/..-G, pitch: 7.62 mm, mounting: Wave soldering, pin layout: Linear pinning, solder pin [P]: 5 mm, plug-in system: POWER COMBICON 5, Locking: without, type of packaging: packed in cardboard

Printed-circuit board connector - IPC 5/ 3-GU-7,62 - 1708611



PCB header, nominal cross section: 6 mm², color: green, nominal current: 41 A, rated voltage (III/2): 630 V, contact surface: Tin, type of contact: Female connector, Number of potentials: 3, Number of rows: 1, Number of positions per row: 3, number of connections: 3, product range: IPC 5/..-GU, pitch: 7.62 mm, mounting: Wave soldering, pin layout: Linear pinning, solder pin [P]: 5 mm, plug-in system: POWER COMBICON 5, Locking: without, type of packaging: packed in cardboard

Printed-circuit board connector - IPCV 5/ 3-G-7,62 - 1708831



PCB header, nominal cross section: 6 mm², color: green, nominal current: 41 A, rated voltage (III/2): 630 V, contact surface: Tin, type of contact: Female connector, Number of potentials: 3, Number of rows: 1, Number of positions per row: 3, number of connections: 3, product range: IPCV 5/..-G, pitch: 7.62 mm, mounting: Wave soldering, pin layout: Linear pinning, solder pin [P]: 5 mm, plug-in system: POWER COMBICON 5, Locking: without, type of packaging: packed in cardboard
