

# PCB terminal block - MKDS 1,5/ 3-5,08

1715734

<https://www.phoenixcontact.com/us/products/1715734>

Please be informed that the data shown in this PDF document is generated from our Online Catalog. Please find the complete data in the user documentation. Our General Terms of Use for Downloads are valid.

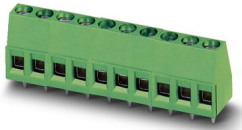

PCB terminal block, nominal current: 17.5 A, rated voltage (III/2): 400 V, nominal cross section: 1.5 mm<sup>2</sup>, number of potentials: 3, number of rows: 1, number of positions per row: 3, product range: MKDS 1,5, pitch: 5.08 mm, connection method: Screw connection with tension sleeve, screw head form: L Slotted, conductor/PCB connection direction: 0 °, color: green, Pin layout: Linear pinning, Solder pin [P]: 3.5 mm, number of solder pins per potential: 1, type of packaging: packed in cardboard. The article can be aligned to create different nos. of positions!

## Your advantages

- Well-known connection principle allows worldwide use
- Low temperature rise, thanks to maximum contact force
- Allows connection of two conductors
- The latching on the side enables various numbers of positions to be combined

# PCB terminal block - MKDS 1,5/ 3-5,08



1715734

<https://www.phoenixcontact.com/us/products/1715734>

## Commercial Data

Item number	1715734
Packing unit	1 pc
Minimum order quantity	250 pc
Sales Key	A01
Product Key	AALFGG
Catalog Page	Page 95 (C-1-2013)
GTIN	4017918024208
Weight per Piece (including packing)	4.28 g
Weight per Piece (excluding packing)	4.05 g
Customs tariff number	85369010
Country of origin	DE

1715734

<https://www.phoenixcontact.com/us/products/1715734>

## Technical Data

### Product properties

Type	PC terminal block can be aligned
Product line	COMBICON Terminals S
Product type	Printed circuit board terminal
Number of positions	3
Pitch	5.08 mm
Number of connections	3
Number of rows	1
Number of potentials	3
Pin layout	Linear pinning

### Electrical properties

Nominal current $I_N$	17.5 A
Nominal voltage $U_N$	400 V
Pollution degree	3
Rated voltage (III/3)	250 V
Rated surge voltage (III/3)	4 kV
Rated voltage (III/2)	400 V
Rated surge voltage (III/2)	4 kV

### Connection data

#### Connection technology

Type	PC terminal block can be aligned
Nominal cross section	1.5 mm <sup>2</sup>

#### Conductor connection

Connection method	Screw connection with tension sleeve
Conductor cross section solid	0.14 mm <sup>2</sup> ... 2.5 mm <sup>2</sup>
Conductor cross section flexible	0.14 mm <sup>2</sup> ... 1.5 mm <sup>2</sup>
Conductor cross section AWG	26 ... 14
Conductor cross section flexible, with ferrule without plastic sleeve	0.25 mm <sup>2</sup> ... 1.5 mm <sup>2</sup>
Conductor cross section, flexible, with ferrule, with plastic sleeve	0.25 mm <sup>2</sup> ... 1.5 mm <sup>2</sup>
2 conductors with same cross section, solid	0.14 mm <sup>2</sup> ... 1 mm <sup>2</sup>
2 conductors with same cross section, flexible	0.14 mm <sup>2</sup> ... 0.75 mm <sup>2</sup>
2 conductors with same cross section, flexible, with ferrule without plastic sleeve	0.25 mm <sup>2</sup> ... 0.5 mm <sup>2</sup>
2 conductors with the same cross section, flexible, with TWIN ferrule with plastic sleeve	0.5 mm <sup>2</sup> ... 1 mm <sup>2</sup>
Stripping length	7 mm
Torque	0.5 Nm ... 0.6 Nm

# PCB terminal block - MKDS 1,5/ 3-5,08



1715734

<https://www.phoenixcontact.com/us/products/1715734>

## Mounting

Mounting type Wave soldering	Wave soldering
Mounting type	Wave soldering
Drive form screw head	Slotted (L)

## Material specifications

### Material data - contact

Note	WEEE/RoHS-compliant, free of whiskers according to IEC 60068-2-82/JEDEC JESD 201
Contact material	Cu alloy
Surface characteristics	Tin-plated
Metal surface terminal point (top layer)	Tin (4 - 8 $\mu\text{m}$ Sn)
Metal surface soldering area (top layer)	Tin (4 - 8 $\mu\text{m}$ Sn)

### Material data - housing

Housing color	green (6021)
Insulating material	PA
Insulating material group	I
CTI according to IEC 60112	600
Flammability rating according to UL 94	V0
Glow wire flammability index GWFI according to EN 60695-2-12	850
Glow wire ignition temperature GWIT according to EN 60695-2-13	775
Temperature for the ball pressure test according to EN 60695-10-2	125 °C

## Notes

Note on application	For safe conductor connection, always adhere to a defined tightening torque. Particularly in the case of PCB terminal blocks with two or three positions, the individual solder pin for each contact point cannot compensate for this. That is why the terminal blocks must be supported during conductor connection (held with one hand, support on the housing).
---------------------	--

## Dimensions

Dimensional drawing	
Pitch	5.08 mm
Width [w]	15.24 mm
Height [h]	17.3 mm
Length [l]	9.8 mm
Installed height	13.8 mm

# PCB terminal block - MKDS 1,5/ 3-5,08



1715734

<https://www.phoenixcontact.com/us/products/1715734>

Solder pin length [P]	3.5 mm
-----------------------	--------

## Mechanical tests

### Test for conductor damage and slackening

Specification	IEC 60999-1:1999-11
Result	Test passed

### Pull-out test

Specification	IEC 60999-1:1999-11
Conductor cross section/conductor type/tractive force setpoint/actual value	0.14 mm <sup>2</sup> / solid / > 10 N
	0.14 mm <sup>2</sup> / flexible / > 10 N
	2.5 mm <sup>2</sup> / solid / > 50 N
	1.5 mm <sup>2</sup> / flexible / > 40 N

## Electrical tests

### Temperature-rise test

Specification	IEC 60947-7-4:2019-01
Requirement temperature-rise test	The sum of ambient temperature and temperature rise of the PCB terminal block shall not exceed the upper limiting temperature.

### Short-time withstand current

Specification	IEC 60947-7-4:2019-01
---------------	-----------------------

### Insulation resistance

Specification	IEC 60512-3-1:2002-02
Insulation resistance, neighboring positions	> 5 MΩ

### Air clearances and creepage distances |

Specification	IEC 60947-1:2007-06 + A1:2010-12 + A2:2014-09
Insulating material group	I
Comparative tracking index (IEC 60112)	CTI 600
Rated insulation voltage (III/3)	250 V
Rated surge voltage (III/3)	4 kV
minimum clearance value - non-homogenous field (III/3)	3 mm
minimum creepage distance (III/3)	3.2 mm
Note on connection cross section	With connected conductor 2.5 mm <sup>2</sup> (solid).
Rated insulation voltage (III/2)	400 V
Rated surge voltage (III/2)	4 kV
minimum clearance value - non-homogenous field (III/2)	3 mm
minimum creepage distance (III/2)	3 mm
Rated insulation voltage (II/2)	630 V
Rated surge voltage (II/2)	4 kV
minimum clearance value - non-homogenous field (II/2)	3 mm
minimum creepage distance (II/2)	3.2 mm

1715734

<https://www.phoenixcontact.com/us/products/1715734>

## Environmental and real-life conditions

### Vibration test

Specification	IEC 60068-2-6:2007-12
Frequency	10 - 150 - 10 Hz
Sweep speed	1 octave/min
Amplitude	0.35 mm (10 - 60.1 Hz)
Sweep speed	5g (60.1 - 150 Hz)
Test duration per axis	2.5 h

### Glow-wire test

Specification	IEC 60695-2-10:2013-04
Temperature	850 °C
Time of exposure	5 s

### Aging

Specification	IEC 60947-7-4:2019-01
---------------	-----------------------

### Ambient conditions

Ambient temperature (operation)	-40 °C ... 105 °C (Depending on the current carrying capacity/derating curve)
Ambient temperature (storage/transport)	-40 °C ... 70 °C
Relative humidity (storage/transport)	30 % ... 70 %
Ambient temperature (assembly)	-5 °C ... 100 °C

## Packaging specifications

Type of packaging	packed in cardboard
-------------------	---------------------

# PCB terminal block - MKDS 1,5/ 3-5,08



1715734

<https://www.phoenixcontact.com/us/products/1715734>

## Drawings

Dimensional drawing

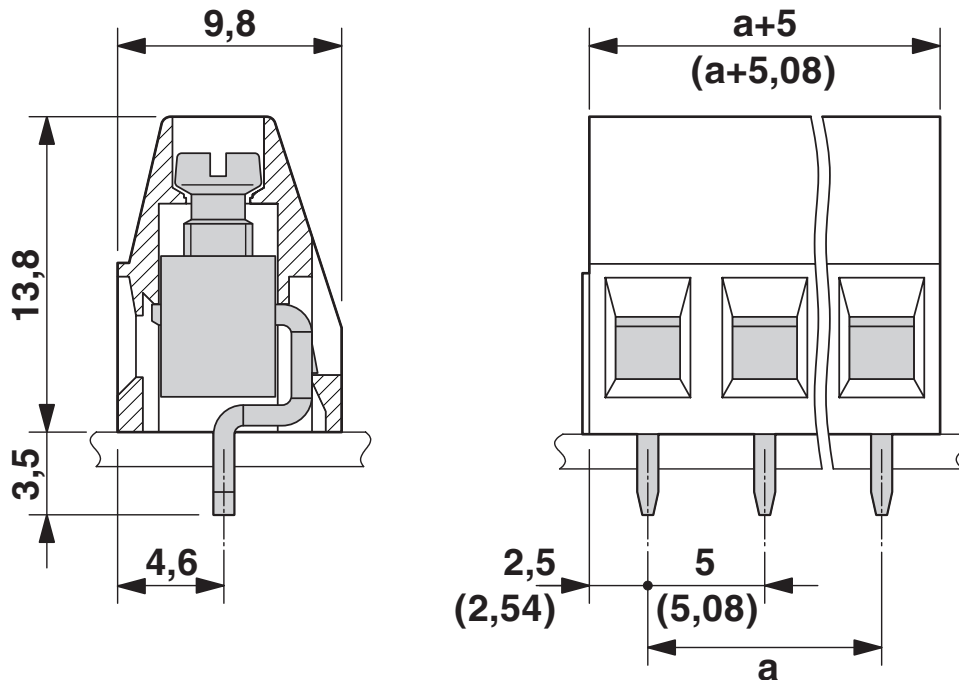

Diagram

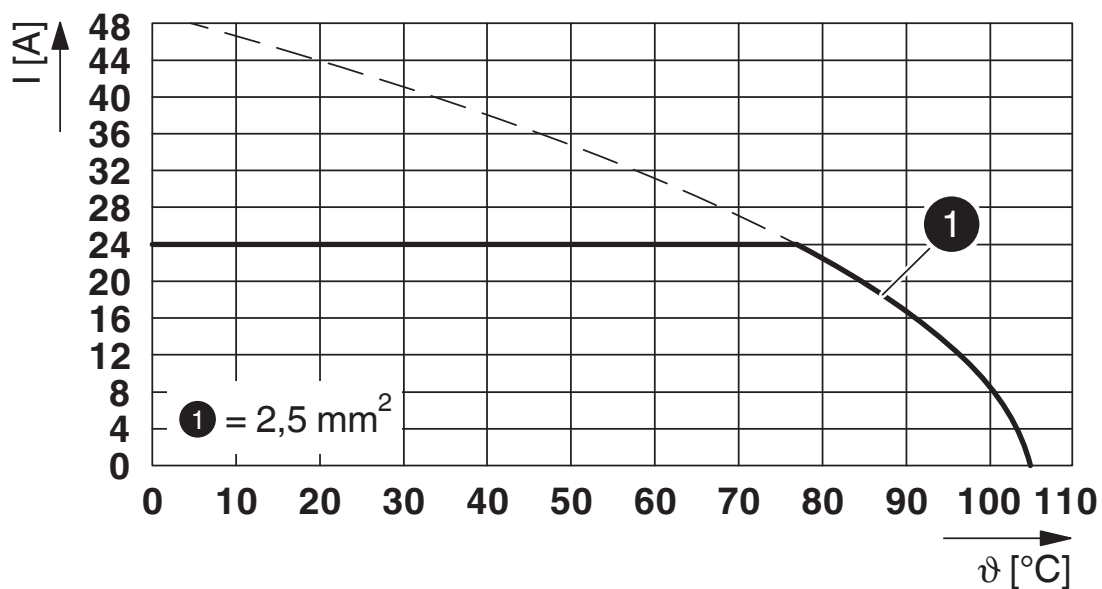

Type: MKDS 1,5/...-5,08

# PCB terminal block - MKDS 1,5/ 3-5,08

1715734

<https://www.phoenixcontact.com/us/products/1715734>



Drilling plan/solder pad geometry

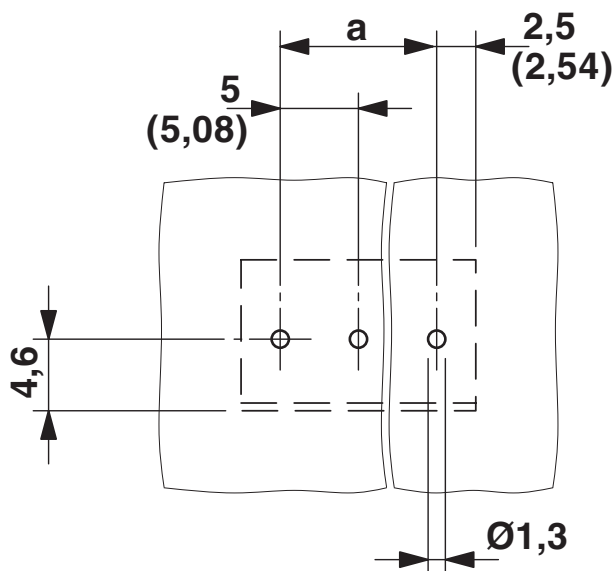



# PCB terminal block - MKDS 1,5/ 3-5,08





1715734

<https://www.phoenixcontact.com/us/products/1715734>

## Approvals

 <b>CSA</b> Approval ID: 13631				
	Nominal Voltage $U_N$	Nominal Current $I_N$	Cross Section AWG	Cross Section $\text{mm}^2$
Use group B	300 V	10 A	28 - 14	-
Use group D	300 V	10 A	28 - 14	-

 <b>EAC</b> Approval ID: B.01687				
--	--	--	--	--

 <b>cULus Recognized</b> Approval ID: E60425-19770427				
	Nominal Voltage $U_N$	Nominal Current $I_N$	Cross Section AWG	Cross Section $\text{mm}^2$
Use group B	300 V	15 A	30 - 14	-
Use group D	300 V	10 A	30 - 14	-

 <b>DNV GL</b> Approval ID: TAE00001EV				
--	--	--	--	--

# PCB terminal block - MKDS 1,5/ 3-5,08



1715734

<https://www.phoenixcontact.com/us/products/1715734>

## Classifications

### ECLASS

ECLASS-9.0	27440401
ECLASS-10.0.1	27440401
ECLASS-11.0	27460101

### ETIM

ETIM 8.0	EC002643
----------	----------

### UNSPSC

UNSPSC 21.0	39121400
-------------	----------

# PCB terminal block - MKDS 1,5/ 3-5,08



1715734

<https://www.phoenixcontact.com/us/products/1715734>

## Environmental Product Compliance

China RoHS	Environmentally friendly use period: unlimited = EFUP-e
	No hazardous substances above threshold values

# PCB terminal block - MKDS 1,5/ 3-5,08



1715734

<https://www.phoenixcontact.com/us/products/1715734>

## Accessories

### Screwdriver

Screwdriver - SZS 0,6X3,5 - 1205053

<https://www.phoenixcontact.com/us/products/1205053>



Actuation tool, for ST terminal blocks, insulated, also suitable for use as a bladed screwdriver, size: 0.6 x 3.5 x 100 mm, 2-component grip, with non-slip grip

### Marker card

Marker card - SK 5,08/3,8:FORTL.ZAHLEN - 0804293

<https://www.phoenixcontact.com/us/products/0804293>



Marker card, white, labeled, horizontal: consecutive numbers 1 ... 10, 11 ... 20, etc. up to 91 ... (99)100, mounting type: adhesive, for terminal block width: 5.08 mm, lettering field size: 5.08 x 3.8 mm

# PCB terminal block - MKDS 1,5/ 3-5,08

1715734

<https://www.phoenixcontact.com/us/products/1715734>

## Pitch spacer

Pitch spacer - RZ 1,25-MKDS 1,5 - 1702048

<https://www.phoenixcontact.com/us/products/1702048>



Pitch spacer, for adjusting the pitches between MKDS and GMKDS terminal blocks in mixed rows, 1.25 mm thick

---

## Insertion bridge

Insertion bridge - EBP 2- 5 - 1733169

<https://www.phoenixcontact.com/us/products/1733169>



Insertion bridge for connectors with 5.0 mm or 5.08 mm pitch

# PCB terminal block - MKDS 1,5/ 3-5,08

1715734

<https://www.phoenixcontact.com/us/products/1715734>

## Insertion bridge

Insertion bridge - EBP 3- 5 - 1733172

<https://www.phoenixcontact.com/us/products/1733172>



Insertion bridge for connectors with 5.0 mm or 5.08 mm pitch

---

## Crimping pliers

Crimping pliers - CRIMPFOX 6 - 1212034

<https://www.phoenixcontact.com/us/products/1212034>



Crimping pliers, for ferrules without insulating collar according to DIN 46228 Part 1 and ferrules with insulating collar according to DIN 46228 Part 4, 0.25 mm<sup>2</sup> ... 6.0 mm<sup>2</sup>, lateral entry, trapezoidal crimp

---

Phoenix Contact 2022 © - all rights reserved  
<https://www.phoenixcontact.com>

Phoenix Contact USA  
586 Fulling Mill Road  
Middletown, PA 17057, United States  
(+717) 944-1300  
[info@phoenixcon.com](mailto:info@phoenixcon.com)