

Flush-type connector - SACC-DSI-M 8MS-4CON-L180 - 1694347

Please be informed that the data shown in this PDF Document is generated from our Online Catalog. Please find the complete data in the user's documentation. Our General Terms of Use for Downloads are valid (<http://phoenixcontact.com/download>)



Sensor/actuator flush-type connector, male, 4-pos., M8, rear/screw mounting with M8 thread, with straight solder connection

Your advantages

- ✓ Easy PCB assembly: one-piece connectors for wave soldering
- ✓ Standard pin assignments and codings for signal transmission with a uniform design-in design
- ✓ For high transmission reliability: optional shield connection to the housing and latching on the PCB

Key Commercial Data

Packing unit	1 pc
Minimum order quantity	20 pc
GTIN	 4 017918 178680
GTIN	4017918178680
Weight per Piece (excluding packing)	5.900 g
Custom tariff number	85366990
Country of origin	Germany

Technical data

Ambient conditions

Ambient temperature (operation)	-40 °C ... 85 °C
	-40 °C ... 85 °C
Degree of protection	IP67

General

Rated current at 40°C	4 A
-----------------------	-----

Flush-type connector - SACC-DSI-M 8MS-4CON-L180 - 1694347

Technical data

General

Rated voltage	48 V AC
	60 V DC
Rated surge voltage	1.5 kV
Number of positions	4
Insulation resistance	≥ 100 MΩ
Coding	A - standard
Standards/regulations	M8 connector IEC 61076-2-104
Status display	No
Overvoltage category	II
Degree of pollution	3
Connection method	Solder pins
Torque	1 Nm ... 1.5 Nm (Installation-side)
Mounting type	Rear mounting M8 x 1 With locking nut
Thread type	M8 x 1

Material

Flammability rating according to UL 94	HB
Contact material	CuZn
Contact surface material	Au
Contact carrier material	PA 6.6
Material, knurls	Nickel-plated brass
Sealing material	NBR
Additional material specifications	EP (Grout material)

Cable

Standards/specifications	M8 connector IEC 61076-2-104
--------------------------	------------------------------

Standards and Regulations

Standards/specifications	M8 connector IEC 61076-2-104
Connection in acc. with standard	CUL
Flammability rating according to UL 94	HB

Environmental Product Compliance

REACH SVHC	Lead 7439-92-1
China RoHS	Environmentally Friendly Use Period = 25;
	For details about hazardous substances go to tab "Downloads", Category "Manufacturer's declaration"

Drawings

Flush-type connector - SACC-DSI-M 8MS-4CON-L180 - 1694347

Dimensional drawing

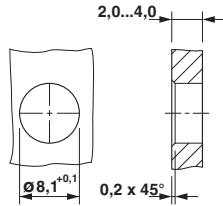

Schematic diagram

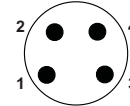

Pin assignment M8 plug, 4-pos., view male side

Housing cutout for M8 flush-type connector, connector, one-section

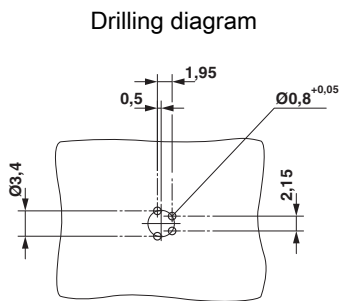

Drilling diagram

Dimensional drawing

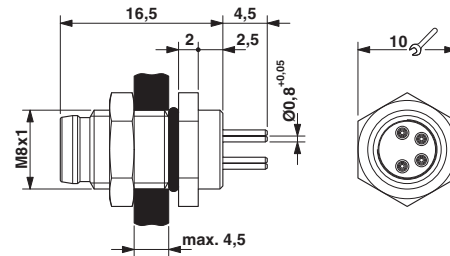

M8 flush-type plug

Drilling diagram

Classifications

eCl@ss

eCl@ss 10.0.1	27440102
eCl@ss 11.0	27440102
eCl@ss 4.0	27140800
eCl@ss 4.1	27140800
eCl@ss 5.0	27143400
eCl@ss 5.1	27143400
eCl@ss 6.0	27279200
eCl@ss 7.0	27440103
eCl@ss 8.0	27440103
eCl@ss 9.0	27440102

ETIM

ETIM 2.0	EC001297
ETIM 3.0	EC002061
ETIM 4.0	EC002062
ETIM 5.0	EC002061
ETIM 6.0	EC002061

Flush-type connector - SACC-DSI-M 8MS-4CON-L180 - 1694347

Classifications

UNSPSC

UNSPSC 6.01	31251501
UNSPSC 7.0901	31251501
UNSPSC 11	31251501
UNSPSC 12.01	31251501
UNSPSC 13.2	39121413
UNSPSC 18.0	39121413
UNSPSC 19.0	39121413
UNSPSC 20.0	39121413
UNSPSC 21.0	39121413

Approvals

Approvals

Approvals

UL Recognized / cUL Recognized / EAC / cULus Recognized

Ex Approvals

Approval details

UL Recognized		http://database.ul.com/cgi-bin/XYV/template/LISEXT/1FRAME/index.htm	FILE E 221474
Nominal voltage UN		30 V	
Nominal current IN		4 A	

cUL Recognized		http://database.ul.com/cgi-bin/XYV/template/LISEXT/1FRAME/index.htm	FILE E 221474
Nominal voltage UN		30 V	
Nominal current IN		4 A	

Flush-type connector - SACC-DSI-M 8MS-4CON-L180 - 1694347

Approvals

