



Inductors for Power Circuits

Wound Metallic Magnetic Material

SPM Series

SPM3015 Type

SPM3015

REMINDERS FOR USING THESE PRODUCTS

Before using these products, be sure to request the delivery specifications.

SAFETY REMINDERS

Please pay sufficient attention to the warnings for safe designing when using these products.

REMINDERS

- The storage period is less than 12 months. Be sure to follow the storage conditions (Temperature: 5 to 40°C, Humidity: 10 to 75% RH or less).
If the storage period elapses, the soldering of the terminal electrodes may deteriorate.
- Do not use or store in locations where there are conditions such as gas corrosion (salt, acid, alkali, etc.).
- Before soldering, be sure to preheat components.
The preheating temperature should be set so that the temperature difference between the solder temperature and chip temperature does not exceed 150°C.
- Soldering corrections after mounting should be within the range of the conditions determined in the specifications.
If overheated, a short circuit, performance deterioration, or lifespan shortening may occur.
- When embedding a printed circuit board where a chip is mounted to a set, be sure that residual stress is not given to the chip due to the overall distortion of the printed circuit board and partial distortion such as at screw tightening portions.
- Self heating (temperature increase) occurs when the power is turned ON, so the tolerance should be sufficient for the set thermal design.
- Carefully lay out the coil for the circuit board design of the non-magnetic shield type.
A malfunction may occur due to magnetic interference.
- Use a wrist band to discharge static electricity in your body through the grounding wire.
- Do not expose the products to magnets or magnetic fields.
- Do not use for a purpose outside of the contents regulated in the delivery specifications.
- The products listed on this catalog are intended for use in general electronic equipment (AV equipment, telecommunications equipment, home appliances, amusement equipment, computer equipment, personal equipment, office equipment, measurement equipment, industrial robots) under a normal operation and use condition.
The products are not designed or warranted to meet the requirements of the applications listed below, whose performance and/or quality require a more stringent level of safety or reliability, or whose failure, malfunction or trouble could cause serious damage to society, person or property.
If you intend to use the products in the applications listed below or if you have special requirements exceeding the range or conditions set forth in the each catalog, please contact us.

- (1) Aerospace/Aviation equipment
- (2) Transportation equipment (cars, electric trains, ships, etc.)
- (3) Medical equipment
- (4) Power-generation control equipment
- (5) Atomic energy-related equipment
- (6) Seabed equipment
- (7) Transportation control equipment

- (8) Public information-processing equipment
- (9) Military equipment
- (10) Electric heating apparatus, burning equipment
- (11) Disaster prevention/crime prevention equipment
- (12) Safety equipment
- (13) Other applications that are not considered general-purpose applications

When designing your equipment even for general-purpose applications, you are kindly requested to take into consideration securing protection circuit/device or providing backup circuits in your equipment.

Inductors for Power Circuits

Wound Metallic Magnetic Material

Product compatible with RoHS directive
Halogen-free
Compatible with lead-free solders

Overview of SPM3015 Type

FEATURES

- Magnetic shield type wound inductor for power circuits using a metallic magnetic material.
- Low-profile product.
- Compared to ferrite wound type inductors, it is possible to achieve large current, low Rdc, and compactness.
- Low inductance variance in high-temperature environments with good DC superimposition characteristics.
- Metallic magnetic material is used, and the structure has an integrated molded coil, so hum noise is lower than with core adhesive coils.

APPLICATION

Smart phones, tablet terminals, laptop computers, HDDs, servers, VRMs, compact power supply modules, other

PART NUMBER CONSTRUCTION

| | | | | | | | | |
|-------------|----------------------------|-------------|-----------------|--------|-----------------|------|----------------------|------|
| SPM | 3015 | T | - | R47 | M | | | |
| Series name | LxWxH Dimensions (mm max.) | | Packaging style | | Inductance (μH) | | Inductance tolerance | |
| | 3015 | 3.2x3.0x1.5 | T | Taping | R47 | 0.47 | M | ±20% |
| | | | | | 1R5 | 1.5 | | |
| | | | | | 2R2 | 2.2 | | |

OPERATING TEMPERATURE RANGE, PACKAGE QUANTITY, PRODUCT WEIGHT

| Type | Temperature range | | Package quantity (pieces/reel) | Individual weight (g) |
|---------|--------------------------------|-------------------------------|-----------------------------------|--------------------------|
| | Operating temperature* (°C) | Storage temperature** (°C) | | |
| SPM3015 | -40 to +125 | -40 to +125 | 2000 | 0.0661 |

* Operating temperature range includes self-temperature rise.

** The Storage temperature range is for after the circuit board is mounted.

- RoHS Directive Compliant Product: See the following for more details related to RoHS Directive compliant products. <http://product.tdk.com/en/environment/rohs/>
- Halogen-free: Indicates that Cl content is less than 900ppm, Br content is less than 900ppm, and that the total Cl and Br content is less than 1500ppm.

 Please be sure to request delivery specifications that provide further details on the features and specifications of the products for proper and safe use. Please note that the contents may change without any prior notice due to reasons such as upgrading.

SPM3015 Type

RECOMMENDED REFLOW PROFILE

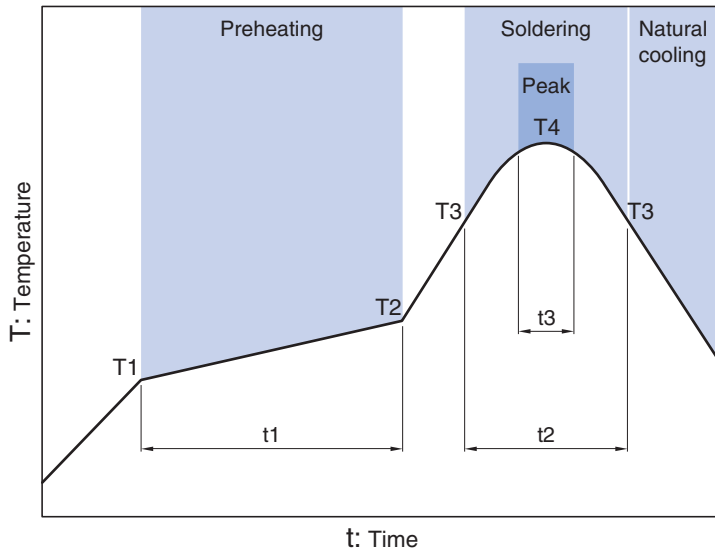

| Preheating | | | Soldering | | Peak | |
|------------|-------|------|-----------|------|-------|----------|
| Temp. | Temp. | Time | Temp. | Time | Temp. | Time |
| T1 | T2 | t1 | T3 | t2 | T4 | t3 |
| 150°C | 180°C | 120s | 230°C | 30s | 260°C | 10s max. |

SPM3015 Type

SHAPE & DIMENSIONS

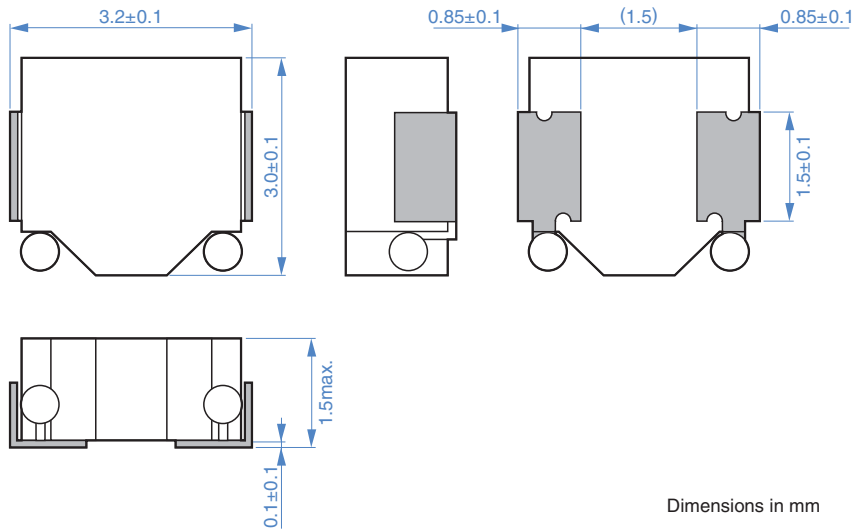

RECOMMENDED LAND PATTERN

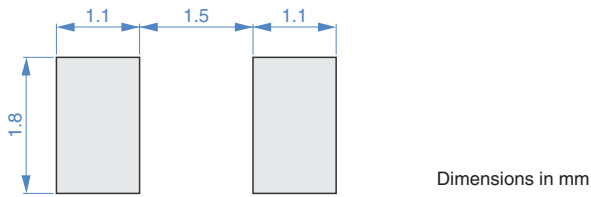

SPM3015 Type

ELECTRICAL CHARACTERISTICS

CHARACTERISTICS SPECIFICATION TABLE

| L (μH) | Tolerance | L measuring frequency (kHz) | DC resistance | | Rated current* | | | Part No. |
|------------------------|------------|-----------------------------------|--------------------------|--------------------------|-----------------|-----------------|-----------------|---------------|
| | | | ($\text{m}\Omega$)max. | ($\text{m}\Omega$)typ. | Idc1 (A)max. | Idc1 (A)typ. | Idc2 (A)typ. | |
| 0.47 | $\pm 20\%$ | 100 | 34.5 | 31.4 | 6.1 | 8.1 | 4.3 | SPM3015T-R47M |
| 1.0 | $\pm 20\%$ | 100 | 52.9 | 48.1 | 5.1 | 6.8 | 3.5 | SPM3015T-1R0M |
| 1.5 | $\pm 20\%$ | 100 | 73.1 | 66.4 | 3.5 | 4.7 | 3.0 | SPM3015T-1R5M |
| 2.2 | $\pm 20\%$ | 100 | 97.4 | 88.5 | 3.0 | 4.0 | 2.6 | SPM3015T-2R2M |
| 3.3 | $\pm 20\%$ | 100 | 151.9 | 138.0 | 2.4 | 3.2 | 2.0 | SPM3015T-3R3M |
| 4.7 | $\pm 20\%$ | 100 | 228.1 | 198.3 | 2.1 | 2.8 | 1.8 | SPM3015T-4R7M |

* Rated current: smaller value of either Idc1 or Idc2.

Idc1: When based on the inductance change rate (30% below the initial value)

Idc2: When based on the temperature increase (Temperature increase of 40°C by self heating)

Measurement equipment

| Measurement item | Product No. | Manufacturer |
|--------------------|---------------------|----------------------|
| L | 4284A | Agilent Technologies |
| DC resistance | AX-111A | ADEX |
| Rated current Idc1 | 4284A+42841A+42842C | Agilent Technologies |

* Equivalent measurement equipment may be used.

SPM3015 Type

ELECTRICAL CHARACTERISTICS

L FREQUENCY CHARACTERISTICS GRAPH

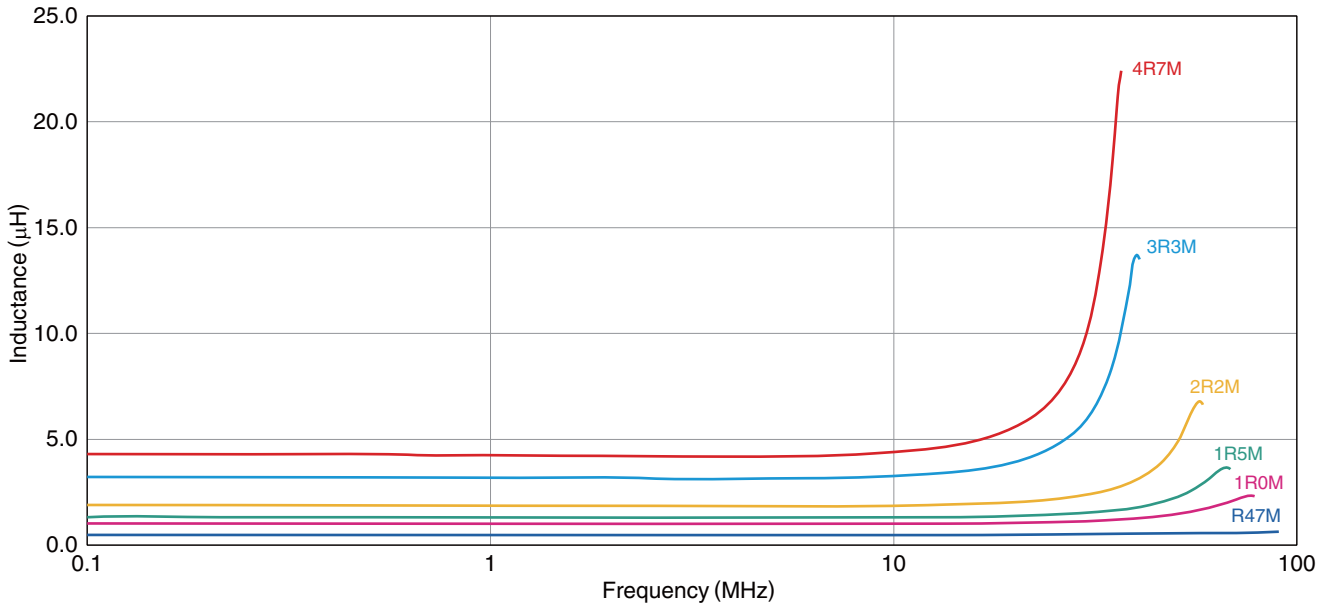

○ Measurement equipment

| Product No. | Manufacturer |
|-------------|----------------------|
| 4294A | Agilent Technologies |

* Equivalent measurement equipment may be used.

 Please be sure to request delivery specifications that provide further details on the features and specifications of the products for proper and safe use. Please note that the contents may change without any prior notice due to reasons such as upgrading.

SPM3015 Type

ELECTRICAL CHARACTERISTICS

INDUCTANCE VS. DC BIAS CHARACTERISTICS GRAPH

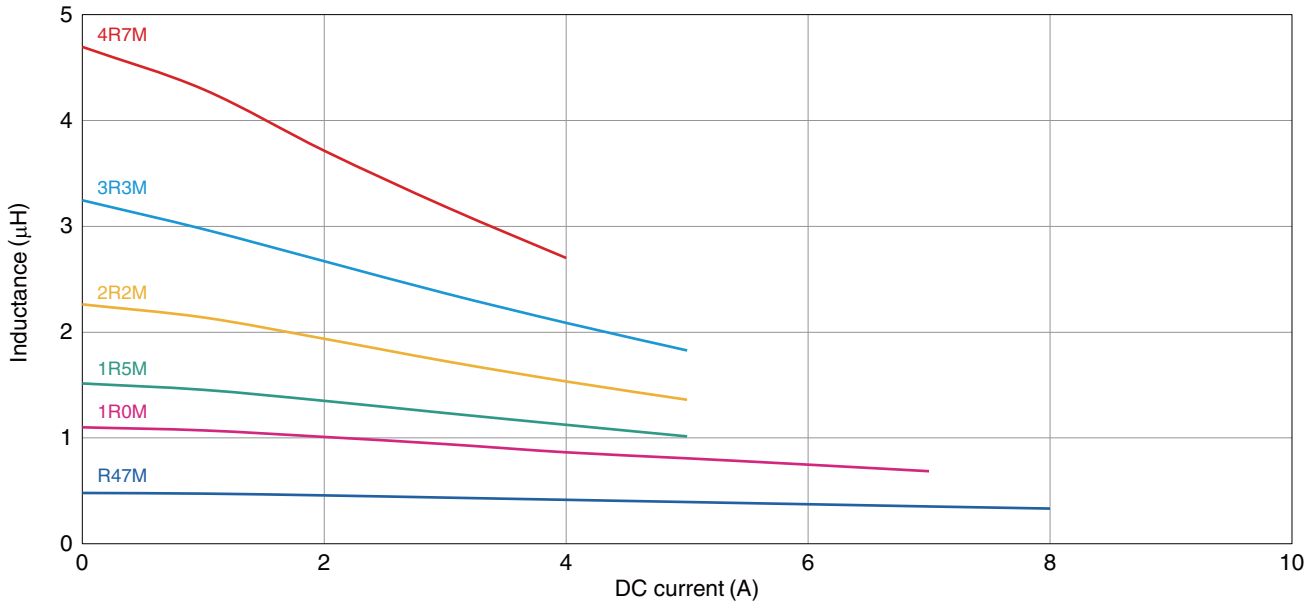

○ Measurement equipment

| Product No. | Manufacturer |
|---------------------|----------------------|
| 4284A+42841A+42842C | Agilent Technologies |

* Equivalent measurement equipment may be used.

SPM3015 Type

PACKAGING STYLE

REEL DIMENSIONS

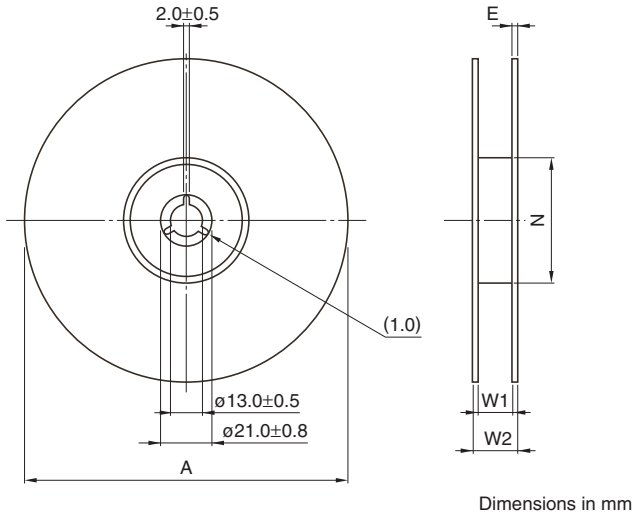

| Type | A | W1 | W2 | N | E |
|---------|------|-----|------|-----|-----|
| SPM3015 | ∅180 | 9.5 | 11.9 | ∅60 | 1.2 |

* These values are typical values.

TAPE DIMENSIONS

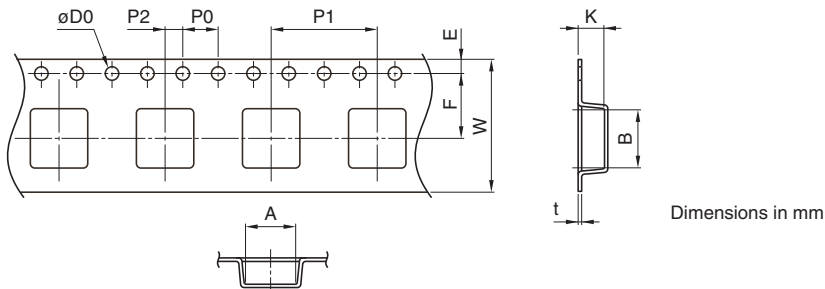

| Type | A | B | ∅D0 | E | F | P0 | P1 | P2 | W | K | t |
|---------|-----|-----|------------|----------|----------|----------|----------|---------|---------|------|------|
| SPM3015 | 3.2 | 3.4 | 1.5+0.1/-0 | 1.75±0.1 | 3.50±0.1 | 4.0±0.05 | 4.0±0.05 | 2.0±0.1 | 8.0±0.1 | 1.65 | 0.25 |

! Please be sure to request delivery specifications that provide further details on the features and specifications of the products for proper and safe use. Please note that the contents may change without any prior notice due to reasons such as upgrading.

Mouser Electronics

Authorized Distributor

Click to View Pricing, Inventory, Delivery & Lifecycle Information:

[TDK:](#)

[SPM3015T-R47M](#) [SPM3015T-1R0M](#) [SPM3015T-1R5M](#) [SPM3015T-2R2M](#) [SPM3015T-3R3M](#) [SPM3015T-4R7M](#)