

NRF Series Circuit Protectors

Snaps into a 16-mm-diameter hole

Wide variety of applications such as office automation equipment

- 16-mm-dia fuse holder size
- More than 1,000 repeat operations
- Snap-on mounting
- Visible trip indicator
- Variety of rated currents
- Available with auxiliary contact which can be used to make an alarm or control circuit
- Solder or quick-connect terminations
- Round design and colorful bezels
- Mounting on 35-mm-width DIN rails is made possible by using a special adapter
- Cycling trip-free mechanism

This product is recognized by Underwriters Laboratories under UL1077 as a "Supplementary Protector."



Applicable Standards	Mark	Certification Organization / File No.
UL1077		UL recognized File No. E68029
CSA C22.2 No. 235 (Note 1)		CSA file No. LR83454
EN60934 (Note 2)		TÜV SÜD
GB17701		CCC No. 2005010309151798

For details, see the list of standard certified products in the back of this catalog.
Note 1: Only NRF series circuit protectors without manual OFF mechanism are certified by CSA.

Note 2: NRF110, rated current 8A, 10A, and 15A, without manual OFF mechanism

- Specify a rated current and the bezel color code in place of [1] [2].

Package Quantity: 1

Auxiliary Contact	Internal Circuit	Manual OFF Mechanism	Part No.	Standard	Designation Code	
					[1] Rated Current	[2] Bezel Color
w/o Auxiliary Contact		Without	NRF110 [2]-[1]	UL CSA CCC	0.3A, 0.5A	
			NRF110 [2]-[1]	UL CSA CCC TÜV (Note)	1A, 2A, 3A, 5A, 8A, 10A, 15A	
		With	NRF210 [2]-[1]	UL CCC	0.3A, 0.5A	
			NRF210 [2]-[1]	UL CCC	1A, 2A, 3A, 5A, 8A, 10A, 15A	
w/Auxiliary Contact		Without	NRF111 [2]-[1]	UL CSA CCC	0.3A, 0.5A, 1A, 2A, 3A, 5A, 8A, 10A, 15A	
		With	NRF211 [2]-[1]	UL CCC		

Bezel Color	Code
Black	Blank (standard color)
Green	G
Red	R
Blue	S
White	W
Yellow	Y

Note: TÜV approved models are for 8A, 10A, and 15A only. When ordering the TÜV approved models, specify "-EN" at the end of the Part No.

Part No. Development

When ordering, specify the Part No. the rated current, and the bezel color code.

[Example]

NRF 2 11 R - 3A

Model	2	1	Rated Current	0.3A, 0.5A, 1A, 2A, 3A, 5A, 8A, 10A, 15A
Manual OFF Mechanism	11			
		2	2	Bezel Color
Auxiliary Contact				

Without	With
1	2
10	11

Bezel Color	Code
Black	Blank (standard color)
Green	G
Red	R
Blue	S
White	W
Yellow	Y

Wiring Example

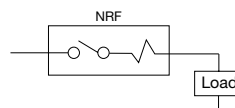

Manual OFF Mechanism

Manual OFF mechanism opens the main contacts by pressing the button, convenient for checking the circuit with power OFF. When manually turning OFF, make sure that the current is not applied (under no-load condition).

NRF Series Circuit Protectors

Specifications

Protection Method	Thermal tripping
Internal Circuit	Series trip Series trip (w/auxiliary contact)
No. of Poles	1 pole
Rated Voltage	250V AC, 32V DC
Rated Current	0.3A, 0.5A, 1A, 2A, 3A, 5A, 8A, 10A, 15A
Minimum Applicable Load	24V AC/DC 100mA (reference value)
Rated Interrupting Current	300 mA to 5A: Rated current × 6 8, 10, and 15A: Rated current × 10 (Turns on when the main circuit is off, including tripping.)
Auxiliary Contact Rating	1NO (contact output) 125V AC / 32V DC, 50mA
Reference Temperature	25°C
Operating Temperature	-10 to +60°C (no freezing)
Storage Temperature	-30 to +80°C (no freezing)
Operating Humidity	45 to 85% RH (no condensation) (Note 1)
Storage Humidity	45 to 85% RH (no condensation)
Trip Time (at 25 °C)	No trip at the rated current Within 1 hour at 135% the rated current
Reset Time	60 sec minimum (Note 2)
Vibration Resistance	100 m/s ² (10 to 55 Hz)
Shock Resistance	Damage limits: 1000 m/s ² , Operating extremes: 500 m/s ²
Life	Overcurrent durability: 1,000 operations minimum (tripping at 200% the rated current) Mechanical life (with manual OFF mechanism): 240 operations minimum (switching at no load)
Insulation Resistance	100 MΩ minimum (500V DC megger)
Dielectric Strength	Between main contacts and between main contact and ground: 2000V AC, 1 minute Between main and auxiliary contacts: 1500V AC, 1 minute
Terminal Style	Main terminal: Tab terminal #250 Auxiliary contact terminal: 1.4W × 0.2mm thick solder terminal
Degree of Protection	IP40 (IEC 60529)
Weight (Approx.)	15g

Note 1: The rated current is the value at the reference ambient temperature of 25°C, and varies with the operating temperature. The rated current can be corrected according to the temperature correction curve.

Note 2: Reset time is the value at the reference ambient temperature of 25°C.

Time Delay Curves

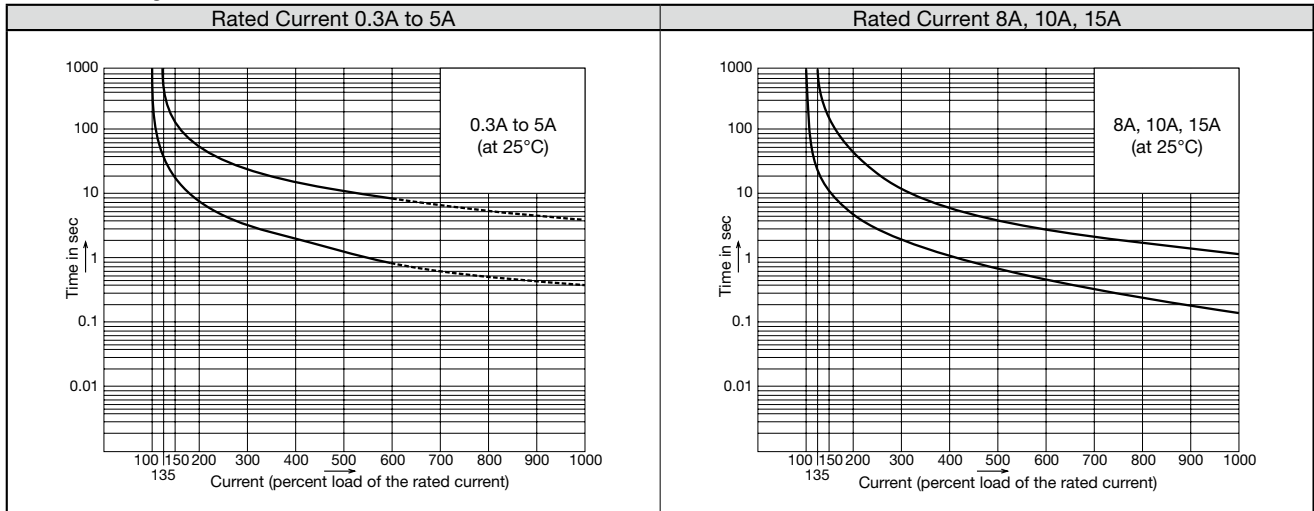

Note: Dashed lines are reference values.

Overcurrent Trip Time

0.3A to 5A

Percent of Rated Current	100%	135%	150%	200%	400%	600%
Trip Time (sec)	NO TRIP	30 to 3600	16 to 120	7 to 55	2 to 17	0.9 to 8.5

(Ambient temperature + 25°C)

8 to 15A

Percent of Rated Current	100%	135%	150%	200%	400%	600%	800%	1000%
Trip Time (sec)	NO TRIP	28 to 3600	10 to 130	5 to 50	1 to 7	0.45 to 3	0.25 to 1.8	0.15 to 1.2

(Ambient temperature + 25°C)

Applications

NRF series circuit protectors are small, high-performance over-current protectors developed for use in control circuits and small electrical equipment. Because they can be easily reset, they are suited for use in relay circuits, motor circuits, heater circuits, transformers, solenoids, solenoid valves, semiconductor circuits, and many other applications.

[Application Examples]

Office Automation Equipment

Copiers, shredders, personal computers, word processors, fax machines, printers, computer terminals, communication equipment, and power supplies.

Measuring Instruments

Electrical measuring instruments, industrial meters, analyzers, recorders, data processors, test equipment, and chemical equipment

Industrial Machines

CNC equipment, robots, molding machines, processing machines, packaging machines, and carriers

Business machines

Medical equipment, vending machines, hairdresser's equipment, recreation and game machines, and small printing machines

Electric Controller and Instrumentation Equipment

Automatic control devices, electronic equipment, and instrumentation boards

- Flush Silhouette
- Switches & Pilot Lights
- Display Lights
- LED Illumination Units
- Display Units
- Safety Products
- Terminal Blocks
- Comm. Terminals
- AS-Interface
- Relays & Timers
- Sockets
- Circuit Protectors
- Power Supplies
- PLCs & SmartRelay
- Operator Interfaces
- Sensors
- Control Stations
- Explosion Protection
- References

NRF Series Circuit Protectors

Rated Current vs Internal Resistance

Rated Current	Internal Resistance (Ω) $\pm 15\%$	Remarks
0.3A	9.08	at 25°C
0.5A	3.27	
1A	0.81	
2A	0.235	
3A	0.0922	
5A	0.0503	
8A	0.0085	
10A	0.0095	
15A	0.0064	

The internal resistance tends to be larger for smaller rated currents. When the circuit protector is used in a low-voltage circuit, voltage drop should be taken into consideration.

Temperature Correction Curve

The rated current is based on an ambient temperature of 25°C. Since a thermal tripping method is employed, the rated current should be corrected according to the ambient temperature with reference to the curves shown below.

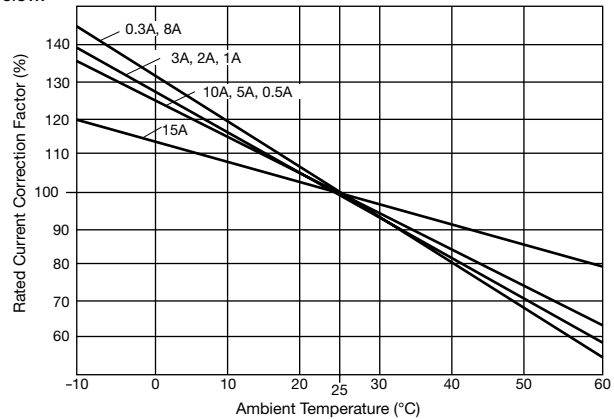

Dimensions

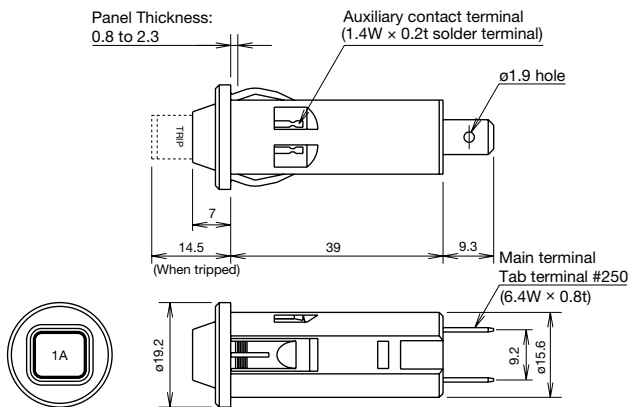

Mounting Hole

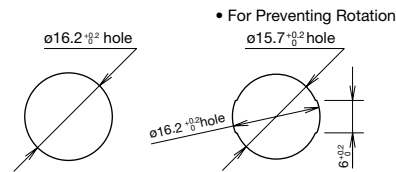

* Chamfering on the front edge of the mounting hole is recommended for easy insertion.

Accessories

35-mm-wide DIN Rail Mount Adapter

Part No.	Ordering No.	Package Quantity
NRF-D	NRF-DPN05	5

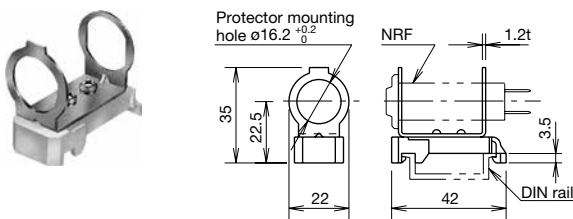

Surface Mount Adapter

Part No.	Ordering No.	Package Quantity
NRF-M	NRF-MPN10	10

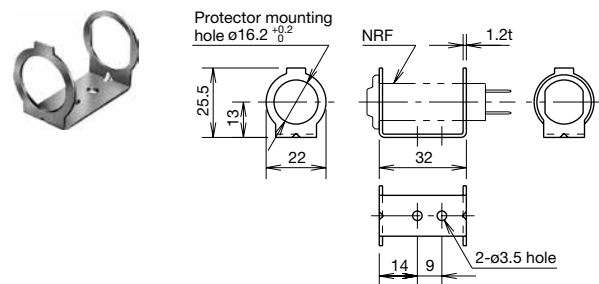

All dimension in mm.

Instructions

- Since the NRF is designed for protection against overload, it should be used within the rated interrupting current. An excessive overcurrent may affect the bimetal characteristics or damage the internal mechanism.
- After tripping, the NRF cannot be reset until the bimetal cools down. Allow the NRF at least 60 seconds before resetting. When the NRF is used at an ambient temperature higher than the reference temperature, resetting sometimes fails even after 60 seconds because it takes a long time to cool down the bimetal.
- The NRF may not trip at an instantaneous overcurrent due to its principle.

- The NRF is shipped in the ON status. To confirm operation of the models without manual OFF mechanism, apply approximately 200% the rated current to trip the NRF.
- When installing quick connect receptacles to the terminals, hold the NRF body and press it into the quick connect receptacles.
- Unlike conventional switches, the models with manual OFF mechanism are not suited for frequent switching due to their construction. (Their mechanical life is 240 operations at minimum when switching at no load.)
- The models with manual OFF mechanism should be operated without load.

Recommended Soldering Conditions

Solder the main terminal at a temperature of 390°C within 10 seconds using a 60W soldering iron. Solder the auxiliary/alarm terminal at a temperature of 350°C within 3 seconds using a 60W soldering iron. (Sn-Ag-Cu lead-free solder is recommended.) When solder-

ing, do not touch the circuit protector housing, auxiliary and alarm contacts with the soldering iron, and do not bend the terminals or pull the wires. Check your actual soldering conditions before soldering.

Mouser Electronics

Authorized Distributor

Click to View Pricing, Inventory, Delivery & Lifecycle Information:

IDEC:

[NRF-110-10A](#) [NRF-110-8A](#) [NRF-111-10A](#) [NRF-111S-3A](#) [NRF-210-3A](#) [NRF-110-1A](#) [NRF-110-2A](#) [NRF210-10A](#)
[NRF-111-1A](#) [NRF-111-2A](#) [NRF-110R-15A](#) [NRF-110W-5A](#) [NRF-110R-2A](#) [NRF-110R-5A](#) [NRF-210-1A](#) [NRF-111-3A](#)
[NRF-211-10A](#) [NRF-211-3A](#) [NRF111-15A](#) [NRF111R-5A](#) [NRF211-10A](#) [NRF111S-2A](#) [NRF210-5A](#) [NRF110W-5A](#)
[NRF111-0.3A](#) [NRF111S-5A](#) [NRF111Y-15A](#) [NRF210-1A](#) [NRF211-3A](#) [NRF111S-3A](#) [NRF210-15A](#) [NRF110W-1A](#)
[NRF210W-3A](#) [NRF110R-1A](#) [NRF110W-3A](#) [NRF110-7A](#) [NRF-110-7A](#) [NRF-110R-10A](#) [NRF-210-2A](#) [NRF-210-5A](#)
[NRF110-2A](#) [NRF110R-2A](#) [NRF110R-15A](#) [NRF210R-10A](#) [NRF-111R-5A](#) [NRF-210R-10A](#) [NRF110-8A](#) [NRF110R-](#)
[10A](#) [NRF111G-3A](#) [NRF210R-15A](#) [NRF-110-3A](#) [NRF-110-5A](#) [NRF-111-5A](#) [NRF-210R-15A](#) [NRF-210W-3A](#)
[NRF110R-5A](#) [NRF-110W-1A](#) [NRF-111-0.3A](#) [NRF-111G-3A](#) [NRF-110-15A](#) [NRF-111-15A](#) [NRF-111S-2A](#) [NRF-111S-](#)
[5A](#) [NRF111-1A](#) [NRF210-2A](#) [NRF-110R-1A](#) [NRF-110W-3A](#) [NRF-111Y-15A](#) [NRF-210-10A](#) [NRF-210-15A](#)