

PLEASE CHECK WWW.MOLEX.COM FOR LATEST PART INFORMATION

Part Number: [1053251008](#)
Status: **Active**
Overview: Nano-Fit™ Power Connectors
Description: Nano-Fit™ Terminal Position Assurance (TPA) Retainer, 2.50mm Pitch, 8 Circuits, Black

Documents:

3D Model	Packaging Specification PK-105325-100-000 (PDF)
Drawing (PDF)	RoHS Certificate of Compliance (PDF)
Product Specification PS-105300-100-001 (PDF)	Product Literature (PDF)

General

Product Family	Accessories
Series	105325
Comments	Operating temperature is -40#C to +105#C for tin and -40#C to +115#C for gold
Component Type	Terminal Position Assurance
Overview	Nano-Fit™ Power Connectors
Product Literature Order No	987651-1223
Product Name	Nano-Fit™, TPA - Term Pos Assurance
UPC	889056028615

Physical

Circuits (Loaded)	8
Color - Resin	Black
Lock to Mating Part	Yes
Material - Resin	Nylon
Net Weight	0.200/g
Number of Rows	1
Packaging Type	Bag
Temperature Range - Operating	-40°C to +105°C, -40°C to +115°C

Material Info

Reference - Drawing Numbers

Packaging Specification	PK-105325-100-000
Product Specification	PS-105300-100-001
Sales Drawing	SD-105325-100-000

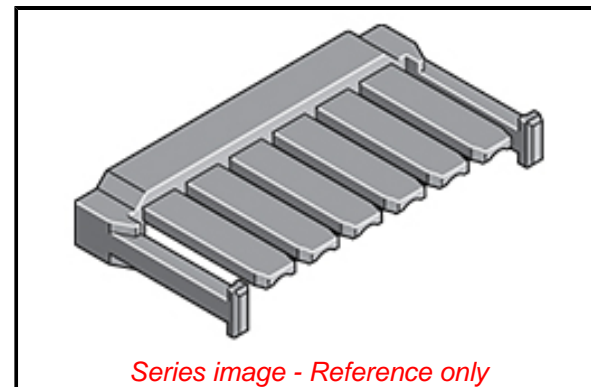

EU ELV

Not Reviewed

EU RoHS

Not Reviewed

REACH SVHC

Not Reviewed

Halogen-Free

Status

Not Reviewed

Need more information on product environmental compliance?

Email productcompliance@molex.com
Please visit the [Contact Us](#) section for any non-product compliance questions.

China ROHS	Not Reviewed
ELV	Not Reviewed
RoHS Phthalates	Not Reviewed

Search Parts in this Series

[105325](#) Series

Use With

Nano-Fit™ TPA Receptacle Housing
[105307](#) , [105308](#)

PLEASE CHECK WWW.MOLEX.COM FOR LATEST PART INFORMATION