

80mA Low Noise Ultra Low Dropout Voltage Regulator

DESCRIPTION

The TS5204 series is an efficient linear voltage regulator with ultra-low noise output, very low dropout voltage (typically 20mV at light loads and 300mV at 80mA), and very low power consumption (500µA at 50mA), providing high output current even when the application requires very low dropout voltage.

The TS5204 series includes a precision voltage reference, current limit, over temperature shutdown and reversed battery protection.

FEATURES

- Ultra-Low Noise Output
- Output Current up to 80mA
- Low Dropout Voltage
- Low Power Consumption
- Internal Current Limit
- Thermal Shutdown Protection
- RoHS Compliant
- Halogen-free according to IEC 61249-2-21

APPLICATION

- Cellular Telephones
- Palmtops, Notebook Computers
- Battery Powered Equipment
- Consumer and Personal Electronics
- SMPS Post Regulator and DC to DC Modules
- High-efficiency Linear Power Supplies
- Portable Application



SOT-23
Pin Definition:
 1. Output
 2. Input
 3. Ground



SOT-89
Pin Definition:
 1. Output
 2. Ground
 3. Input

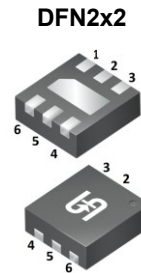

DFN2x2
Pin Definition:
 1. Output
 2. N/C
 3. Ground
 4. N/C
 5. N/C
 6. Input

TYPICAL APPLICATION CIRCUIT

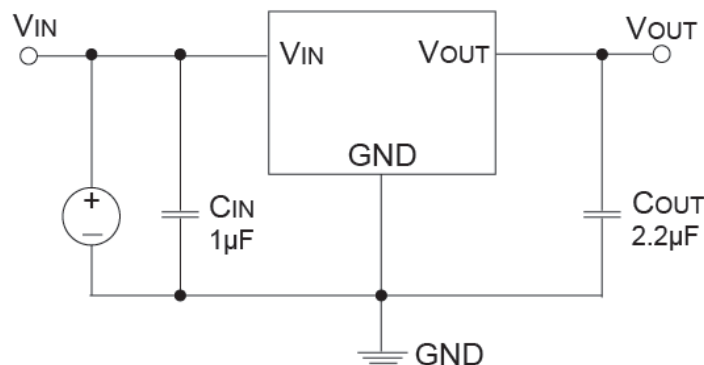

ABSOLUTE MAXIMUM RATINGS ($T_A = 25^\circ\text{C}$ unless otherwise noted) ^(Note 1)			
PARAMETER	SYMBOL	LIMIT	UNIT
Input Supply Voltage	V_{IN}	-20 ~ +20	V
Recommend Operating Input Voltage	V_{IN}	+2.5 ~ +16	V
Power Dissipation ^(Note 2)	P_D	Internal limited	
Output Current	I_O	80	mA
Junction to Ambient Thermal Resistance	SOT-23	220	°C/W
	SOT-89	180	
	DFN2x2	80	
Operating Junction Temperature Range	T_J	-40 ~ +125	°C
Storage Temperature Range	T_{STG}	-65 ~ +150	°C

Notes:

- Exceeding the absolute maximum rating may damage the device.
- The maximum allowable power dissipation at any T_A is $P_{D(MAX)} = [T_{J(MAX)} - T_a] + R_{\theta JA}$. Exceeding the maximum allowable power dissipation will result in excessive die temperature, and the regulator will go into thermal shutdown.

ELECTRICAL SPECIFICATIONS ($T_A = 25^\circ\text{C}$ unless otherwise noted)					
PARAMETER	CONDITIONS	MIN	TYP	MAX	UNIT
Output Voltage	$V_{IN} = V_O + 1V$	0.97 Vo	V_{OUT}	1.03 Vo	V
	$V_{IN} = V_O + 1V, I_O = 80mA$	0.96 Vo		1.04 Vo	
Output Voltage Temp. Coefficient ^(Note 3)		--	50	--	ppm/°C
Line Regulation	$V_O + 1V \leq V_{IN} \leq 16V$	--	0.1	0.5	%
Load Regulation ^(Note 4)	$0.1mA \leq I_O \leq 80mA$	--	1	2	%
Dropout Voltage ^(Note 6)	$I_O = 100\mu A$	--	20	--	mV
	$I_O = 50mA$	--	250	400	
	$I_O = 80mA$	--	300	600	
Ground Pin Current ^(Note 7)	$I_O = 100\mu A$	--	180	--	μA
	$I_O = 50mA$	--	850	1250	
	$I_O = 80mA$	--	2600	3100	
Output Current Limit	$V_{OUT} = 0V$	--	180	--	mA
Power Supply Rejection Ratio	At $f = 100Hz, I_O = 100\mu A$,	--	65	--	dB
Thermal Regulation ^(Note 8)		--	0.05	--	%/W
Output Noise	$I_O = 50mA,$ $C_{OUT} = 2.2\mu F,$	--	260	--	$nV\sqrt{Hz}$

Note:

- The device is not guaranteed to function outside its operating rating.
- Output voltage temperature coefficient is defined as the worst case voltage change divided by the total temperature range.
- Regulation is measured at constant junction temperature using low duty cycle pulse testing. Parts are tested for load regulation in the load range from 1mA to 80mA. Changes in output voltage due to heating effects are covered by the thermal regulation specification.
- Dropout voltage is defined as the input to output differential at which the output voltage drops 2% below its nominal value measured at 1V differential.
- Ground pin current is the regulator quiescent current plus pass transistor base current. The total current drawn from the supply is the sum of the load current plus the ground pin current.
- Thermal regulation is defined as the change in output voltage at a time "t" after a change in power dissipation is applied, excluding load or line regulation effects. Specifications are for 80mA load pulse at $V_{IN} = 16V$ for $t = 10ms$.

ORDERING INFORMATION

OUTPUT VOLTAGE	PART NO.	PACKAGE	PACKING
3.3V	TS5204CQ33 RFG	DFN2x2	3,000pcs / 7" Reel
	TS5204CX33 RFG	SOT-23	3,000pcs / 7" Reel
5V	TS5204CY50 RMG	SOT-89	1,000pcs / 7" Reel
	TS5204CX50 RFG	SOT-23	3,000pcs / 7" Reel

APPLICATION INFORMATION

TS5204 series is designed to provide 80mA of continuous current in a very small package. Maximum power dissipation can be calculated based on the output current and the voltage drop across the part. To determine the maximum power dissipation of the package, use the junction-ambient thermal resistance of the device and the following basic equation:

$$P_{D(MAX)} = [T_{J(MAX)} - T_A] / R_{\theta JA}$$

$T_{J(max)}$ is the maximum junction temperature of the die (125°C), and T_a is the ambient operating temperature. $R_{\theta JA}$ is layout dependent, the actual power dissipation of the regulator circuit can be determined using the equation:

$$P_D = (V_{IN} - V_{OUT}) * I_{OUT} + V_{IN} * I_{GND}$$

Substituting $P_{D(MAX)}$ for P_D and solving for the operating conditions that are critical to the application will give the maximum operating conditions for the regulator circuit. For example, when operating the TS5204CX33 at room temperature with a minimum footprint layout, the maximum input voltage for a set output current can be determined as follows:

$$P_{D(MAX)} = (125^{\circ}\text{C} - 25^{\circ}\text{C}) / 220^{\circ}\text{C/W}$$

The junction to ambient thermal resistance for the minimum footprint is 220°C/W, the maximum power dissipation must not be exceeded for proper operation. Using the output voltage of 3.3V and an output current of 80mA, the maximum input voltage can be determined. From the electrical characteristics table, the maximum ground current for 80mA output current is 2.5mA.

$$445\text{mW} = (V_{IN} - 3.3\text{V}) * 120\text{mA} + V_{IN} * 2.5\text{mA}$$

$$445\text{mW} = V_{IN} * 120\text{mA} - 3.3 * 120\text{mA} + V_{IN} * 2.5\text{mA}$$

$$445\text{mW} = V_{IN} * 120\text{mA} - 395\text{mW} + V_{IN} * 2.5\text{mA}$$

$$840\text{mW} = V_{IN} * 122.5\text{mA}$$

$$V_{IN} (\text{max}) = 6.85\text{V}$$

Therefore, a 3.3V application at 80mA of output current can accept a maximum input voltage of 6.85V in a SOT-23 package.

Input Capacitor Requirement

An input capacitor of 0.1µF or greater is recommended when the device is more than 10" away from the bulk AC supply capacitance or when the supply is a battery.

APPLICATION INFORMATION (CONTINUE)

Output Capacitor Requirement

The TS5204 series requires an output capacitor to maintain stability and improve transient response is necessary. 2.2µF minimum is recommended. Larger values improve the regulator’s transient response. The output capacitor value may be increased without limit.

The output capacitor should have an ESR (effective series resistance) less than 5Ω and a resonant frequency above 1MHz. Ultra-low ESR capacitors can cause a low amplitude oscillation on the output and/or under damped transient response. Most of tantalum or aluminum electrolytic capacitors are adequate; film types will work. Since many aluminum electrolytic have electrolytes that freeze at about -30°C, solid tantalums are recommended for operation below -25°C. At lower values of output current, less output capacitance is required for output stability. The capacitor can be reduced to 0.47µF for current below 10mA or 0.33µF for currents below 1mA.

No Load Stability

The TS5204 series will remain stable and in regulation with no load, unlike many other voltage regulators. This is especially important in CMOS RAM keep alive applications.

Dual Supply Operation

When used in dual supply systems where the regulator load is returned to a negative supply, the output voltage must be diode clamped to ground.

ELECTRICAL CHARACTERISTICS CURVES ($T_A=25^{\circ}C$, unless otherwise noted)

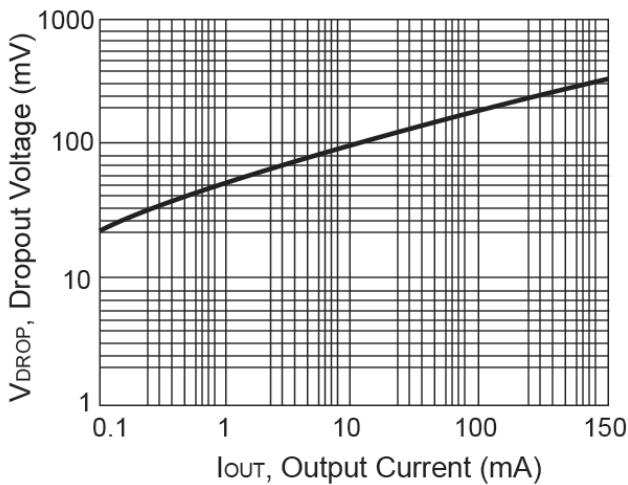

Figure 1. Dropout Voltage vs. Output Current

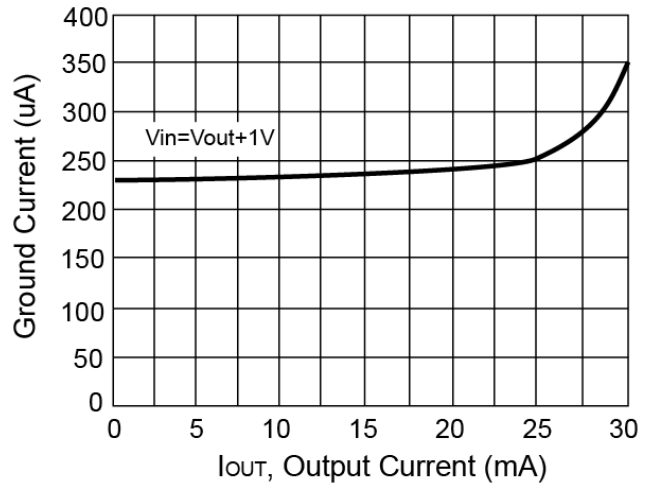

Figure 2. Ground Current vs. Output Current

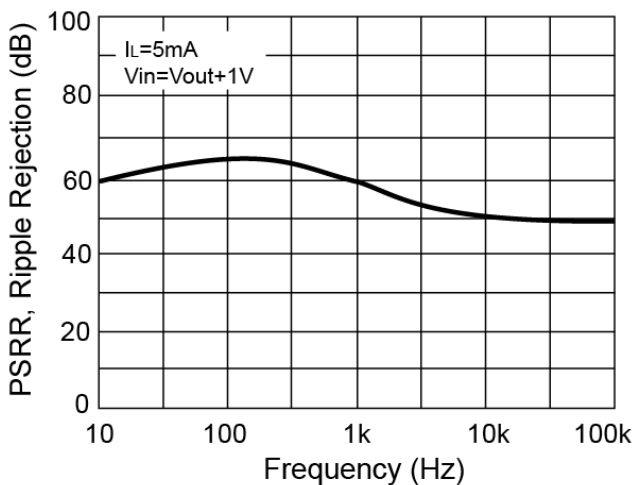

Figure 3. Dropout Voltage vs. Output Current

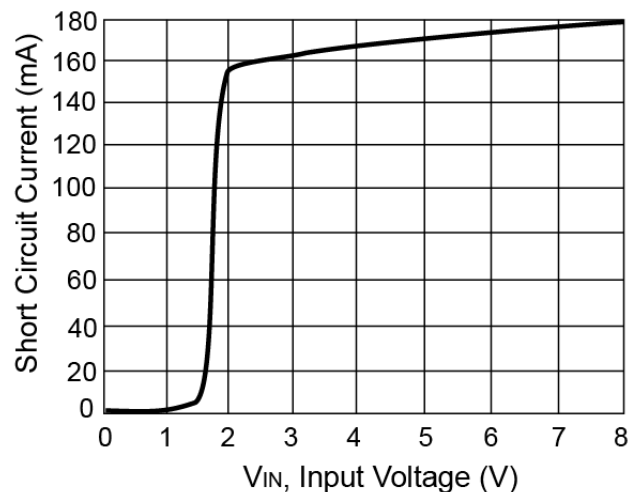
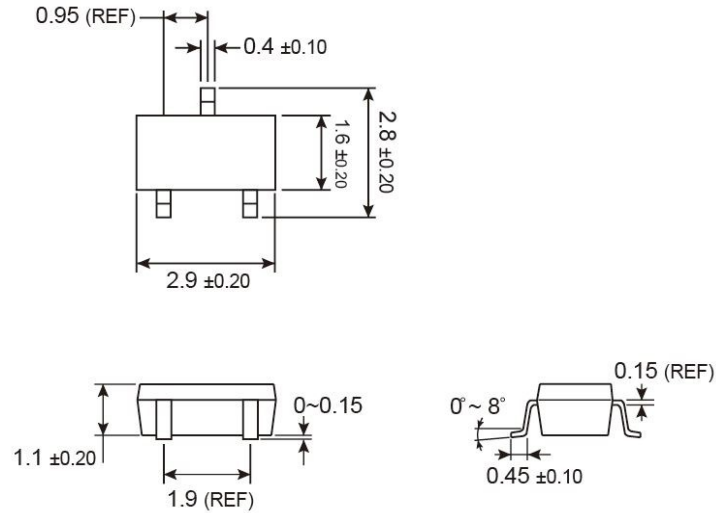

Figure 4. Short Circuit Current vs. Input Voltage

PACKAGE OUTLINE DIMENSIONS (Unit: Millimeters)

SOT-23



SUGGESTED PAD LAYOUT (Unit: Millimeters)

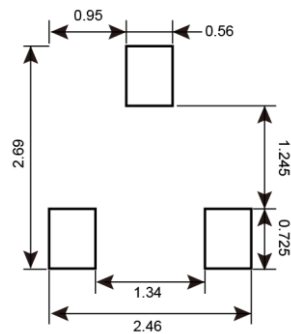

MARKING DIAGRAM

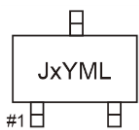

- J** = Device Code
- x** = Voltage Code
(**5** = 5.0V, **S** = 3.3V)
- Y** = Year Code
- M** = Month Code for Halogen Free Product
 - O** =Jan **P** =Feb **Q** =Mar **R** =Apr
 - S** =May **T** =Jun **U** =Jul **V** =Aug
 - W** =Sep **X** =Oct **Y** =Nov **Z** =Dec
- L** = Lot Code

PACKAGE OUTLINE DIMENSIONS (Unit: Millimeters)

SOT-89

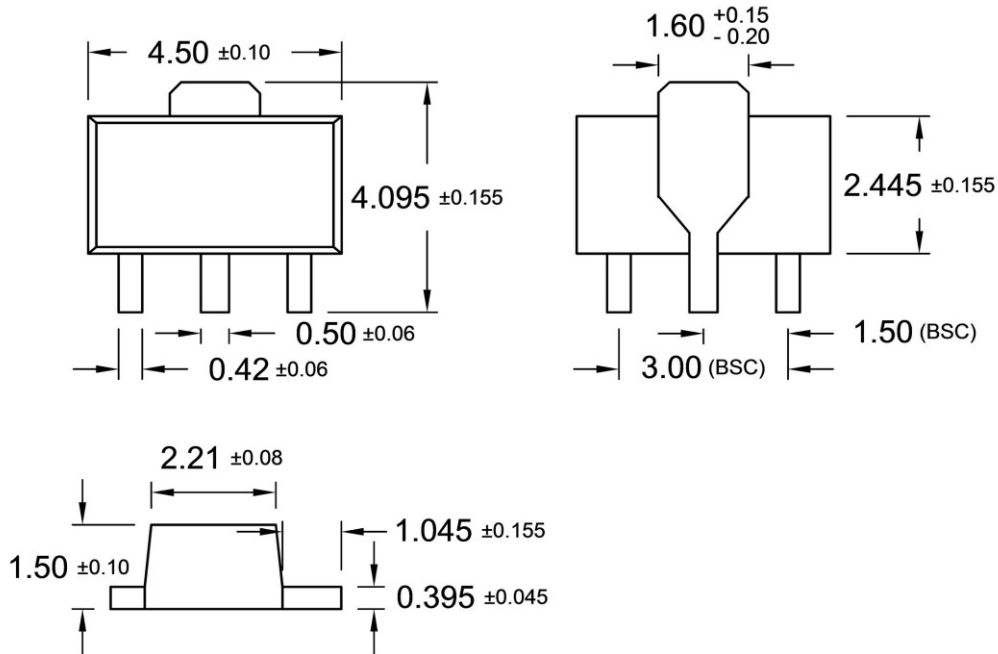

SUGGESTED PAD LAYOUT (Unit: Millimeters)

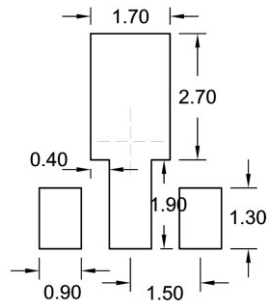

MARKING DIAGRAM

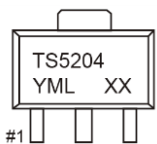

- Y** = Year Code
- M** = Month Code for Halogen Free Product
 - O** =Jan **P** =Feb **Q** =Mar **R** =Apr
 - S** =May **T** =Jun **U** =Jul **V** =Aug
 - W** =Sep **X** =Oct **Y** =Nov **Z** =Dec
- L** = Lot Code
- xx** = Voltage
(**50** = 5.0V)

PACKAGE OUTLINE DIMENSIONS (Unit: Millimeters)

DFN2x2

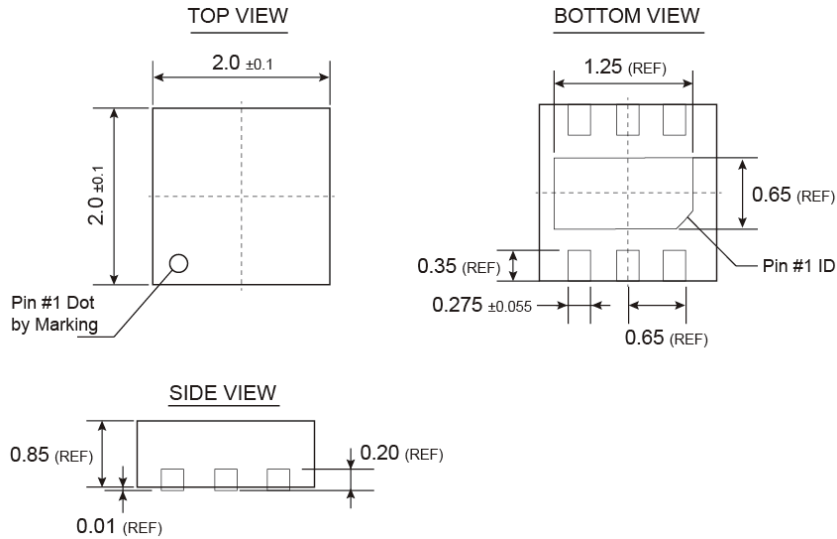

SUGGESTED PAD LAYOUT (Unit: Millimeters)

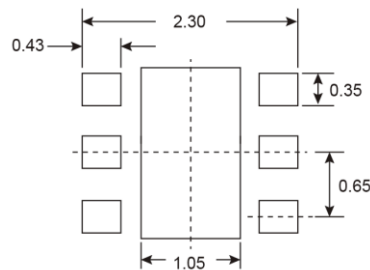

MARKING DIAGRAM



- J** = Device Code
- xx** = Fixed Output Voltage Code
(**33** = 3.3V)
- Y** = Year Code
- M** = Month Code for Halogen Free Product
 - O** =Jan **P** =Feb **Q** =Mar **R** =Apr
 - S** =May **T** =Jun **U** =Jul **V** =Aug
 - W** =Sep **X** =Oct **Y** =Nov **Z** =Dec
- L** = Lot Code

Notice

Specifications of the products displayed herein are subject to change without notice. TSC or anyone on its behalf, assumes no responsibility or liability for any errors or inaccuracies.

Purchasers are solely responsible for the choice, selection, and use of TSC products and TSC assumes no liability for application assistance or the design of Purchasers' products.

Information contained herein is intended to provide a product description only. No license, express or implied, to any intellectual property rights is granted by this document. Except as provided in TSC's terms and conditions of sale for such products, TSC assumes no liability whatsoever, and disclaims any express or implied warranty, relating to sale and/or use of TSC products including liability or warranties relating to fitness for a particular purpose, merchantability, or infringement of any patent, copyright, or other intellectual property right.

The products shown herein are not designed for use in medical, life-saving, or life-sustaining applications. Customers using or selling these products for use in such applications do so at their own risk and agree to fully indemnify TSC for any damages resulting from such improper use or sale.

Mouser Electronics

Authorized Distributor

Click to View Pricing, Inventory, Delivery & Lifecycle Information:

[Taiwan Semiconductor:](#)

[TS5204CX33](#) [TS5204CX50 RFG](#) [TS5204CY50](#) [TS5204CX33 RFG](#) [TS5204CY50 RMG](#) [TS5204CQ33 RFG](#)