

# SMD SHIELDED POWER INDUCTORS



ASPI-0428S



## FEATURES:

- Superior to be high saturation for surface mounting
- Very thin & compact
- With large permissible DC current & low DC resistance
- Magnetic shielding surface mount inductor with high rating

## APPLICATIONS:

- PDA's flash memory
- Step-up, step-down converters
- Communications
- Hard disk, notebook computer

## ELECTRICAL SPECIFICATIONS:

### PARAMETERS

ABRACON P/N: ASPI-0428S-XXX

Operating temperature: -40°C to +85°C

Storage temperature: -40°C to +85°C

Part#	Inductance (μH)	Tol. (%)	RDC max. (Ω)	IDC max. (A)
ASPI-0428S-1R2	1.2	M	0.0236	2.56
ASPI-0428S-1R8	1.8	M	0.0275	2.20
ASPI-0428S-2R2	2.2	M	0.0313	2.04
ASPI-0428S-2R7	2.7	M	0.0433	1.60
ASPI-0428S-3R3	3.3	M	0.0492	1.57
ASPI-0428S-3R9	3.9	M	0.0648	1.44
ASPI-0428S-4R7	4.7	M	0.0720	1.32
ASPI-0428S-5R6	5.6	M	0.1009	1.17
ASPI-0428S-6R8	6.8	M	0.1089	1.12
ASPI-0428S-8R2	8.2	M	0.1175	1.04
ASPI-0428S-100	10	M	0.1283	1.00
ASPI-0428S-120	12	M	0.1316	0.84
ASPI-0428S-150	15	M	0.1490	0.76
ASPI-0428S-180	18	M	0.1660	0.72
ASPI-0428S-220	22	M	0.2350	0.70
ASPI-0428S-270	27	M	0.2610	0.58
ASPI-0428S-330	33	M	0.3780	0.56
ASPI-0428S-390	39	M	0.3837	0.50
ASPI-0428S-470	47	M	0.5870	0.48
ASPI-0428S-560	56	M	0.6245	0.41
ASPI-0428S-680	68	M	0.6990	0.35
ASPI-0428S-820	82	M	0.9148	0.32
ASPI-0428S-101	100	M	1.0200	0.29
ASPI-0428S-121	120	M	1.2700	0.27
ASPI-0428S-151	150	M	1.3500	0.24
ASPI-0428S-181	180	M	1.5400	0.22

Note:

Test Frequency is 100KHz. DCR & IDC listed are all Max. value. Tolerance: M=±20%, M tolerance is standard

## OPTIONS AND PART IDENTIFICATION

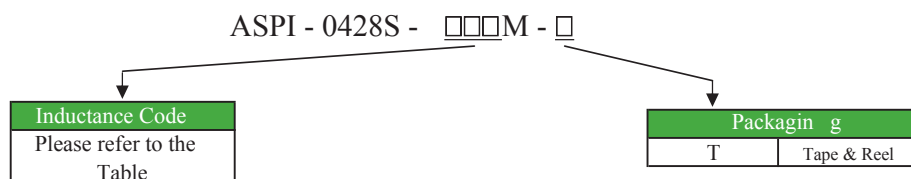

ABRACON IS  
ISO 9001:2008  
CERTIFIED



**ABRACON**  
CORPORATION

Visit [www.abracon.com](http://www.abracon.com) for Terms & Conditions of Sale **Revised: 01.11.11**  
30332 Esperanza, Rancho Santa Margarita, California 9268  
tel 949-546-8000 | fax 949-546-8001 | [www.abracon.com](http://www.abracon.com)

# SMD SHIELDED POWER INDUCTORS



**ASPI-0428S**

**Pb** | **RoHS**  
Compliant

➤ **DATA PLOT:**

**Inductance vs Frequency**

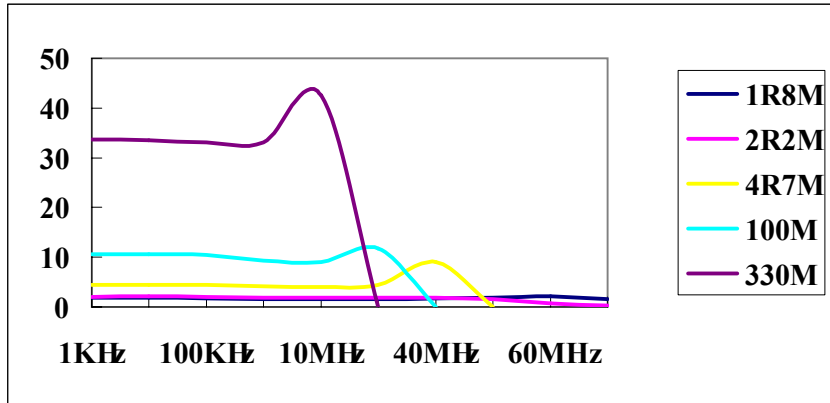

**Inductance vs Current**

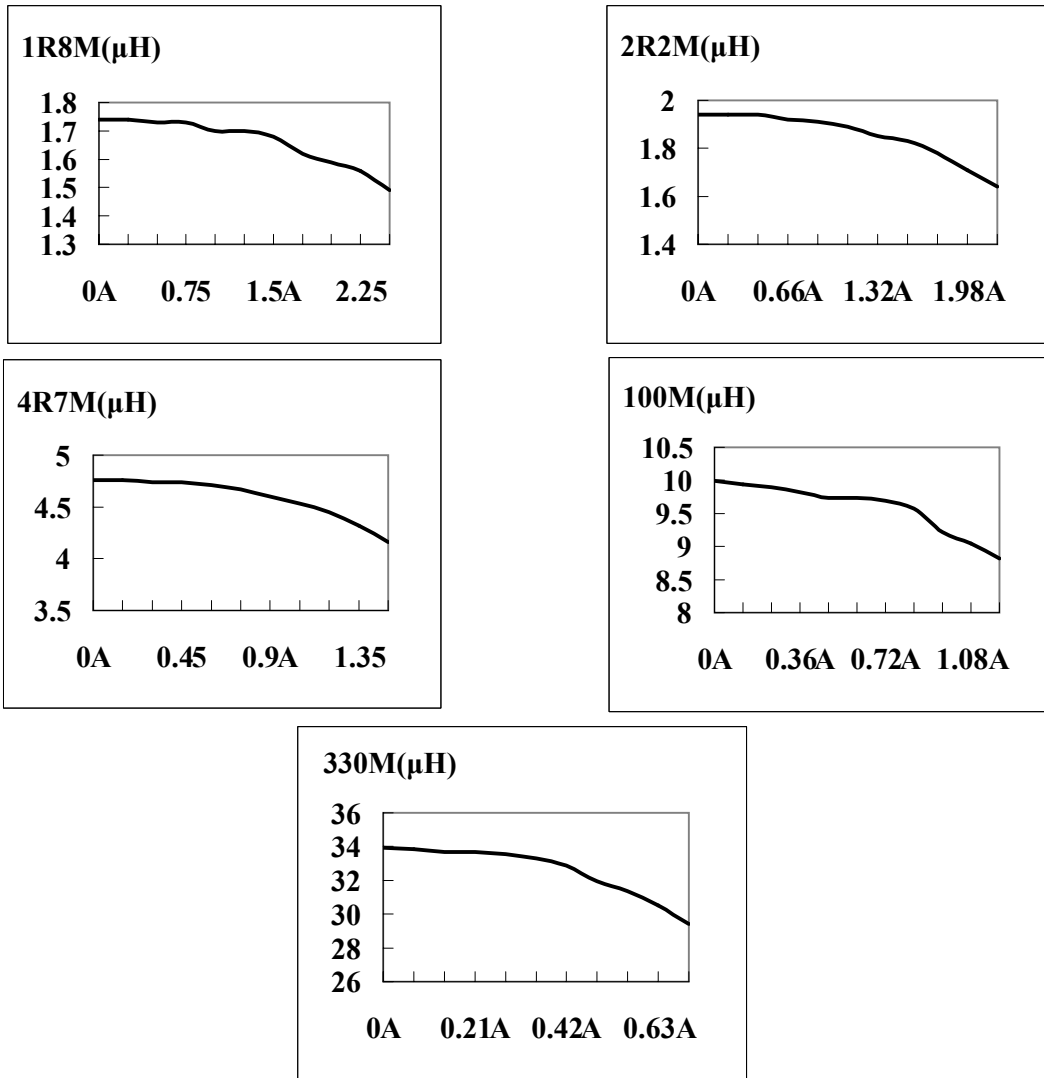

# SMD SHIELDED POWER INDUCTORS



**ASPI-0428S**



**RoHS**  
Compliant

## OUTLINE DRAWING:

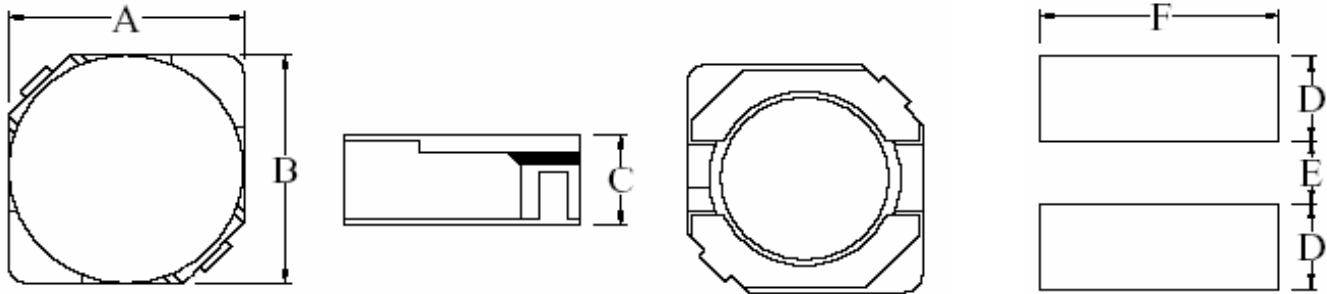

Part#	A	B	C	D	E	F
ASPI-0428S-xxx	0.185±0.012	0.185±0.012	0.118 Max	0.075 ref.	0.059 ref.	0.209 ref.
	(4.7± 0.3)	(4.7± 0.3)	(3.0) max.	(1.9) ref.	(1.5) ref.	(5.3) ref.

Dimension : Inches (mm)

## TAPE & REEL: Tape and reel 2,000pcs/reel

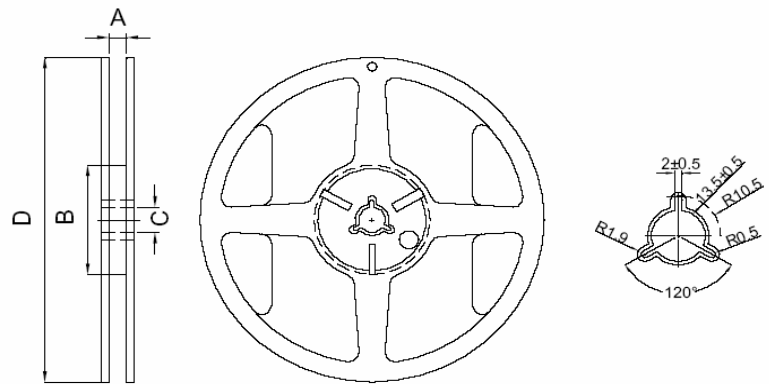
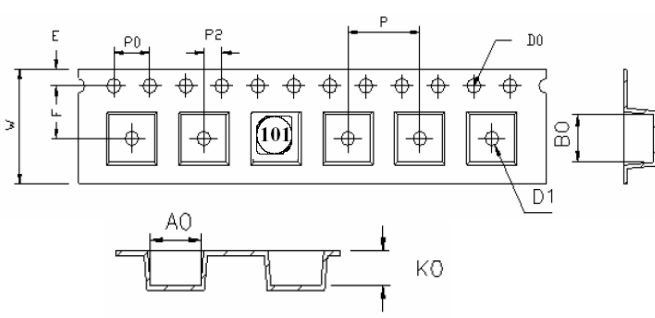

Part#	A0	B0	K0	P	P0	P2
ASPI-0428S-xxx	5.2± 0.1	5.2± 0.1	3.2± 0.1	8.0± 0.1	4.0± 0.1	2.0± 0.1
	W	F	E	D0	D1	
	12± 0.3,	5.5± 0.05	1.75±0.1	1.5 min.	1.5 min.	

Dimension : mm

Part#	A	B	C	D
ASPI-0428S-xxx	12.5± 0.5	100± 0.5	13.2± 0.3	330± 1.0

## REFLOW PROFILE:

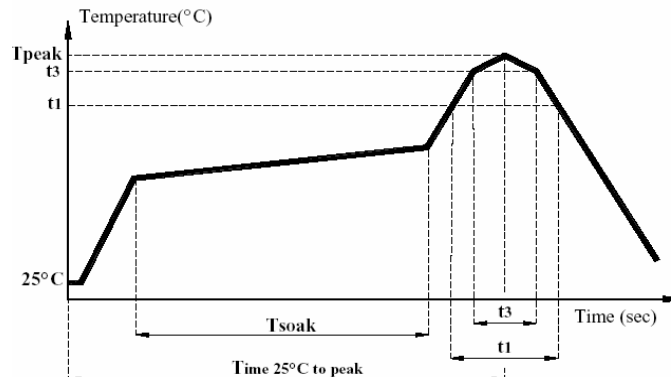

**ATTENTION:** Abracon Corporation's products are COTS – Commercial-Off-The-Shelf products; suitable for Commercial, Industrial and, where designated, Automotive Applications. Abracon's products are not specifically designed for Military, Aviation, Aerospace, Life-dependant Medical applications or any application requiring high reliability where component failure could result in loss of life and/or property. For applications requiring high reliability and/or presenting an extreme operating environment, written consent and authorization from Abracon Corporation is required. Please contact Abracon Corporation for more information.

ABRACON IS  
ISO 9001:2008  
CERTIFIED



**ABRACON**  
CORPORATION

Visit [www.abracon.com](http://www.abracon.com) for Terms & Conditions of Sale **Revised: 01.11.11**  
30332 Esperanza, Rancho Santa Margarita, California 9268  
tel 949-546-8000 | fax 949-546-8001 | [www.abracon.com](http://www.abracon.com)

# Mouser Electronics

Authorized Distributor

Click to View Pricing, Inventory, Delivery & Lifecycle Information:

## ABRACON:

[ASPI-0428S-100M-T](#) [ASPI-0428S-101M-T](#) [ASPI-0428S-120M-T](#) [ASPI-0428S-121M-T](#) [ASPI-0428S-150M-T](#) [ASPI-0428S-151M-T](#) [ASPI-0428S-180M-T](#) [ASPI-0428S-181M-T](#) [ASPI-0428S-1R2M-T](#) [ASPI-0428S-1R8M-T](#) [ASPI-0428S-220M-T](#) [ASPI-0428S-270M-T](#) [ASPI-0428S-2R2M-T](#) [ASPI-0428S-2R7M-T](#) [ASPI-0428S-330M-T](#) [ASPI-0428S-390M-T](#) [ASPI-0428S-3R3M-T](#) [ASPI-0428S-3R9M-T](#) [ASPI-0428S-470M-T](#) [ASPI-0428S-4R7M-T](#) [ASPI-0428S-560M-T](#) [ASPI-0428S-5R6M-T](#) [ASPI-0428S-680M-T](#) [ASPI-0428S-6R8M-T](#) [ASPI-0428S-820M-T](#) [ASPI-0428S-8R2M-T](#)