

# IRF7832PbF

HEXFET® Power MOSFET

## Applications

- Synchronous MOSFET for Notebook Processor Power
- Synchronous Rectifier MOSFET for Isolated DC-DC Converters in Networking Systems
- Lead-Free

## Benefits

- Very Low  $R_{DS(on)}$  at 4.5V  $V_{GS}$
- Ultra-Low Gate Impedance
- Fully Characterized Avalanche Voltage and Current
- 20V  $V_{GS}$  Max. Gate Rating
- 100% tested for Rg

$V_{DSS}$	$R_{DS(on)}$ max	Qg
30V	4.0m $\Omega$ @ $V_{GS} = 10V$	34nC

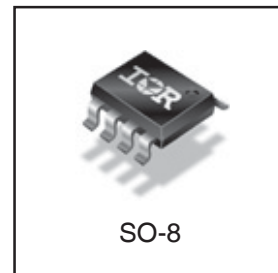
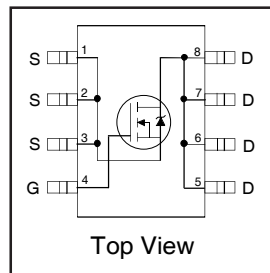

## Absolute Maximum Ratings

	Parameter	Max.	Units
$V_{DS}$	Drain-to-Source Voltage	30	V
$V_{GS}$	Gate-to-Source Voltage	$\pm 20$	
$I_D @ T_A = 25^\circ C$	Continuous Drain Current, $V_{GS} @ 10V$	20	A
$I_D @ T_A = 70^\circ C$	Continuous Drain Current, $V_{GS} @ 10V$	16	
$I_{DM}$	Pulsed Drain Current ①	160	
$P_D @ T_A = 25^\circ C$	Power Dissipation	2.5	W
$P_D @ T_A = 70^\circ C$	Power Dissipation	1.6	
	Linear Derating Factor	0.02	W/ $^\circ C$
$T_J$	Operating Junction and	-55 to + 155	$^\circ C$
$T_{STG}$	Storage Temperature Range		

## Thermal Resistance

	Parameter	Typ.	Max.	Units
$R_{\theta JL}$	Junction-to-Drain Lead	—	20	$^\circ C/W$
$R_{\theta JA}$	Junction-to-Ambient ②	—	50	

Notes ① through ④ are on page 10

www.irf.com

## Static @ T<sub>J</sub> = 25°C (unless otherwise specified)

	Parameter	Min.	Typ.	Max.	Units	Conditions
BV <sub>DSS</sub>	Drain-to-Source Breakdown Voltage	30	—	—	V	V <sub>GS</sub> = 0V, I <sub>D</sub> = 250μA
ΔBV <sub>DSS</sub> /ΔT <sub>J</sub>	Breakdown Voltage Temp. Coefficient	—	0.023	—	V/°C	Reference to 25°C, I <sub>D</sub> = 1mA
R <sub>DS(on)</sub>	Static Drain-to-Source On-Resistance	—	3.1	4.0	mΩ	V <sub>GS</sub> = 10V, I <sub>D</sub> = 20A ③
		—	3.7	4.8		V <sub>GS</sub> = 4.5V, I <sub>D</sub> = 16A ③
V <sub>GS(th)</sub>	Gate Threshold Voltage	1.39	—	2.32	V	V <sub>DS</sub> = V <sub>GS</sub> , I <sub>D</sub> = 250μA
ΔV <sub>GS(th)</sub>	Gate Threshold Voltage Coefficient	—	5.7	—	mV/°C	
I <sub>DSS</sub>	Drain-to-Source Leakage Current	—	—	1.0	μA	V <sub>DS</sub> = 24V, V <sub>GS</sub> = 0V
		—	—	150		V <sub>DS</sub> = 24V, V <sub>GS</sub> = 0V, T <sub>J</sub> = 125°C
I <sub>GSS</sub>	Gate-to-Source Forward Leakage	—	—	100	nA	V <sub>GS</sub> = 20V
	Gate-to-Source Reverse Leakage	—	—	-100		V <sub>GS</sub> = -20V
g <sub>fs</sub>	Forward Transconductance	77	—	—	S	V <sub>DS</sub> = 15V, I <sub>D</sub> = 16A
Q <sub>g</sub>	Total Gate Charge	—	34	51	nC	V <sub>DS</sub> = 15V V <sub>GS</sub> = 4.5V I <sub>D</sub> = 16A See Fig. 16
Q <sub>gs1</sub>	Pre-V <sub>th</sub> Gate-to-Source Charge	—	8.6	—		
Q <sub>gs2</sub>	Post-V <sub>th</sub> Gate-to-Source Charge	—	2.9	—		
Q <sub>gd</sub>	Gate-to-Drain Charge	—	12	—		
Q <sub>godr</sub>	Gate Charge Overdrive	—	10.5	—		
Q <sub>sw</sub>	Switch Charge (Q <sub>gs2</sub> + Q <sub>gd</sub> )	—	14.9	—		
Q <sub>oss</sub>	Output Charge	—	23	—	nC	V <sub>DS</sub> = 16V, V <sub>GS</sub> = 0V
R <sub>g</sub>	Gate Resistance	—	1.2	2.4	Ω	
t <sub>d(on)</sub>	Turn-On Delay Time	—	12	—	ns	V <sub>DD</sub> = 15V, V <sub>GS</sub> = 4.5V I <sub>D</sub> = 16A Clamped Inductive Load
t <sub>r</sub>	Rise Time	—	6.7	—		
t <sub>d(off)</sub>	Turn-Off Delay Time	—	21	—		
t <sub>f</sub>	Fall Time	—	13	—		
C <sub>iss</sub>	Input Capacitance	—	4310	—	pF	V <sub>GS</sub> = 0V V <sub>DS</sub> = 15V f = 1.0MHz
C <sub>oss</sub>	Output Capacitance	—	990	—		
C <sub>rss</sub>	Reverse Transfer Capacitance	—	450	—		

## Avalanche Characteristics

	Parameter	Typ.	Max.	Units
E <sub>AS</sub>	Single Pulse Avalanche Energy ②	—	260	mJ
I <sub>AR</sub>	Avalanche Current ①	—	16	A

## Diode Characteristics

	Parameter	Min.	Typ.	Max.	Units	Conditions
I <sub>S</sub>	Continuous Source Current (Body Diode)	—	—	3.1	A	MOSFET symbol showing the integral reverse p-n junction diode.
I <sub>SM</sub>	Pulsed Source Current (Body Diode) ①	—	—	160		
V <sub>SD</sub>	Diode Forward Voltage	—	—	1.0	V	T <sub>J</sub> = 25°C, I <sub>S</sub> = 16A, V <sub>GS</sub> = 0V ③
t <sub>rr</sub>	Reverse Recovery Time	—	41	62	ns	T <sub>J</sub> = 25°C, I <sub>F</sub> = 16A, V <sub>DD</sub> = 10V
Q <sub>rr</sub>	Reverse Recovery Charge	—	39	59	nC	di/dt = 100A/μs ③
t <sub>on</sub>	Forward Turn-On Time	Intrinsic turn-on time is negligible (turn-on is dominated by LS+LD)				

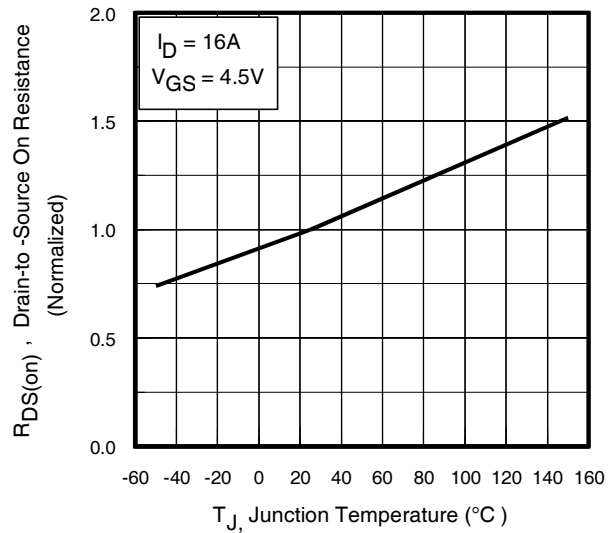
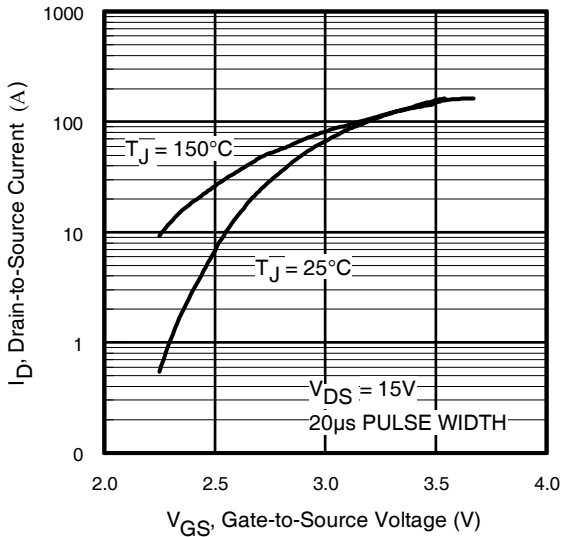
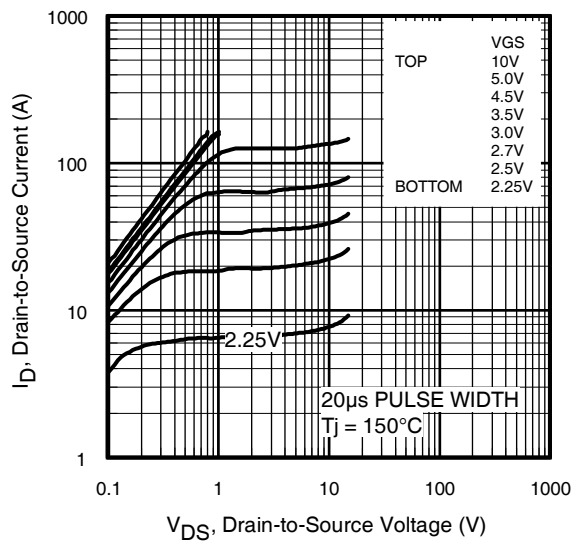
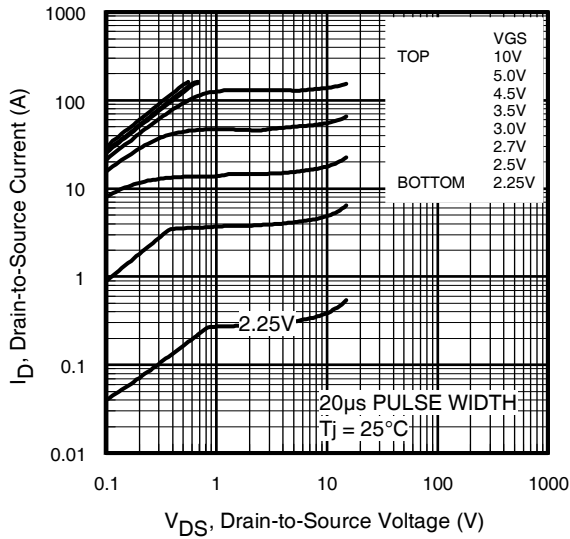

# IRF7832PbF

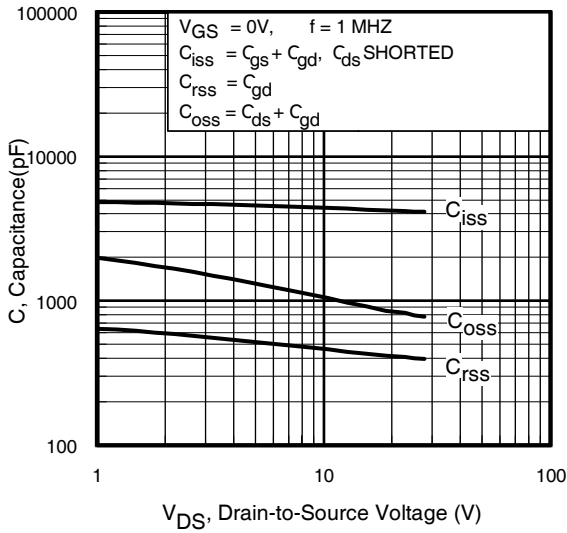

**Fig 5.** Typical Capacitance Vs. Drain-to-Source Voltage

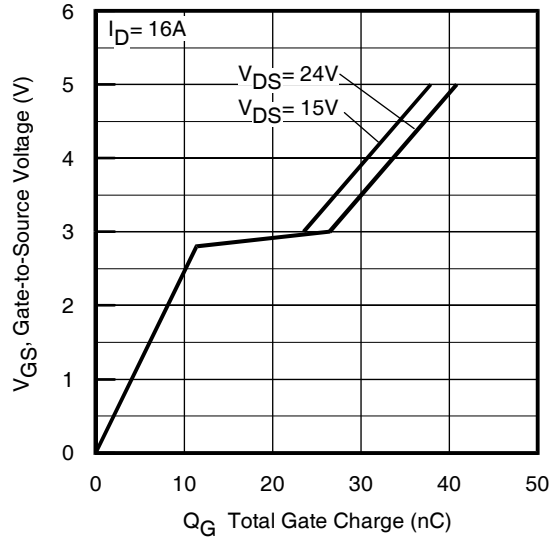

**Fig 6.** Typical Gate Charge Vs. Gate-to-Source Voltage

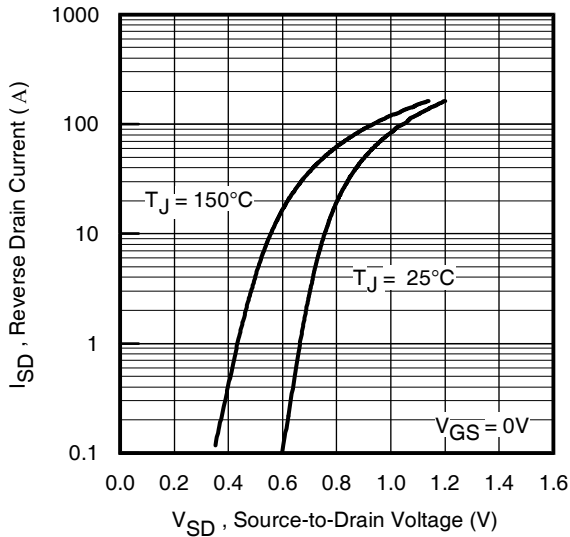

**Fig 7.** Typical Source-Drain Diode Forward Voltage

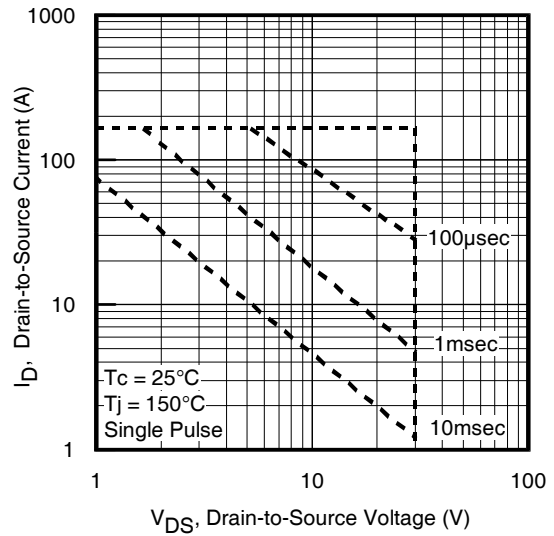

**Fig 8.** Maximum Safe Operating Area

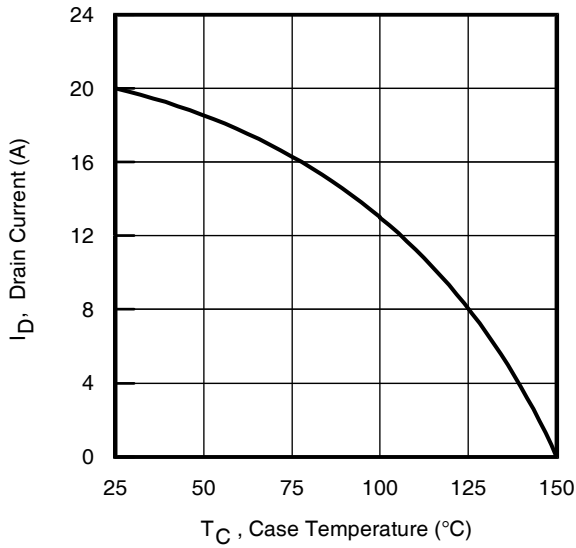

**Fig 9.** Maximum Drain Current Vs. Case Temperature

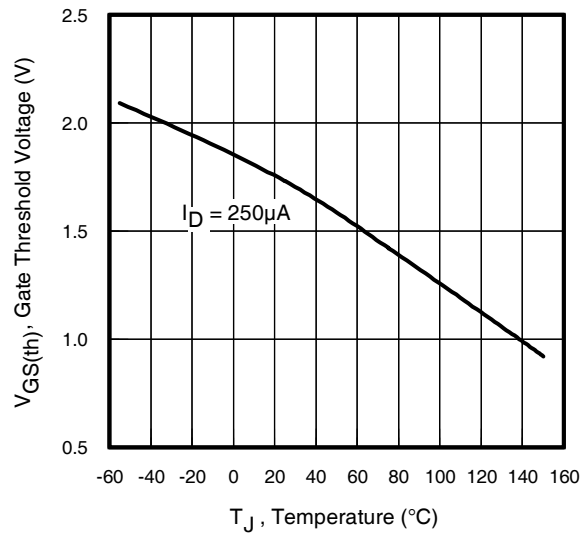

**Fig 10.** Threshold Voltage Vs. Temperature

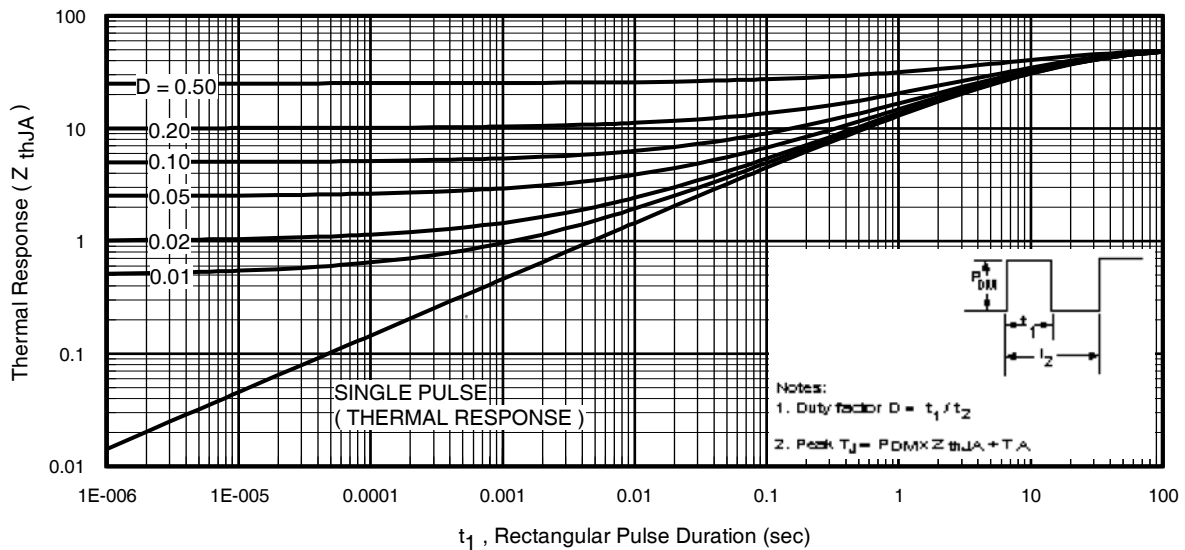

**Fig 11.** Maximum Effective Transient Thermal Impedance, Junction-to-Ambient

# IRF7832PbF

International  
**IR** Rectifier

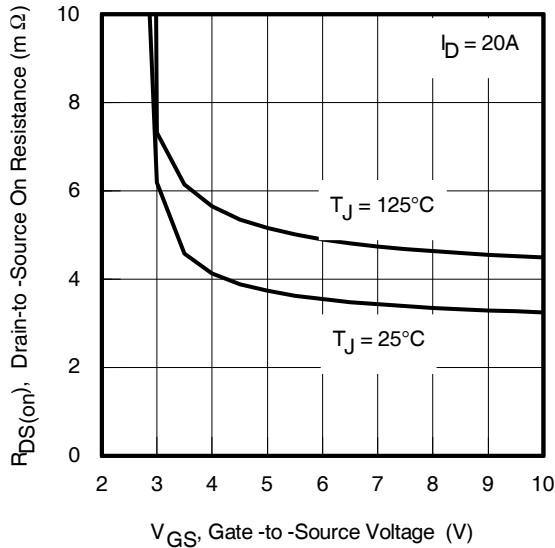

**Fig 12.** On-Resistance vs. Gate Voltage

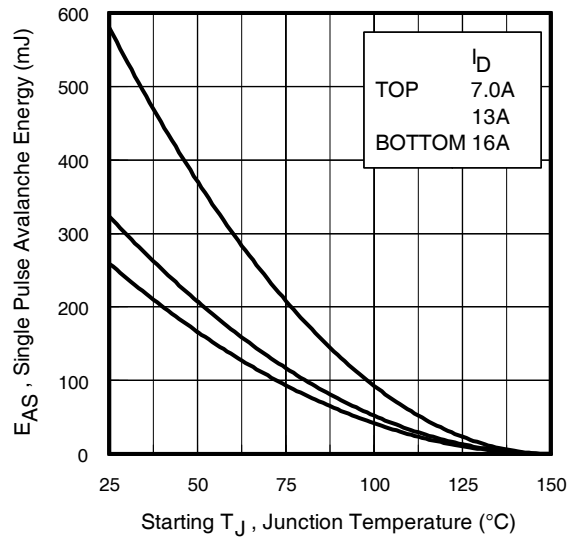

**Fig 13.** Maximum Avalanche Energy vs. Drain Current

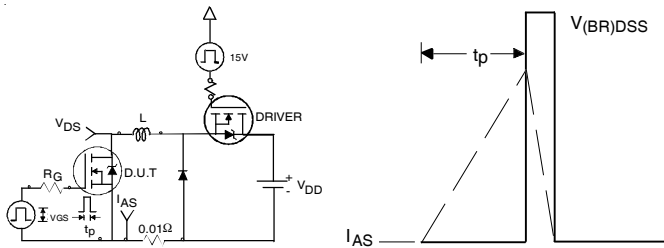

**Fig 14.** Unclamped Inductive Test Circuit and Waveform

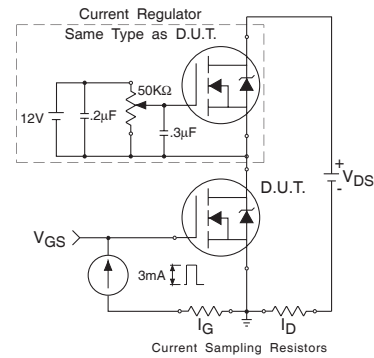

**Fig 15.** Gate Charge Test Circuit

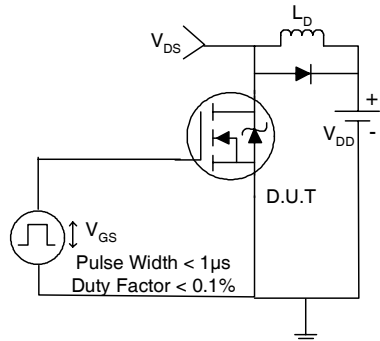

**Fig 16.** Switching Time Test Circuit

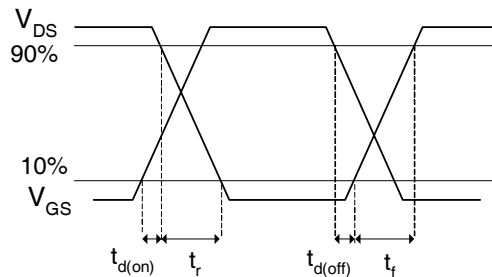

**Fig 17.** Switching Time Waveforms

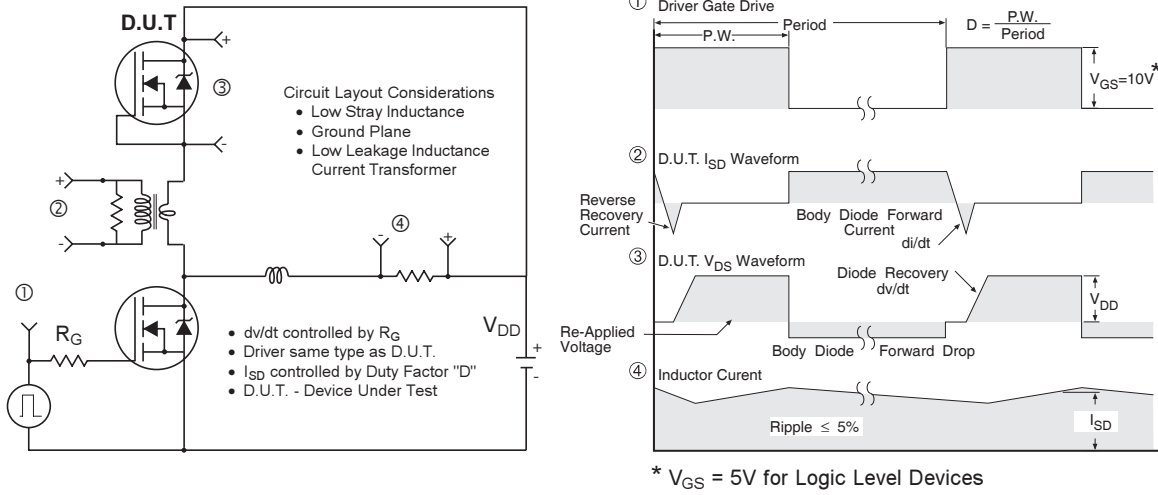

**Fig 18. Peak Diode Recovery  $dv/dt$  Test Circuit for N-Channel HEXFET® Power MOSFETS**



**Fig 19. Gate Charge Waveform**

## Power MOSFET Selection for Non-Isolated DC/DC Converters

### Control FET

Special attention has been given to the power losses in the switching elements of the circuit - Q1 and Q2. Power losses in the high side switch Q1, also called the Control FET, are impacted by the  $R_{ds(on)}$  of the MOSFET, but these conduction losses are only about one half of the total losses.

Power losses in the control switch Q1 are given by;

$$P_{loss} = P_{conduction} + P_{switching} + P_{drive} + P_{output}$$

This can be expanded and approximated by;

$$P_{loss} = (I_{rms}^2 \times R_{ds(on)}) + \left( I \times \frac{Q_{gd}}{i_g} \times V_{in} \times f \right) + \left( I \times \frac{Q_{gs2}}{i_g} \times V_{in} \times f \right) + (Q_g \times V_g \times f) + \left( \frac{Q_{oss}}{2} \times V_{in} \times f \right)$$

This simplified loss equation includes the terms  $Q_{gs2}$  and  $Q_{oss}$  which are new to Power MOSFET data sheets.

$Q_{gs2}$  is a sub element of traditional gate-source charge that is included in all MOSFET data sheets. The importance of splitting this gate-source charge into two sub elements,  $Q_{gs1}$  and  $Q_{gs2}$ , can be seen from Fig 16.

$Q_{gs2}$  indicates the charge that must be supplied by the gate driver between the time that the threshold voltage has been reached and the time the drain current rises to  $I_{dmax}$  at which time the drain voltage begins to change. Minimizing  $Q_{gs2}$  is a critical factor in reducing switching losses in Q1.

$Q_{oss}$  is the charge that must be supplied to the output capacitance of the MOSFET during every switching cycle. Figure A shows how  $Q_{oss}$  is formed by the parallel combination of the voltage dependant (non-linear) capacitance's  $C_{ds}$  and  $C_{dg}$  when multiplied by the power supply input buss voltage.

### Synchronous FET

The power loss equation for Q2 is approximated by;

$$P_{loss} = P_{conduction} + P_{drive} + P_{output}^*$$

$$P_{loss} = (I_{rms}^2 \times R_{ds(on)}) + (Q_g \times V_g \times f) + \left( \frac{Q_{oss}}{2} \times V_{in} \times f \right) + (Q_{rr} \times V_{in} \times f)$$

\*dissipated primarily in Q1.

For the synchronous MOSFET Q2,  $R_{ds(on)}$  is an important characteristic; however, once again the importance of gate charge must not be overlooked since it impacts three critical areas. Under light load the control IC so the gate drive losses become much more significant. Secondly, the output charge  $Q_{oss}$  and reverse recovery charge  $Q_{rr}$  both generate losses that are transferred to Q1 and increase the dissipation in that device. Thirdly, gate charge will impact the MOSFETs' susceptibility to Cdv/dt turn on.

The drain of Q2 is connected to the switching node of the converter and therefore sees transitions between ground and  $V_{in}$ . As Q1 turns on and off there is a rate of change of drain voltage dV/dt which is capacitively coupled to the gate of Q2 and can induce a voltage spike on the gate that is sufficient to turn the MOSFET on, resulting in shoot-through current. The ratio of  $Q_{gd}/Q_{gs1}$  must be minimized to reduce the potential for Cdv/dt turn on.



Figure A:  $Q_{oss}$  Characteristic



## SO-8 Package Details

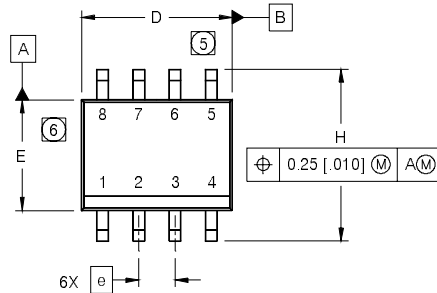

DIM	INCHES		MILLIMETERS	
	MIN	MAX	MIN	MAX
A	.0532	.0688	1.35	1.75
A1	.0040	.0098	0.10	0.25
b	.013	.020	0.33	0.51
c	.0075	.0098	0.19	0.25
D	.189	.1968	4.80	5.00
E	.1497	.1574	3.80	4.00
e	.050 BASIC		1.27 BASIC	
e1	.025 BASIC		0.635 BASIC	
H	.2284	.2440	5.80	6.20
K	.0099	.0196	0.25	0.50
L	.016	.050	0.40	1.27
y	0°	8°	0°	8°

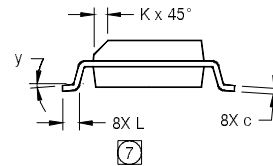
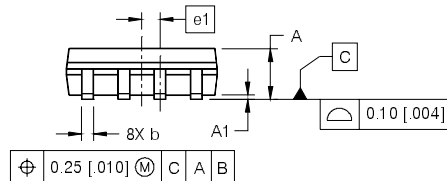

- NOTES:
- DIMENSIONING & TOLERANCING PER ASME Y14.5M-1994.
  - CONTROLLING DIMENSION: MILLIMETER
  - DIMENSIONS ARE SHOWN IN MILLIMETERS [INCHES].
  - OUTLINE CONFORMS TO JEDEC OUTLINE MS-012AA.
  - DIMENSION DOES NOT INCLUDE MOLD PROTRUSIONS. MOLD PROTRUSIONS NOT TO EXCEED 0.15 [0.006].
  - DIMENSION DOES NOT INCLUDE MOLD PROTRUSIONS. MOLD PROTRUSIONS NOT TO EXCEED 0.25 [0.010].
  - DIMENSION IS THE LENGTH OF LEAD FOR SOLDERING TO A SUBSTRATE.

### FOOTPRINT

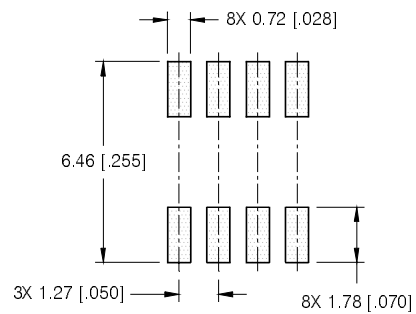

## SO-8 Part Marking

EXAMPLE: THIS IS AN IRF7807D1 (FETKY)

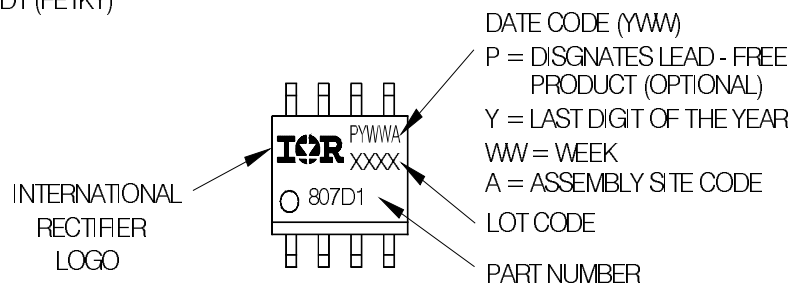

# IRF7832PbF

## SO-8 Tape and Reel

International  
**IR** Rectifier

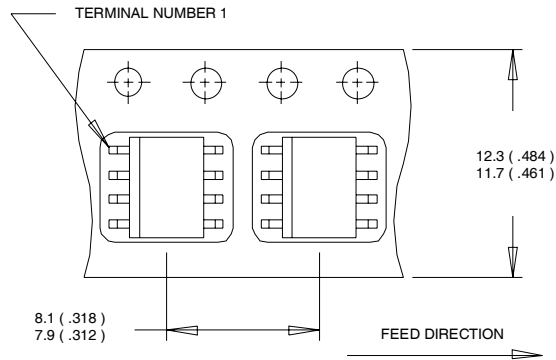

- NOTES:
1. CONTROLLING DIMENSION : MILLIMETER.
  2. ALL DIMENSIONS ARE SHOWN IN MILLIMETERS(INCHES).
  3. OUTLINE CONFORMS TO EIA-481 & EIA-541.

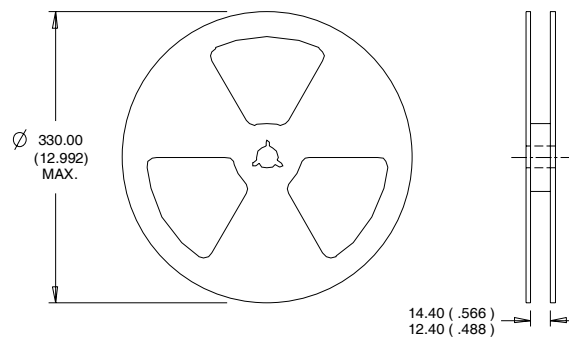

- NOTES :
1. CONTROLLING DIMENSION : MILLIMETER.
  2. OUTLINE CONFORMS TO EIA-481 & EIA-541.

### Notes:

- ① Repetitive rating; pulse width limited by max. junction temperature.
- ② Starting  $T_J = 25^\circ\text{C}$ ,  $L = 2.0\text{mH}$ ,  $R_G = 25\Omega$ ,  $I_{AS} = 16\text{A}$ .
- ③ Pulse width  $\leq 400\mu\text{s}$ ; duty cycle  $\leq 2\%$ .
- ④ When mounted on 1 inch square copper board.

Data and specifications subject to change without notice.  
This product has been designed and qualified for the Consumer market.  
Qualification Standards can be found on IR's Web site.

International  
**IR** Rectifier

IR WORLD HEADQUARTERS: 233 Kansas St., El Segundo, California 90245, USA Tel: (310) 252-7105  
TAC Fax: (310) 252-7903

Visit us at [www.irf.com](http://www.irf.com) for sales contact information.06/05  
[www.irf.com](http://www.irf.com)

## **IMPORTANT NOTICE**

The information given in this document shall in no event be regarded as a guarantee of conditions or characteristics ("Beschaffheitsgarantie").

With respect to any examples, hints or any typical values stated herein and/or any information regarding the application of the product, Infineon Technologies hereby disclaims any and all warranties and liabilities of any kind, including without limitation warranties of non-infringement of intellectual property rights of any third party.

In addition, any information given in this document is subject to customer's compliance with its obligations stated in this document and any applicable legal requirements, norms and standards concerning customer's products and any use of the product of Infineon Technologies in customer's applications.

The data contained in this document is exclusively intended for technically trained staff. It is the responsibility of customer's technical departments to evaluate the suitability of the product for the intended application and the completeness of the product information given in this document with respect to such application.

For further information on the product, technology, delivery terms and conditions and prices please contact your nearest Infineon Technologies office ([www.infineon.com](http://www.infineon.com)).

## **WARNINGS**

Due to technical requirements products may contain dangerous substances. For information on the types in question please contact your nearest Infineon Technologies office.

Except as otherwise explicitly approved by Infineon Technologies in a written document signed by authorized representatives of Infineon Technologies, Infineon Technologies' products may not be used in any applications where a failure of the product or any consequences of the use thereof can reasonably be expected to result in personal injury.

# Mouser Electronics

Authorized Distributor

Click to View Pricing, Inventory, Delivery & Lifecycle Information:

[Infineon:](#)

[IRF7832TRPBF](#)