

# OA4715 'Challenger Series'

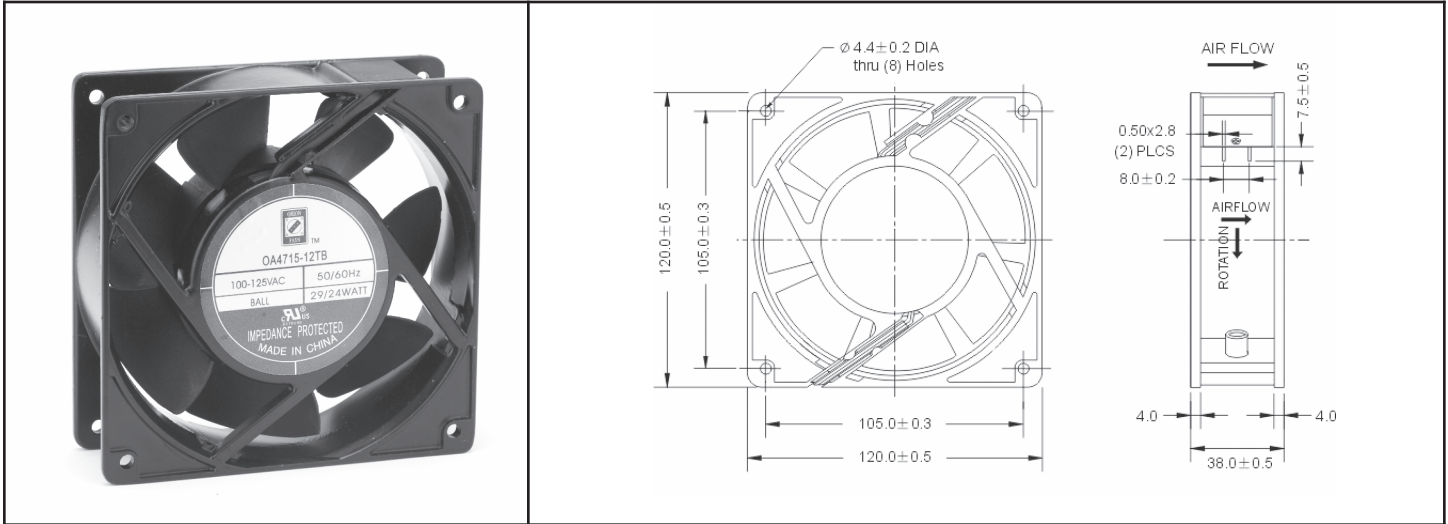

AC Fan - 115V, 230V  
120x38mm (4.7"x 1.5")



Frame	Diecast Aluminum	<u>Operating Temperature</u> Ball Bearing -10C ~ +70C Storage Temp -20C ~ +80C  <u>Life Expectancy</u> Ball Bearing 60,000 hours (L10 at 40C)  Weight: ~1.2 lbs.	
Impeller	PBT, UL94V-0 plastic		
Connection	Terminals		
Motor	AC shaded pole, impedance protected		
Bearing System	Dual ball		
Insulation Resistance	>100M ohm between lead-wire and frame (500VDC)		
Dielectric Strength	1 min at 1500 VAC, 50/60Hz		

Part Number	OA4715-12TB	OA4715-23TB
Nominal Voltage	115 VAC	230 VAC
Nominal Current	0.30 A	0.20 A
Rated Power	24 W (60Hz)	24 W (60Hz)
Rated Speed (RPM)	3000	3000
Airflow (CFM)	110	110
Noise Level (dB)	44	44
Max. Static Pressure	0.37" H <sub>2</sub> O	0.37" H <sub>2</sub> O