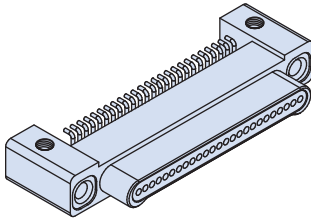
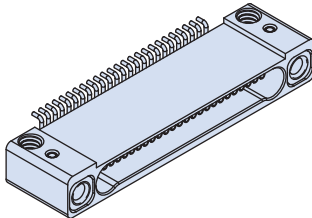

Right Angle SMT PCB Nano Connectors feature gold alloy TwistPin contacts. These nanominiature connectors offer premium performance and reliability for demanding applications. Available with #0-80 female threads.

Pre-Tinned PC Tails are coated with Sn60Pb40 or Sn63Pb37 tin-lead for excellent solderability.

Choose Aluminum, Titanium or Stainless Steel Shells in eight layouts from 5 to 51 contacts. Complies to the requirements of MIL-DTL-32139. These connectors are intermateable with any corresponding Glenair Series 890 single row metal shell nanominiature connector.

How to Order						
Sample Part Number		890-012	-25P	A2	-BRS	T
Series	890-012 = Plug, Pin Contacts, Single Row, Right Angle SMT Nanominiature 890-013 = Receptacle, Socket Contacts, Single Row, Right Angle SMT Nanominiature					
Insert Arrangement/Contact Type	Plugs (890-012): 5P, 9P, 15P, 21P, 25P, 31P, 37P, 51P Receptacles (890-013): 5S, 9S, 15S, 21S, 25S, 31S, 37S, 51S					
Shell Material and Finish	A1 = Aluminum Shell, Cadmium Plating A2 = Aluminum Shell, Electroless Nickel Plating		T = Titanium Shell, Unplated S = Stainless Steel Shell, Passivated			
Termination Type	BRS = Board Right Angle Surface Mount					
Hardware	T = Female Thread, #0-80					

Plug (Pin) Connector	Receptacle (Socket) Connector
	
T - Female Thread	T - Female Thread

NOTES

- Material and finish:
 - Shell: see part number breakdown
 - Insulator: LCP N/A
 - Contacts: Gold alloy per ASTM B477 and ASTM B541
 - Pre-tinned PC tails: coated with Sn63Pb37 or Sn60Pb40 tin-lead
 - Hardware: stainless steel, passivated
- Inspect and Test IAW MIL-DTL-32139
- Interface dimensions per MIL-DTL-32139/1 and MIL-DTL-32139/2

DETAIL A

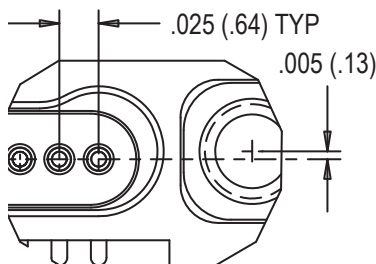

DETAIL B

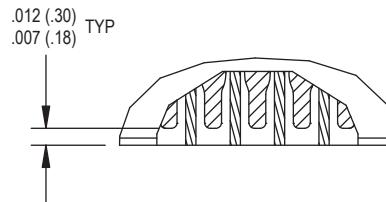

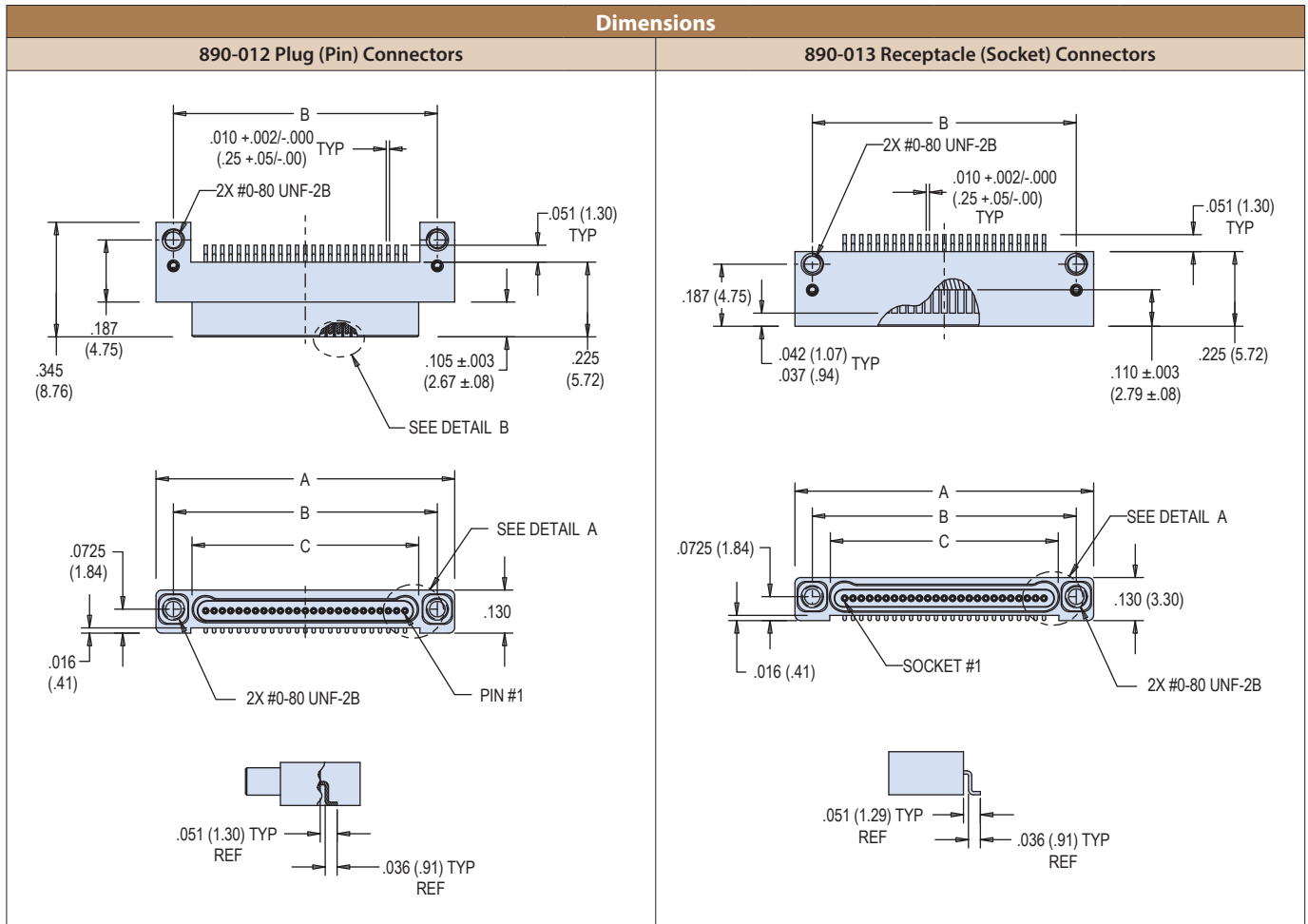

Layout	A		B BSC.		C BSC.	
	In. ± .005	mm. ± 0.13	In.	mm.	In.	mm.
5P	.400	10.16	.295	7.49	.184	4.67
5S	.400	10.16	.295	7.49	.185	4.70
9P	.500	12.70	.395	10.03	.284	7.21
9S	.500	12.70	.395	10.03	.285	7.24
15P	.650	16.51	.545	13.84	.434	11.02
15S	.650	16.51	.545	13.84	.435	11.05
21P	.800	20.32	.695	17.65	.584	14.83
21S	.800	20.32	.695	17.65	.585	14.86
25P	.900	22.86	.795	20.19	.684	17.37
25S	.900	22.86	.795	20.19	.685	17.40
31P	1.050	26.67	.945	24.00	.834	21.18
31S	1.050	26.67	.945	24.00	.835	21.21
37P	1.200	30.48	1.095	27.81	.984	24.99
37S	1.200	30.48	1.095	27.81	.985	25.02
51P	1.550	39.37	1.445	36.70	1.334	33.88
51S	1.550	39.37	1.445	36.70	1.335	33.91

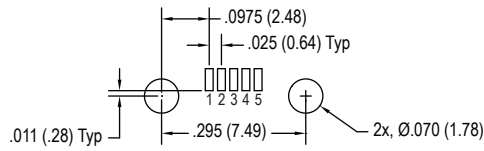

5 Contacts

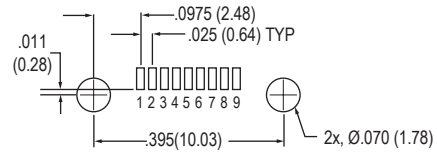

9 Contacts

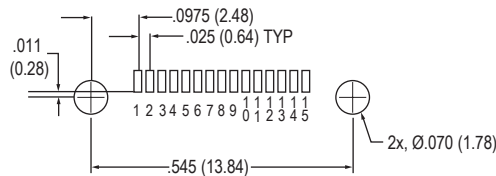

15 Contacts

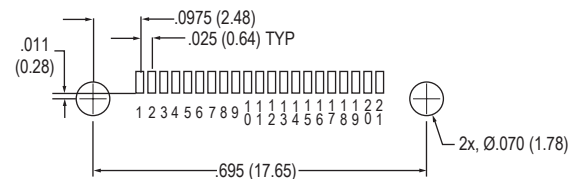
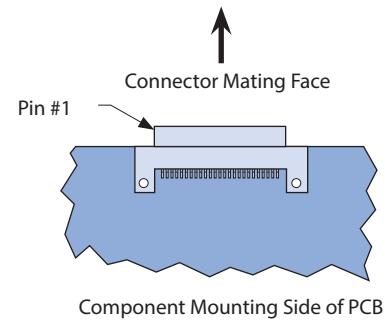

21 Contacts

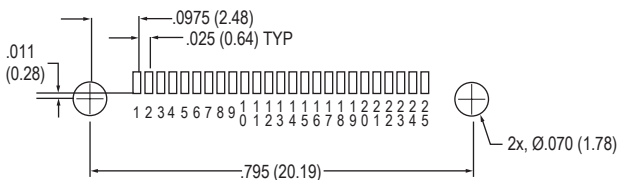

25 Contacts

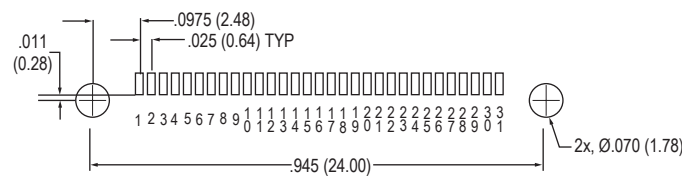
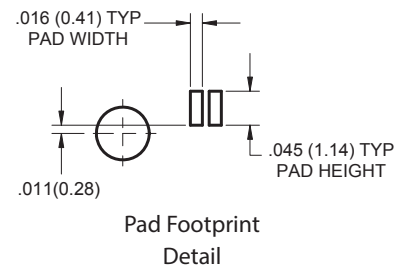

31 Contacts

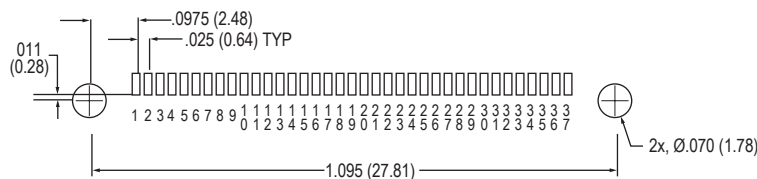

37 Contacts

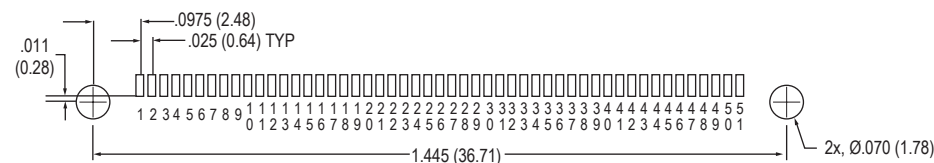

51 Contacts

Layouts shown are for connector mounting side of PC Board.

5 Contacts

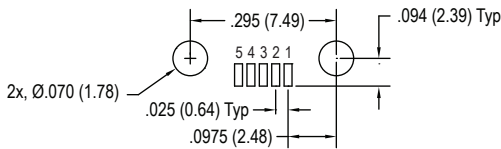

9 Contacts

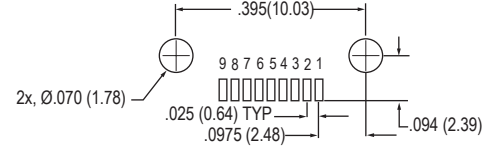

15 Contacts

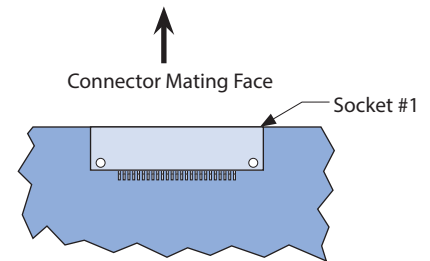
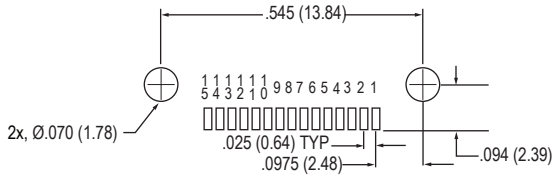

Component Mounting Side of PCB

21 Contacts

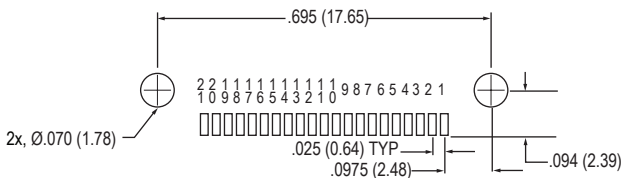

25 Contacts

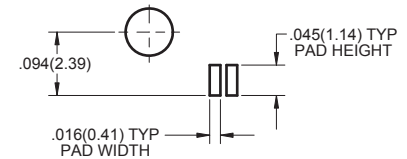
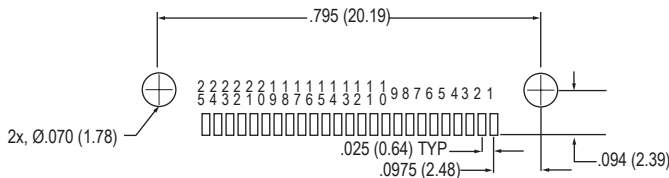

Pad Footprint Detail

31 Contacts

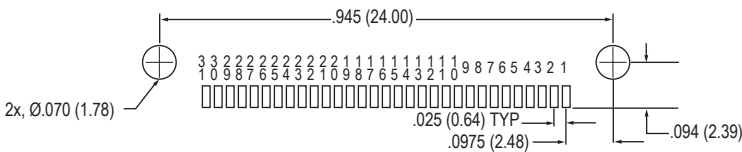

37 Contacts

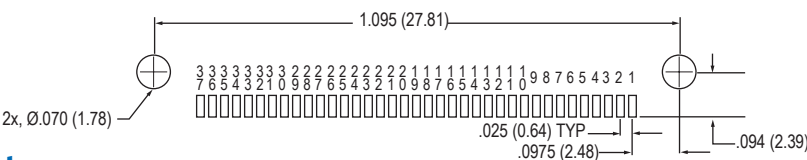

51 Contacts

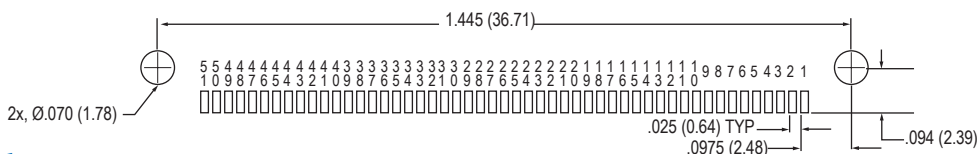

Layouts shown are for connector mounting side of PC Board.

Mouser Electronics

Authorized Distributor

Click to View Pricing, Inventory, Delivery & Lifecycle Information:

[Glenair:](#)

[890-013-51SS-BRST](#) [890-012-51PS-BRST](#) [890-012-31PT-BRST](#)