

SCALA NON IMPEGNATIVA
(DO NOT SCALE)
DIMENSIONI IN mm
(DIMENSIONS IN)

METRIC

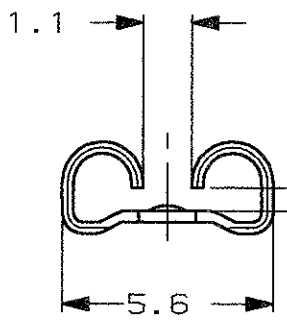

ADATTO PER LINGUETTA DI 0.8 mm
(TO FIT TAB 0.8 mm THK.)

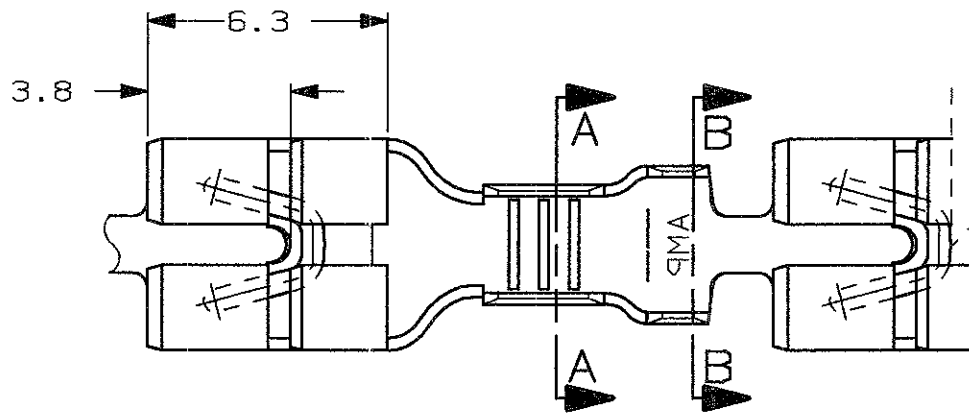
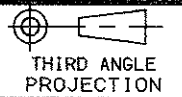
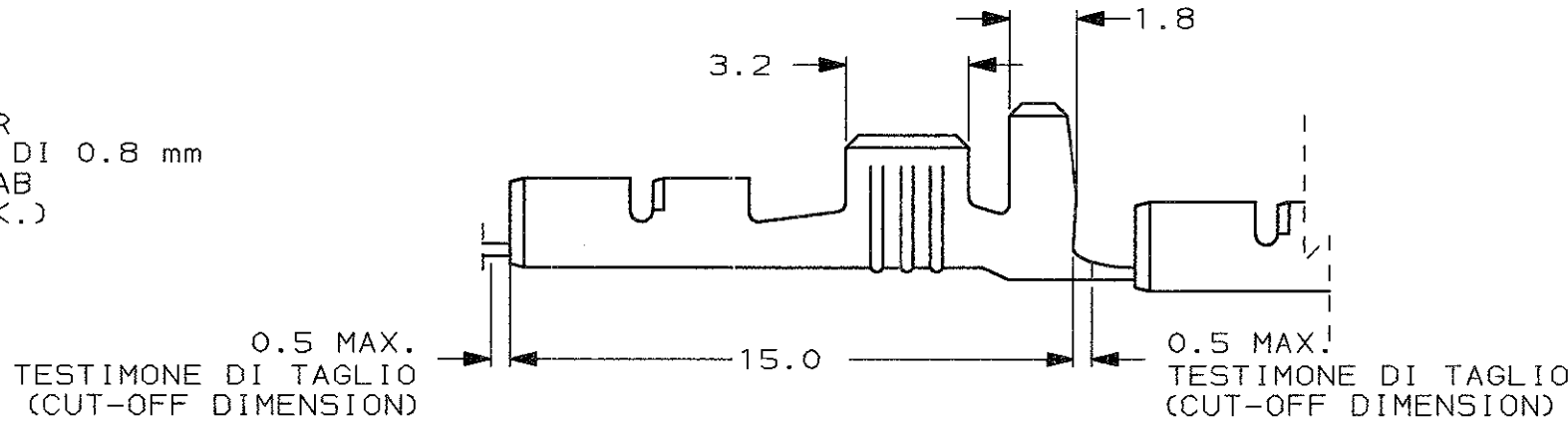

SEZIONE B-B
(SECTION B-B)

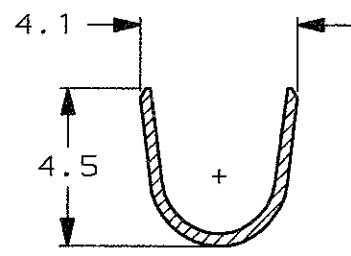

SEZIONE A-A
(SECTION A-A)

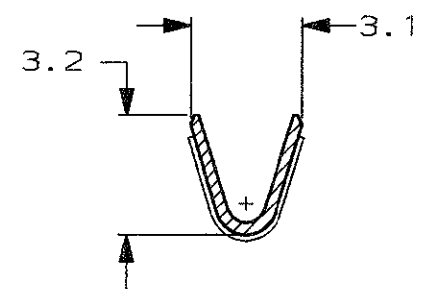

4 OBSOLETE PARTS: OBSOLETE CIS STREAMLINING PER D.RENAUD/D.SINISI

4 OBSOLETE	STAGNATO (TIN PLATED)	BRONZO FOSF. (PHOS. BRONZE)	0-100494-4	E
	STAGNATO (TIN PLATED)	OTTONE (BRASS)	0-100494-2	E
	FINITURA / COLORE (FINISH / COLOUR)	MATERIALE (MATERIAL)	NUMERO (PART NUMBER)	REV

CUSTOMER DWG. FOR REFERENCE ONLY DISEGNO PER CLIENTE SOLO PER RIFERIMENTO

THIS DRAWING IS UNPUBLISHED RELEASE FOR PUBLICATION 19

TOLLERANZE, SE NON DIVERSAMENTE SPECIFICATO (TOLERANCES, UNLESS OTHERWISE SPECIFIED)	DIAM. ISOLANTE (INS. DIA. RANGE) mm	RANGO FILO (WIRE RANGE) mm2	SCALA (SCALE)
± 0.3	2.3-3.3 DIA.	0.5-1.5	5:1

ANGOLI (ANGLES) ± 2°

TE TE Connectivity

DIS. H. YAALI (DR.) 30 MAR 2000 DESCRIZIONE (DESCRIPTION) FASTON® Connector, .187" sr. L.I.F. REC. CONTACT.

CONT. C. TARTARI (CHK) 30 MAR 2000

REV. (REV. LTR.)	REVISIONI (REVISION RECORD)	DIS. (DR)	DATA (DATE)	APP. (APP.)	LOC. (LOC.)	SIZE (SIZE)	NUMERO (DWG NO)	REV.	FOGLIO (SHEET)
E3	REVISED PER ECO-11-005140	RK	31MAR11		I	A3	C-100494	E3	1 OF 1

1) STATO DI FORNITURA SCALA 1:1 (SUPPLY CONDITION SCALE 1:1)

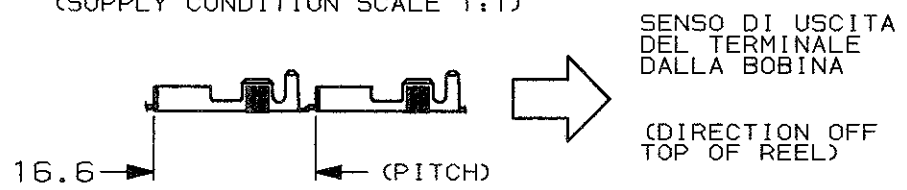

- 2) SPECIFICA DI PRODOTTO 108-19077 (PRODUCT SPEC. 108-19077)
- 3) SPECIFICA DI AGGRAFFATURA 114-20081 (APPLICATION SPEC. 114-20081)

DISTRIBUZIONE (PRINT/DIST.)