

THIS DRAWING IS UNPUBLISHED. RELEASED FOR PUBLICATION

© COPYRIGHT BY TYCO ELECTRONICS CORPORATION. ALL RIGHTS RESERVED.

LOC	DIST	REVISIONS					
G	14	P	LTR	DESCRIPTION	DATE	DWN	APVD
			F1	REV PER ECR 07-015095	25JUN07	JR	TM

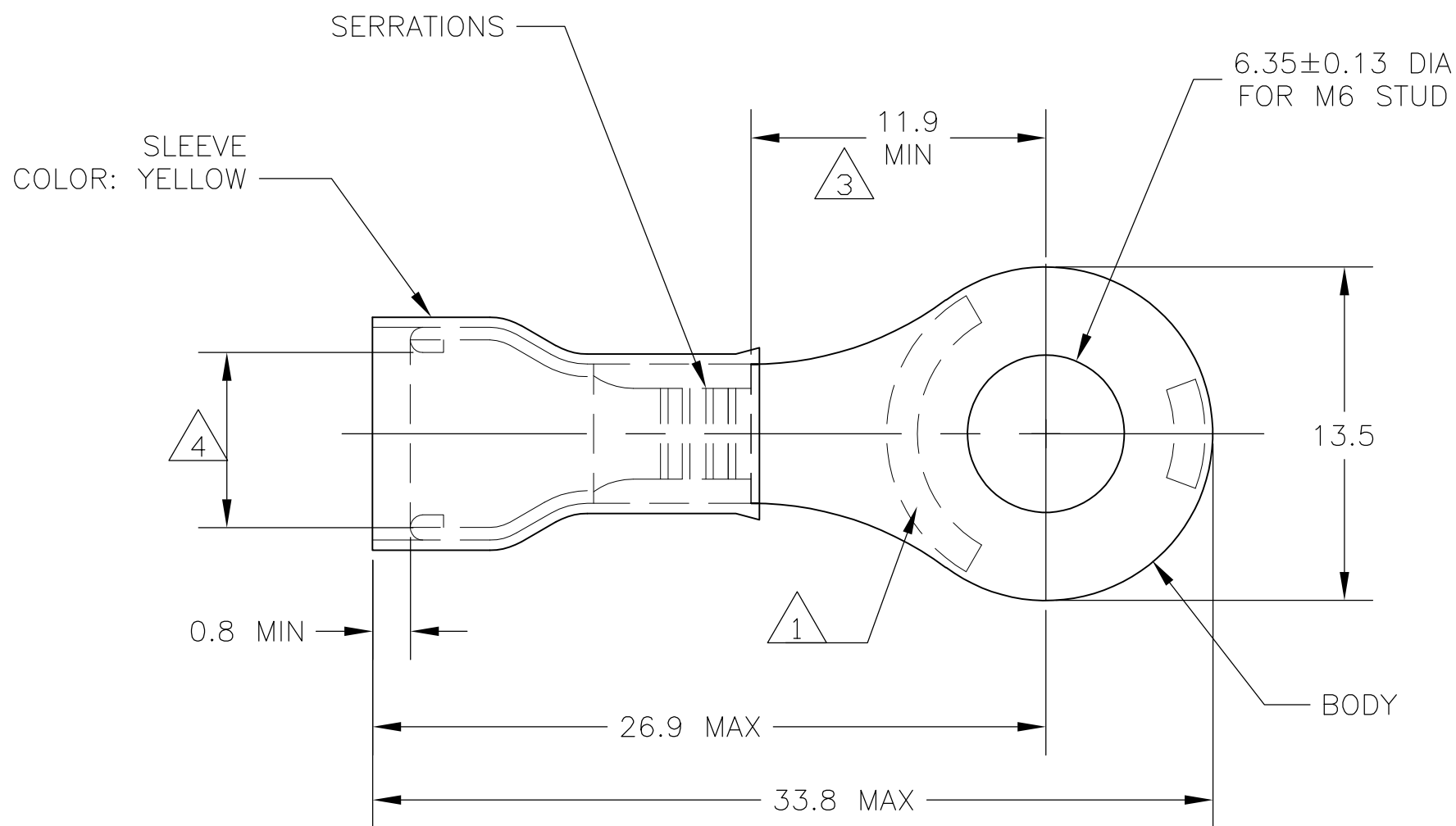

- 1 STAMP "AMP 12-10\*", LOCATION APPROX AS SHOWN.
- 2 TONGUE THICKNESS IS 1.0±0.05
- 3 APPLIES TO EDGE OF METAL WIRE BARREL TO CENTER OF STUD HOLE.
- 4 WIRE INSULATION DIA RANGE 3.8-6.4
- 5 BODY - COPPER PER ASTM B-152 SLEEVE - COPPER PER ASTM B-152 INSULATION - NYLON
- 6 BODY - TIN PL PER ASTM B-545 SLEEVE - TIN PL PER ASTM B-545 INSULATION - COLOR - YELLOW
- 7 105°C MAX OPERATING TEMPERATURE.
- 8 300 VOLT MAX
- 9 2.62-6.64mm<sup>2</sup> [5,180 - 13,100 CMA] SOLID OR STRANDED

500	LOOSE PIECE	130205
QTY	PACKAGE TYPE	PART NO

THIS DRAWING IS A CONTROLLED DOCUMENT.		DWN jr_ruth 10APR07	Tyco Electronics Corporation Harrisburg, PA 17105-3608	
DIMENSIONS: mm INCHES		CHK T MICHIELUTTI 10APR07	NAME TERMINAL RING TONGUE, PIDG, WIRE SIZE 12-10	
TOLERANCES UNLESS OTHERWISE SPECIFIED: 0 PLC ± - 1 PLC ± 0.2 2 PLC ± - 3 PLC ± - 4 PLC ± - ANGLES ± 5°		APVD T MICHIELUTTI 10APR07	PRODUCT SPEC - APPLICATION SPEC -	
MATERIAL	FINISH	WEIGHT	SIZE A3	CAGE CODE 00779
-5	-6	-	DRAWING NO G-130205	RESTRICTED TO -
CUSTOMER DRAWING			SCALE 4:1	SHEET 1 OF 1
			REV F1	