

## N-Channel Enhancement Mode Field Effect Transistor

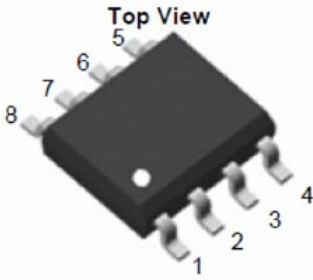

**SOP-8**

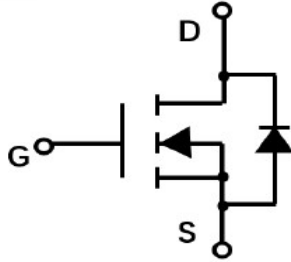
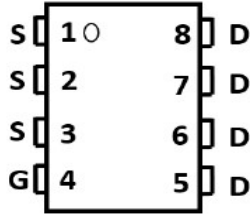

### Product Summary

- $V_{DS}$  30V
- $I_D$  18A
- $R_{DS(ON)}$  (at  $V_{GS}=10V$ ) <7.0mohm
- $R_{DS(ON)}$  (at  $V_{GS}=4.5V$ ) <10.0mohm

### General Description

- Trench Power LV MOSFET technology
- High density cell design for low  $R_{DS(ON)}$
- High Speed switching

### Applications

- Battery protection
- Load switch
- Power management

### ■ Absolute Maximum Ratings ( $T_A=25^\circ\text{C}$ unless otherwise noted)

Parameter	Symbol	Limit	Unit
Drain-source Voltage	$V_{DS}$	30	V
Gate-source Voltage	$V_{GS}$	$\pm 20$	V
Drain Current	$I_D$	$T_A=25^\circ\text{C}$ @ Steady State	18
		$T_A=70^\circ\text{C}$ @ Steady State	14.5
Pulsed Drain Current <sup>A</sup>	$I_{DM}$	65	A
Total Power Dissipation @ $T_A=25^\circ\text{C}$	$P_D$	3.0	W
Thermal Resistance Junction-to-Ambient @ Steady State <sup>B</sup>	$R_{\theta JA}$	42	$^\circ\text{C}/\text{W}$
Junction and Storage Temperature Range	$T_J, T_{STG}$	-55~+150	$^\circ\text{C}$

### ■ Ordering Information (Example)

PREFERRED P/N	PACKING CODE	Marking	MINIMUM PACKAGE(pcs)	INNER BOX QUANTITY(pcs)	OUTER CARTON QUANTITY(pcs)	DELIVERY MODE
YJS18N03A	F2	Q18N03.	4000	8000	64000	13" reel



# YJS18N03A

## ■ Electrical Characteristics (T<sub>J</sub>=25°C unless otherwise noted)

Parameter	Symbol	Conditions	Min	Typ	Max	Units
<b>Static Parameter</b>						
Drain-Source Breakdown Voltage	BV <sub>DSS</sub>	V <sub>GS</sub> = 0V, I <sub>D</sub> =250μA	30			V
Zero Gate Voltage Drain Current	I <sub>DSS</sub>	V <sub>DS</sub> =30V, V <sub>GS</sub> =0V			1	μA
Gate-Body Leakage Current	I <sub>GSS</sub>	V <sub>GS</sub> = ±20V, V <sub>DS</sub> =0V			±100	nA
Gate Threshold Voltage	V <sub>GS(th)</sub>	V <sub>DS</sub> = V <sub>GS</sub> , I <sub>D</sub> =250μA	1	1.5	2.5	V
Static Drain-Source On-Resistance	R <sub>DS(on)</sub>	V <sub>GS</sub> =10V, I <sub>D</sub> =18A		4.5	7.0	mΩ
		V <sub>GS</sub> = 4.5V, I <sub>D</sub> =10A		6.6	10	
Diode Forward Voltage	V <sub>SD</sub>	I <sub>S</sub> =12A, V <sub>GS</sub> =0V		0.85	1.2	V
Maximum Body-Diode Continuous Current	I <sub>S</sub>				18	A
<b>Dynamic Parameters</b>						
Input Capacitance	C <sub>iss</sub>	V <sub>DS</sub> =15V, V <sub>GS</sub> =0V, f=1MHZ		2191		pF
Output Capacitance	C <sub>oss</sub>			300		
Reverse Transfer Capacitance	C <sub>rss</sub>			247		
<b>Switching Parameters</b>						
Total Gate Charge	Q <sub>g</sub>	V <sub>GS</sub> =10V, V <sub>DS</sub> =15V, I <sub>D</sub> =20A		46.3		nC
Gate-Source Charge	Q <sub>gs</sub>			8.8		
Gate-Drain Charge	Q <sub>gd</sub>			9.2		
Reverse Recovery Charge	Q <sub>rr</sub>	I <sub>F</sub> =20A, di/dt=100A/us		1.6		
Reverse Recovery Time	t <sub>rr</sub>			11		
Turn-on Delay Time	t <sub>D(on)</sub>	V <sub>GS</sub> =10V, V <sub>DD</sub> =15V, R <sub>L</sub> =0.75Ω R <sub>GEN</sub> =3Ω		11		ns
Turn-on Rise Time	t <sub>r</sub>			80		
Turn-off Delay Time	t <sub>D(off)</sub>			39		
Turn-off fall Time	t <sub>f</sub>			92		

A. Pulse Test: Pulse Width ≤ 300us, Duty cycle ≤ 2%.

B. R<sub>θJA</sub> is the sum of the junction-to-lead and lead-to-ambient thermal resistance, where the lead thermal reference is defined as the solder mounting surface of the drain pins. R<sub>θJL</sub> is guaranteed by design, while R<sub>θJA</sub> is determined by the board design. The maximum rating presented here is based on mounting on a 1 in 2 pad of 2oz copper.



■ Typical Performance Characteristics

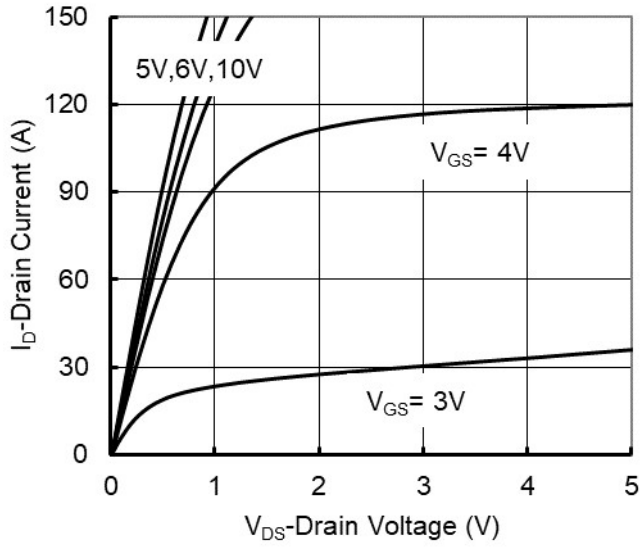

Figure 1. Output Characteristics

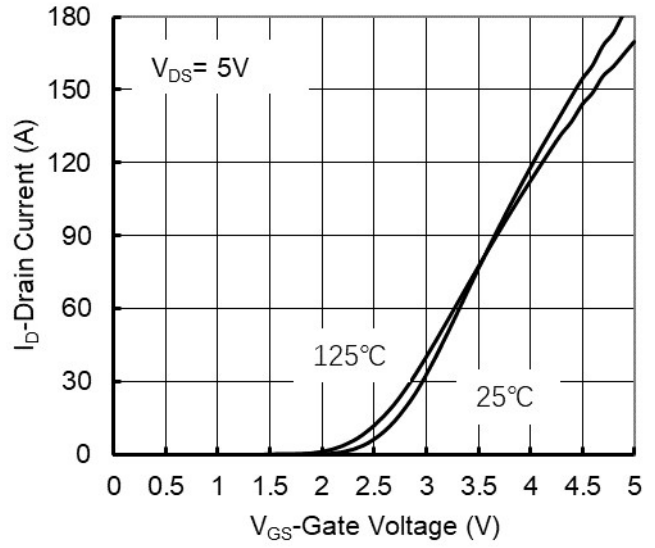

Figure 2. Transfer Characteristics

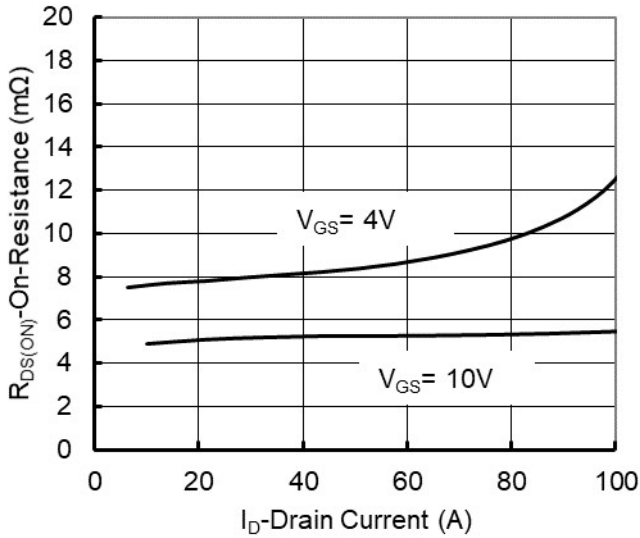

Figure 3. On-Resistance vs. Drain Current and Gate Voltage

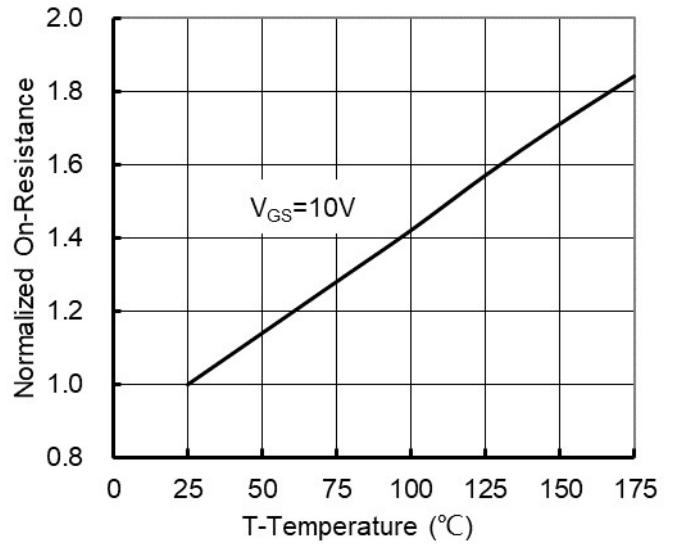

Figure 4. On-Resistance vs. Junction Temperature

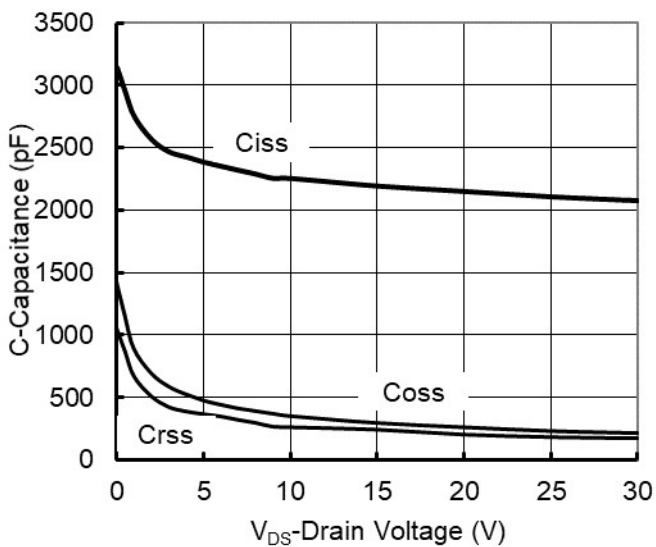

Figure 5. Capacitance Characteristics

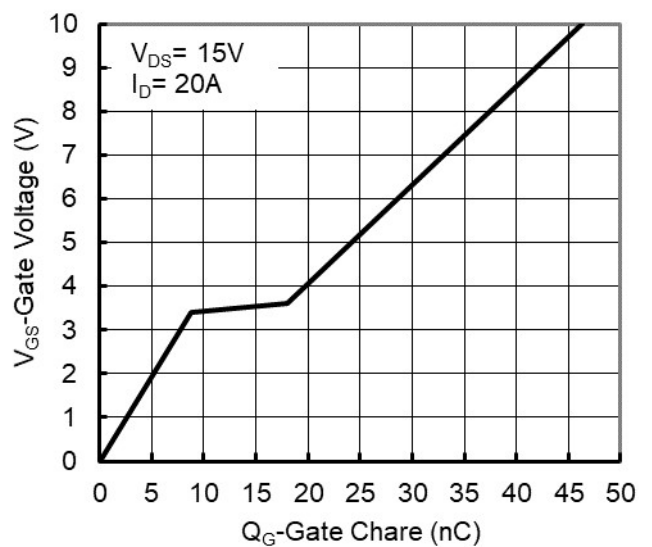

Figure 6. Gate Charge



# YJS18N03A

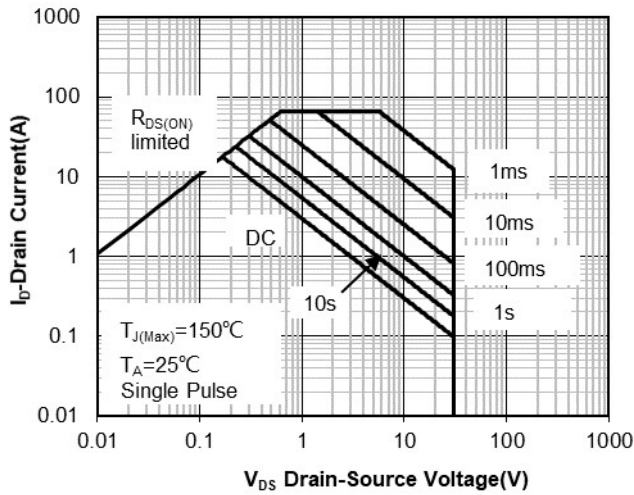

Figure 7. Safe Operation Area

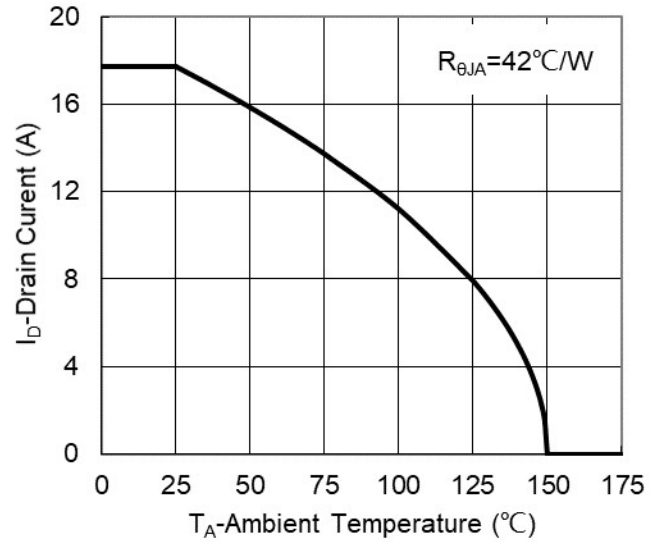

Figure 8. Maximum Continuous Drain Current vs Ambient Temperature

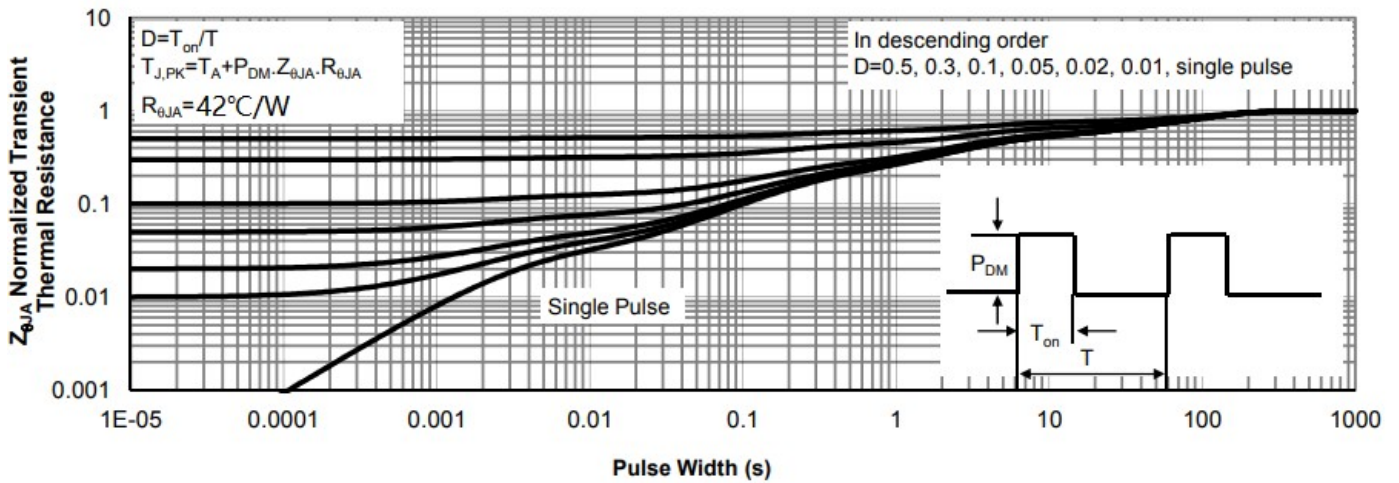
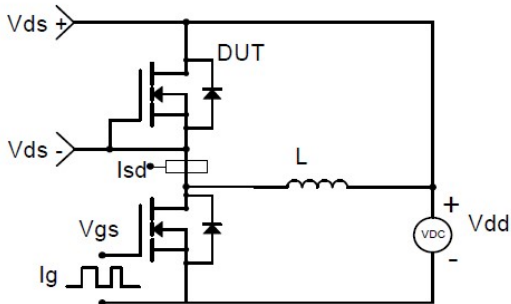

Figure 9. Normalized Maximum Transient Thermal Impedance



**Resistive Switching Test Circuit & Waveforms**



**Diode Recovery Test Circuit & Waveforms**



**Gate Charge Test Circuit & Waveform**



**Unclamped Inductive Switching (UIS) Test Circuit & Waveforms**



# YJS18N03A

## ■ SOP-8 Package information

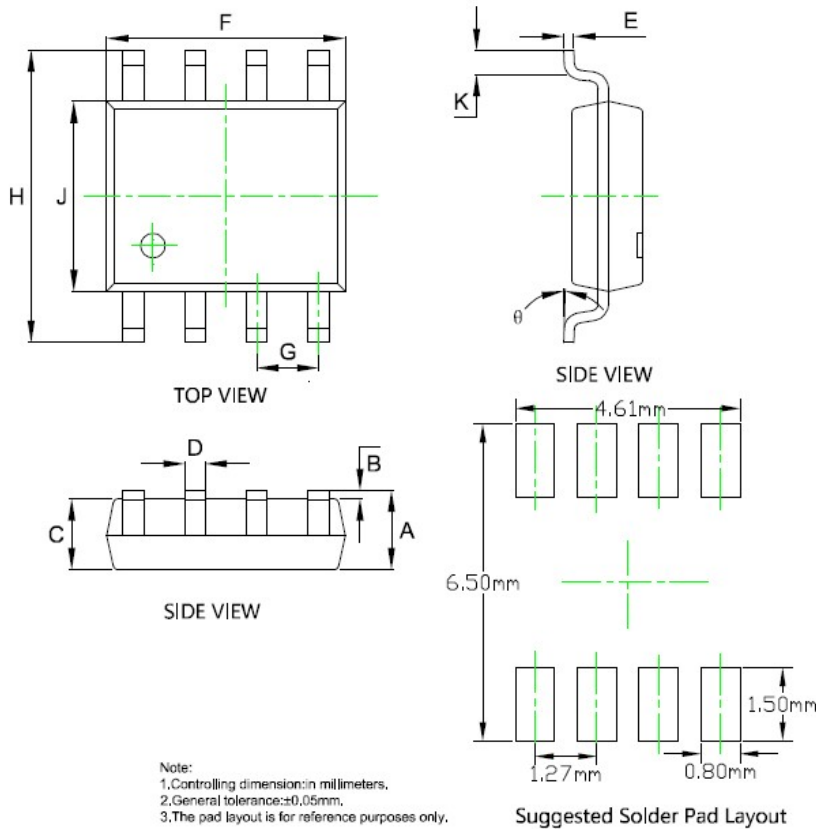

SYMBOL	DIMENSIONS			
	INCHES		Millimeter	
	MIN.	MAX.	MIN.	MAX.
A	0.053	0.069	1.350	1.750
B	0.004	0.010	0.100	0.250
C	0.053	0.061	1.350	1.550
D	0.013	0.020	0.330	0.510
E	0.007	0.010	0.170	0.250
F	0.189	0.197	4.800	5.000
G	0.050BSC		1.270BSC	
H	0.228	0.244	5.800	6.200
J	0.150	0.157	3.800	4.000
K	0.016	0.050	0.400	1.270
θ	0°	8°	0°	8°



## Disclaimer

The information presented in this document is for reference only. Yangzhou Yangjie Electronic Technology Co., Ltd. reserves the right to make changes without notice for the specification of the products displayed herein to improve reliability, function or design or otherwise.

The product listed herein is designed to be used with ordinary electronic equipment or devices, and not designed to be used with equipment or devices which require high level of reliability and the malfunction of which would directly endanger human life (such as medical instruments, transportation equipment, aerospace machinery, nuclear-reactor controllers, fuel controllers and other safety devices), Yangjie or anyone on its behalf, assumes no responsibility or liability for any damages resulting from such improper use of sale.

This publication supersedes & replaces all information previously supplied. For additional information, please visit our website [http:// www.21yangjie.com](http://www.21yangjie.com) , or consult your nearest Yangjie's sales office for further assistance.