

PCB Connector Series

KLS1-4.20 Pitch=4.20mm TYPE

Electrical Specification:

Rated Voltage: 300V AC/DC
 Rated Current: 9A
 Contact Resistance: 0.015Ω max
 Insulation Resistance: 1000MΩ min
 Withstand voltage: 1500V AC/MIN
 Temperature range for usage : -40°C~+105°C

Material:

Housing: PA66 (PA66) UL94V-2
 Contacts: Phosphor Bronze
 Plating: Tin 50u" over 100u" nickel
 Wire range : AWG#30~#22

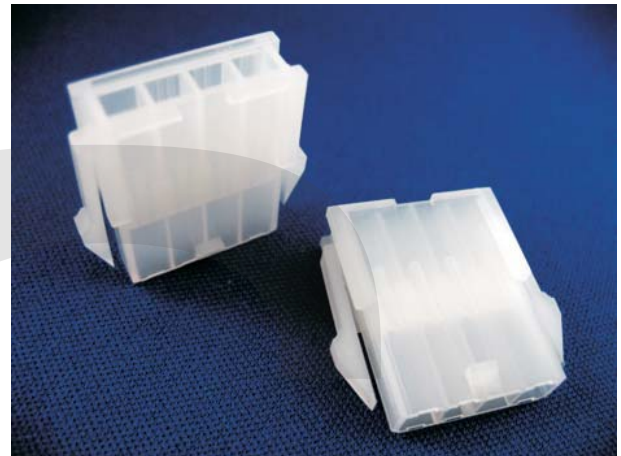

Single layer Female Housing

PART NO.	Dimensions	
	A	B
02	4.20	9.60
03	8.40	13.80
04	12.60	18.00
05	16.80	22.20

mate with terminl p/n: KLS1-4.20-MT

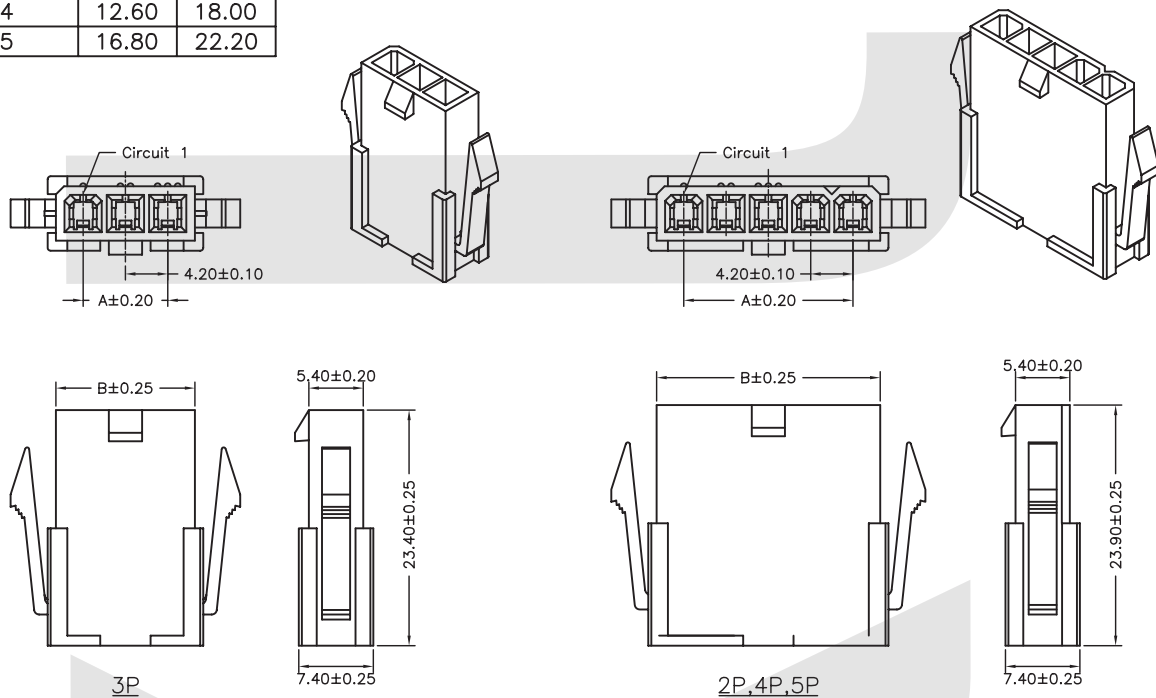

ORDER INFORMATION

Product NO.: KLS1-4.20 -1X05-FH

Pitch: 4.20=4.20mm
 Pins: 1-Single layer
 Pin Number: 2~12Pin

2-Double layer

Type: MH=Male Housing FT=Female Terminal
 FH=Female Housing MT=Male Terminal
 S=Straight pin R=Right pin
 SW=Straight pin with Peg RW=Right pin with Peg
 SB=Straight pin Special Type RB=Right pin with Ears

PCB Connector Series

KLS1-4.20 Pitch=4.20mm TYPE

Electrical Specification:

Rated Voltage: 300V AC/DC
 Rated Current: 9A
 Contact Resistance: 0.015Ω max
 Insulation Resistance: 1000MΩ min
 Withstand voltage: 1500V AC/MIN
 Temperature range for usage : -40°C~+105°C

Material:

Housing: PA66 (PA66) UL94V-2
 Contacts: Phosphor Bronze
 Plating: Tin 50u" over 100u" nickel
 Wire range : AWG#30~#22

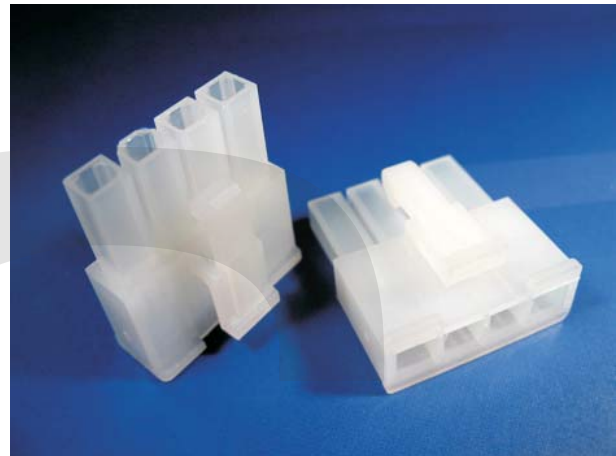

Single layer Male Housing

PART NO.	Dimensions	
	A	B
02	4.20	9.60
03	8.40	13.80
04	12.60	18.00
05	16.80	22.20



mate with terminl p/n: KLS1-4.20-FT

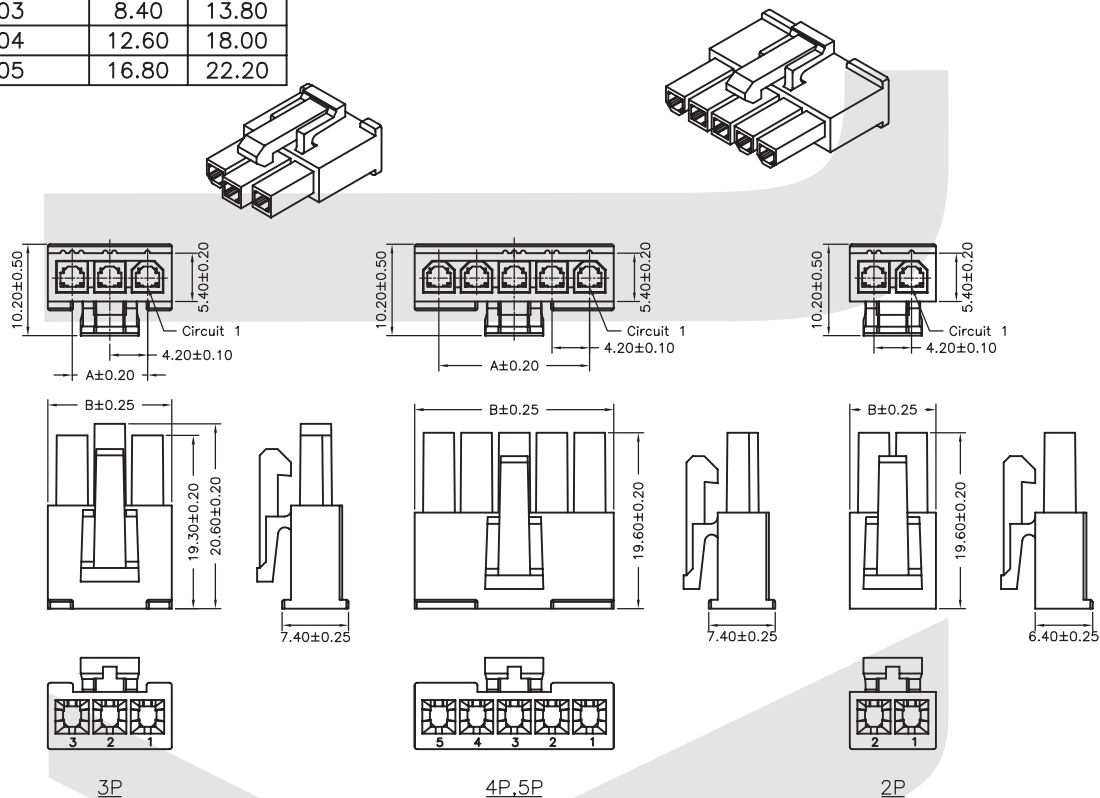

ORDER INFORMATION

Product NO.: KLS1-4.20 -1X05- MH

Pitch: 4.20=4.20mm
 Pins: 1-Single layer
 Pin Number: 2~12Pin

2-Double layer

Type: MH=Male Housing FT=Female Terminal
 FH=Female Housing MT=Male Terminal
 S=Straight pin R=Right pin
 SW=Straight pin with Peg RW=Right pin with Peg
 SB=Straight pin Special Type RB=Right pin with Ears

PCB Connector Series

KLS1-4.20 Pitch=4.20mm TYPE

Electrical Specification:

Rated Voltage: 300V AC/DC
 Rated Current: 9A
 Contact Resistance: 0.015Ω max
 Insulation Resistance: 1000MΩ min
 Withstand voltage: 1500V AC/MIN
 Temperature range for usage : -40°C~+105°C

Material:

Housing: PA66 (PA66) UL94V-2
 Contacts: Phosphor Bronze
 Plating: Tin 50u" over 100u" nickel
 Wire range : AWG#30~#22

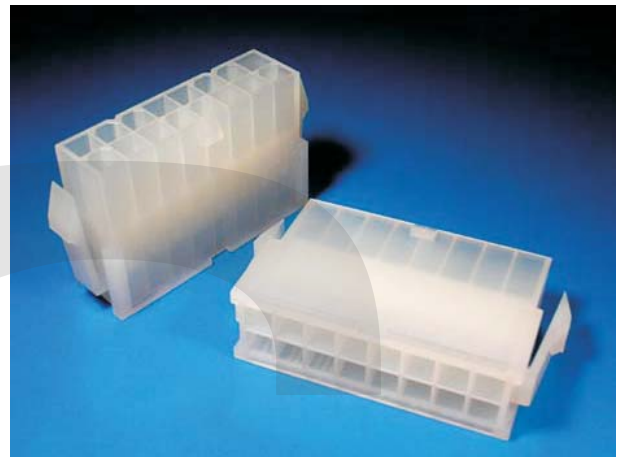

Double layer Female Housing

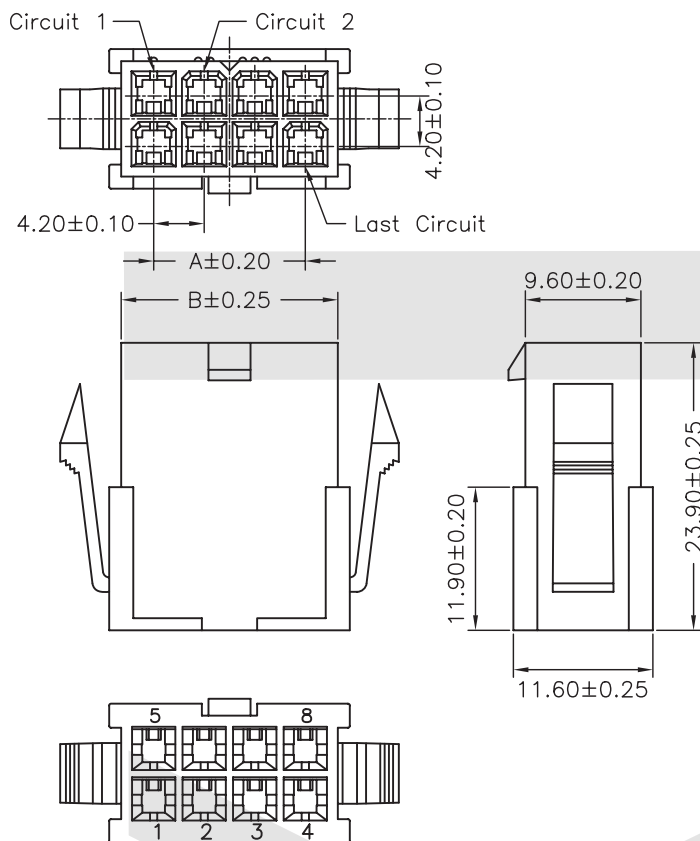

mate with terminl p/n: KLS1-4.20-MT

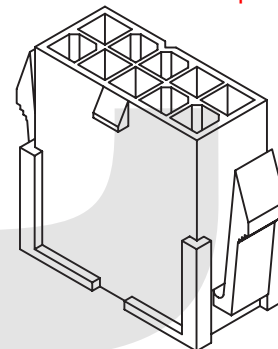

PART NO.	Dimensions	
	A	B
2X01	---	5.40
2X02	4.20	9.60
2X03	8.40	13.80
2X04	12.60	18.00
2X05	16.80	22.20
2X06	21.00	26.40
2X07	25.20	30.60
2X08	29.40	34.80
2X09	33.60	39.00
2X10	37.80	43.20
2X11	42.00	47.40
2X12	46.20	51.60

ORDER INFORMATION

Product NO.: KLS1-4.20 -2X05-FH

Pitch: 4.20=4.20mm
 Pins: 1-Single layer
 Pin Number: 2~12Pin

2-Double layer

Type: MH=Male Housing FT=Female Terminal
 FH=Female Housing MT=Male Terminal
 S=Straight pin R=Right pin
 SW=Straight pin with Peg RW=Right pin with Peg
 SB=Straight pin Special Type RB=Right pin with Ears

PCB Connector Series

KLS1-4.20 Pitch=4.20mm TYPE

Electrical Specification:

- Rated Voltage: 300V AC/DC
- Rated Current: 9A
- Contact Resistance: 0.015Ω max
- Insulation Resistance: 1000MΩ min
- Withstand voltage: 1500V AC/MIN
- Temperature range for usage : -40°C~+105°C

Material:

- Housing: PA66 (PA66) UL94V-2
- Contacts: Phosphor Bronze
- Plating: Tin 50u" over 100u" nickel
- Wire range : AWG#30~#22

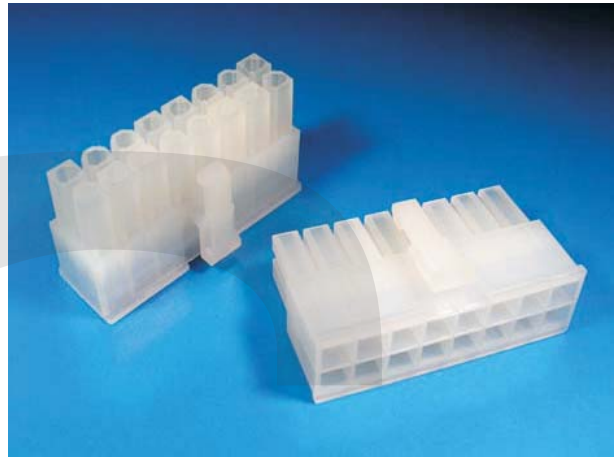

Double layer Male Housing

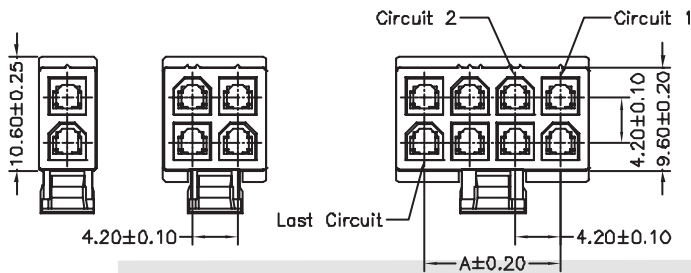

mate with terminl p/n: KLS1-4.20-FT

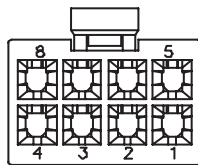
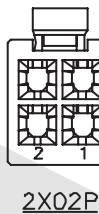
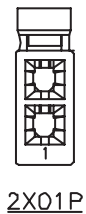
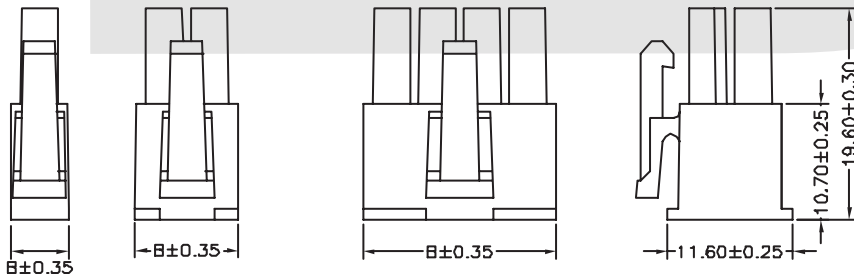
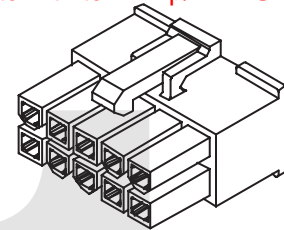

PART NO.	Dimensions	
	A	B
2X01	---	5.70
2X02	4.20	9.60
2X03	8.40	13.80
2X04	12.60	18.00
2X05	16.80	22.20
2X06	21.00	26.40
2X07	25.20	30.60
2X08	29.40	34.80
2X09	33.60	39.00
2X10	37.80	43.20
2X11	42.00	47.40
2X12	46.20	51.60

ORDER INFORMATION

Product NO.: KLS1-4.20 -2X05- MH

- Pitch: 4.20=4.20mm
- Pins: 1-Single layer 2-Double layer
- Pin Number: 2~12Pin
- Type: MH=Male Housing FT=Female Terminal
- FH=Female Housing MT=Male Terminal
- S=Straight pin R=Right pin
- SW=Straight pin with Peg RW=Right pin with Peg
- SB=Straight pin Special Type RB=Right pin with Ears

PCB Connector Series

KLS1-4.20 Pitch=4.20mm TYPE

Electrical Specification:

Rated Voltage: 300V AC/DC
 Rated Current: 9A
 Contact Resistance: 0.015Ω max
 Insulation Resistance: 1000MΩ min
 Withstand voltage: 1500V AC/MIN
 Temperature range for usage : -40°C~+105°C

Material:

Housing: PA66 (PA66) UL94V-2
 Contacts: Brass
 Plating: Tin 50u" over 100u" nickel
 Wire range : AWG#30~#22

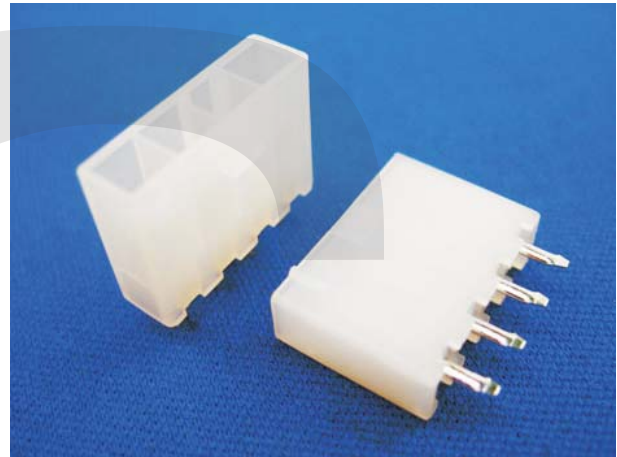

Single layer Straight pin

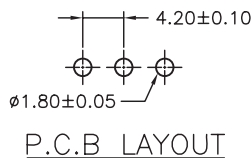
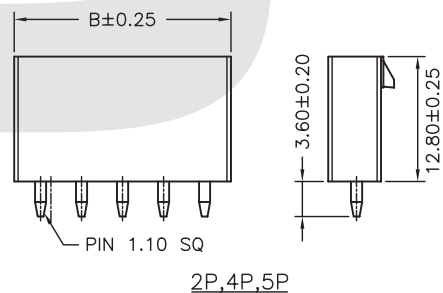
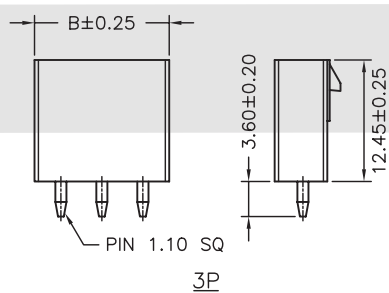
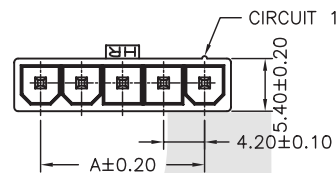
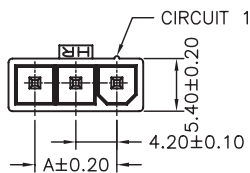

PART NO.	Dimensions	
	A	B
02	4.20	9.60
03	8.40	13.80
04	12.60	18.00
05	16.80	22.20

ORDER INFORMATION

Product NO.: KLS1-4.20 -1X05- S

Pitch: 4.20=4.20mm
 Pins: 1-Single layer
 Pin Number: 2~12Pin

2-Double layer

Type: MH=Male Housing FT=Female Terminal
 FH=Female Housing MT=Male Terminal
 S=Straight pin R=Right pin
 SW=Straight pin with Peg RW=Right pin with Peg
 SB=Straight pin Special Type RB=Right pin with Ears

PCB Connector Series

KLS1-4.20 Pitch=4.20mm TYPE

Electrical Specification:

Rated Voltage: 300V AC/DC
 Rated Current: 9A
 Contact Resistance: 0.015Ω max
 Insulation Resistance: 1000MΩ min
 Withstand voltage: 1500V AC/MIN
 Temperature range for usage : -40°C~+105°C

Material:

Housing: PA66 (PA66) UL94V-2
 Contacts: Brass
 Plating: Tin 50u" over 100u" nickel
 Wire range : AWG#30~#22

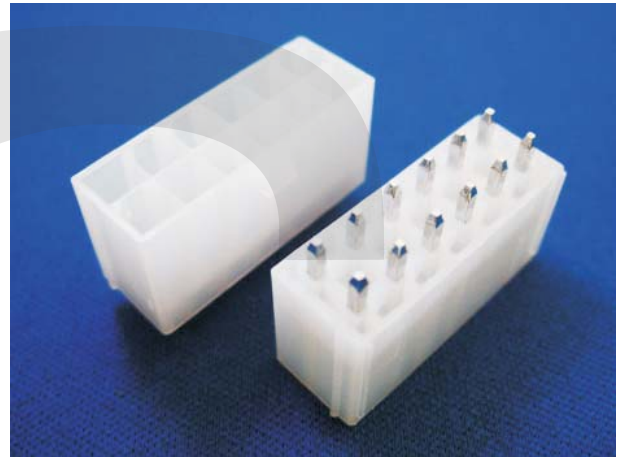

Double layer Straight pin

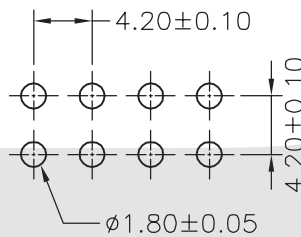
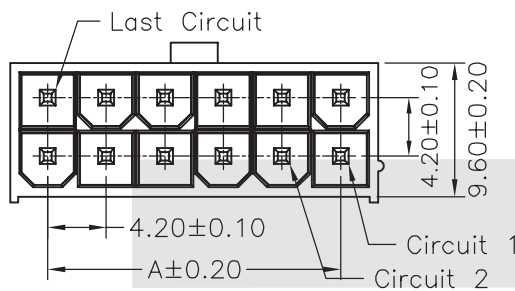

P.C.B LAYOUT

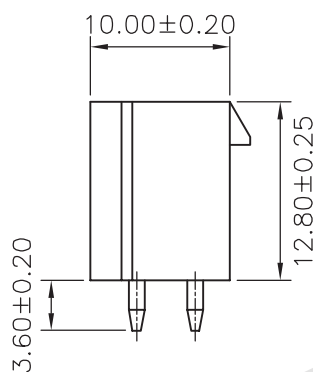
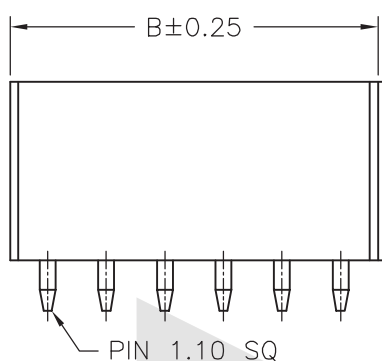
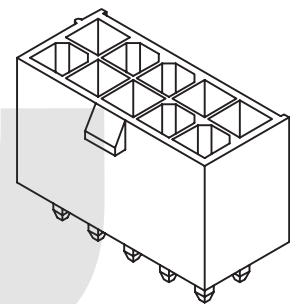

PART NO.	Dimensions	
	A	B
2X01	---	5.40
2X02	4.20	9.60
2X03	8.40	13.80
2X04	12.60	18.00
2X05	16.80	22.20
2X06	21.00	26.40
2X07	25.20	30.60
2X08	29.40	34.80
2X09	33.60	39.00
2X10	37.80	43.20
2X11	42.00	47.40
2X12	46.20	51.60

ORDER INFORMATION

Product NO.: KLS1-4.20 -2X05- S

Pitch: 4.20=4.20mm
 Pins: 1-Single layer
 Pin Number: 2~12Pin

2-Double layer

Type: MH=Male Housing FT=Female Terminal
 FH=Female Housing MT=Male Terminal
 S=Straight pin R=Right pin
 SW=Straight pin with Peg RW=Right pin with Peg
 SB=Straight pin Special Type RB=Right pin with Ears

PCB Connector Series

KLS1-4.20 Pitch=4.20mm TYPE

Electrical Specification:

Rated Voltage: 300V AC.DC
 Rated Current: 9A
 Contact Resistance: 0.015Ω max
 Insulation Resistance: 1000MΩ min
 Withstand voltage: 1500V AC/MIN
 Temperature range for usage : -40°C~+105°C

Material:

Housing: PA66 (PA66) UL94V-2
 Contacts: Brass
 Plating: Tin 50u" over 100u" nickel
 Wire range : AWG#30~#22

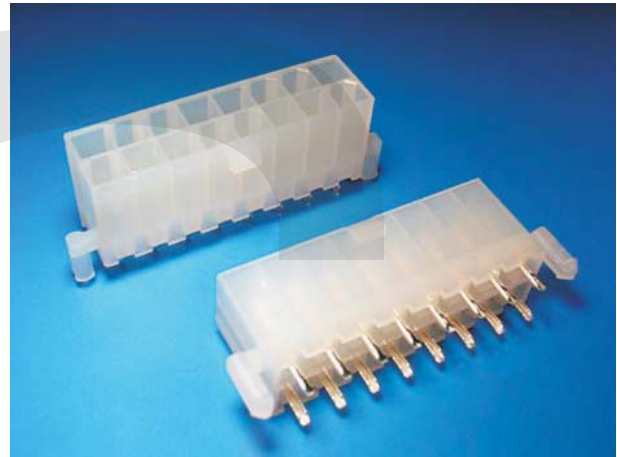

Double layer Straight pin With Peg

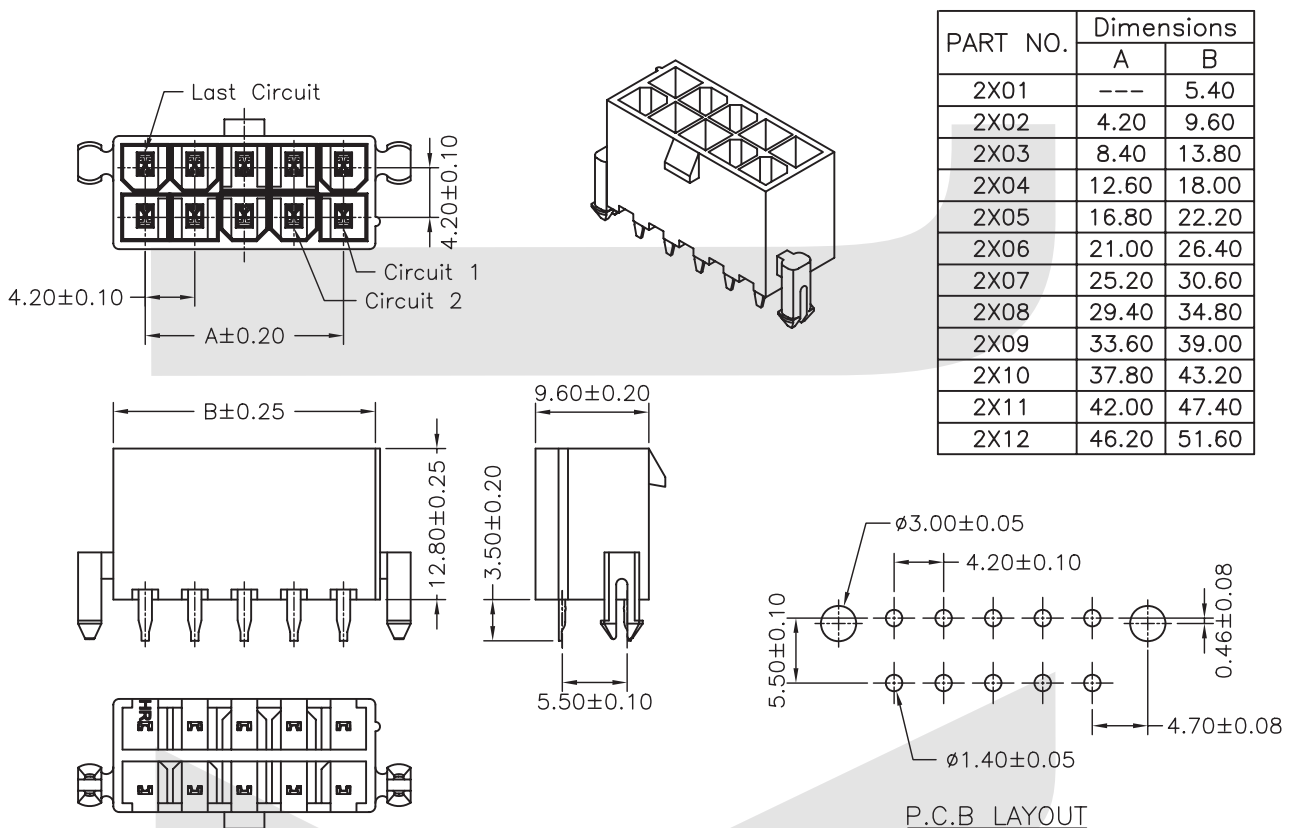

ORDER INFORMATION

Product NO.: KLS1-4.20 -2X05-SW

Pitch: 4.20=4.20mm
 Pins: 1-Single layer
 Pin Number: 2~12Pin

2-Double layer

Type: MH=Male Housing FT=Female Terminal
 FH=Female Housing MT=Male Terminal
 S=Straight pin R=Right pin
 SW=Straight pin with Peg RW=Right pin with Peg
 SB=Straight pin Special Type RB=Right pin with Ears

PCB Connector Series

KLS1-4.20 Pitch=4.20mm TYPE

Electrical Specification:

Rated Voltage: 300V AC/DC
 Rated Current: 9A
 Contact Resistance: 0.015Ω max
 Insulation Resistance: 1000MΩ min
 Withstand voltage: 1500V AC/MIN
 Temperature range for usage : -40°C~+105°C

Material:

Housing: PA66 (PA66) UL94V-2
 Contacts: Brass
 Plating: Tin 50u" over 100u" nickel
 Wire range : AWG#30~#22

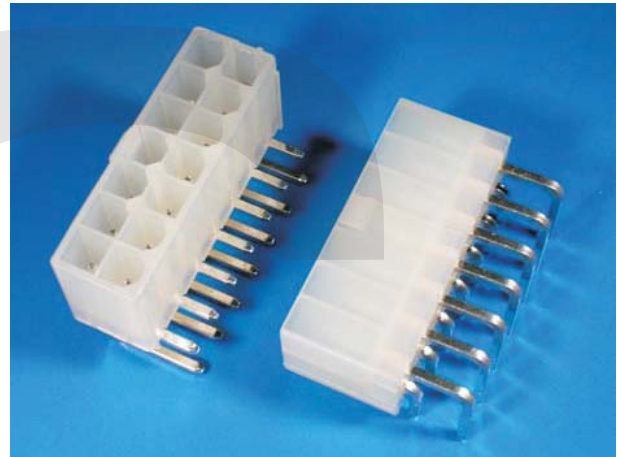

Double layer Right pin

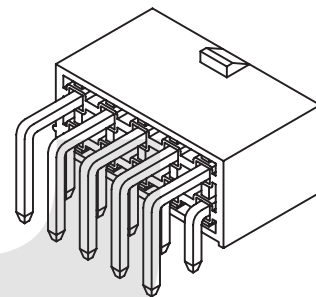
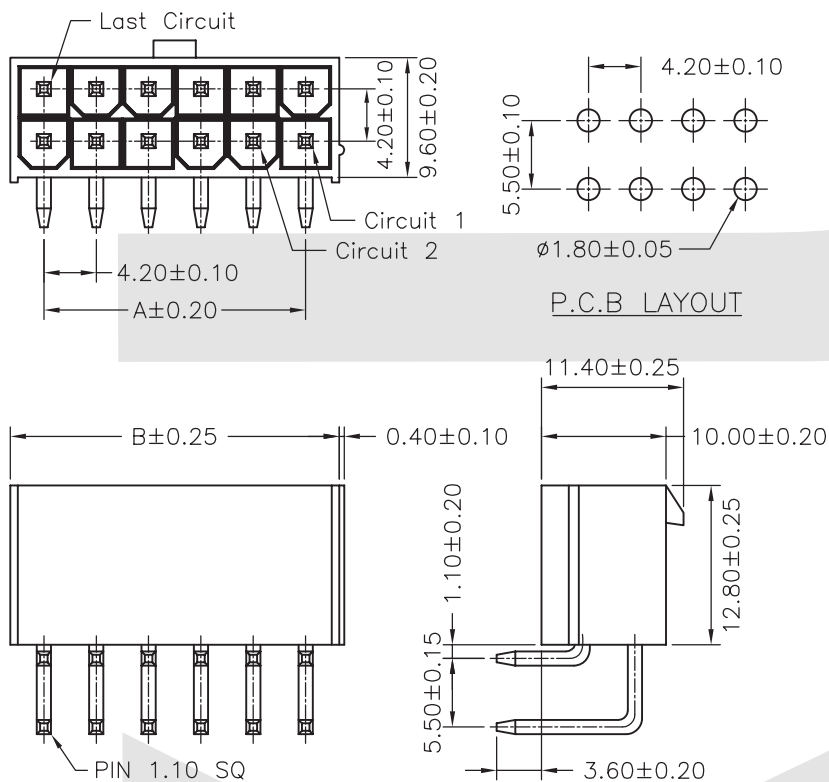

PART NO.	Dimensions	
	A	B
2X01	---	5.40
2X02	4.20	9.60
2X03	8.40	13.80
2X04	12.60	18.00
2X05	16.80	22.20
2X06	21.00	26.40
2X07	25.20	30.60
2X08	29.40	34.80
2X09	33.60	39.00
2X10	37.80	43.20
2X11	42.00	47.40
2X12	46.20	51.60

ORDER INFORMATION

Product NO.: KLS1-4.20 -2X05- R

Pitch: 4.20=4.20mm
 Pins: 1-Single layer
 Pin Number: 2~12Pin

2-Double layer

Type: MH=Male Housing FT=Female Terminal
 FH=Female Housing MT=Male Terminal
 S=Straight pin R=Right pin
 SW=Straight pin with Peg RW=Right pin with Peg
 SB=Straight pin Special Type RB=Right pin with Ears

PCB Connector Series

KLS1-4.20 Pitch=4.20mm TYPE

Electrical Specification:

Rated Voltage: 300V AC.DC
 Rated Current: 9A
 Contact Resistance: 0.015Ω max
 Insulation Resistance: 1000MΩ min
 Withstand voltage: 1500V AC/MIN
 Temperature range for usage : -40°C~+105°C

Material:

Housing: PA66 (PA66) UL94V-2
 Contacts: Brass
 Plating: Tin 50u" over 100u" nickel
 Wire range : AWG#30~#22

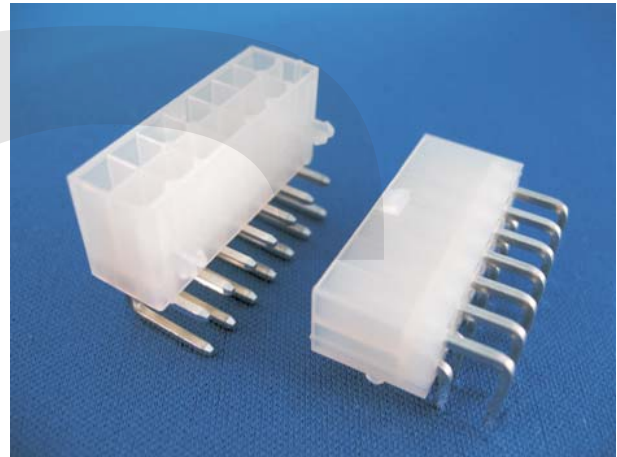

Double layer Right pin With Peg

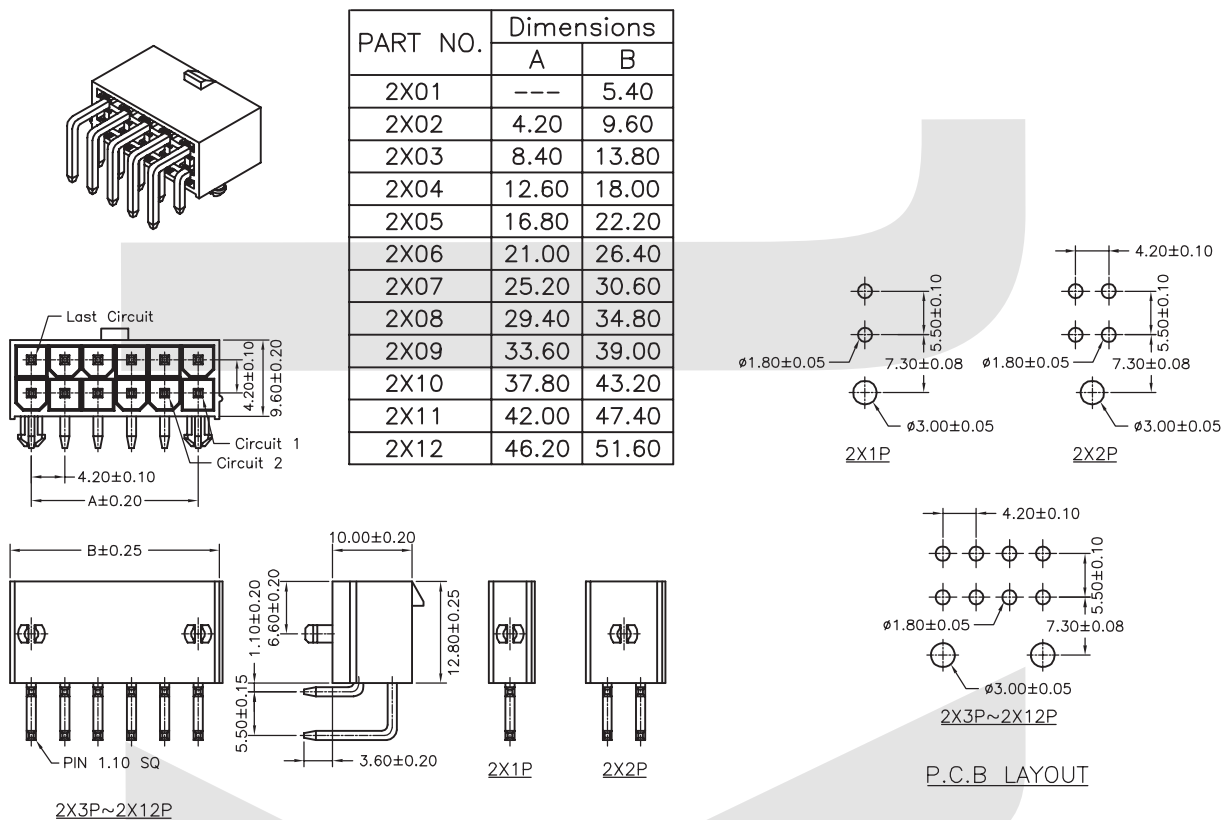

ORDER INFORMATION

Product NO.: KLS1-4.20 -2X05-RW

Pitch: 4.20=4.20mm
 Pins: 1-Single layer 2-Double layer
 Pin Number: 2~12Pin

Type: MH=Male Housing FH=Female Housing S=Straight pin SW=Straight pin with Peg SB=Straight pin Special Type
 FT=Female Terminal MT=Male Terminal R=Right pin RW=Right pin with Peg RB=Right pin with Ears

PCB Connector Series

KLS1-4.20 Pitch=4.20mm TYPE

Electrical Specification:

- Rated Voltage: 300V AC/DC
- Rated Current: 9A
- Contact Resistance: 0.015Ω max
- Insulation Resistance: 1000MΩ min
- Withstand voltage: 1500V AC/MIN
- Temperature range for usage : -40°C~+105°C

Material:

- Housing: PA66 (PA66) UL94V-2
- Contacts: Brass
- Plating: Tin 50u" over 100u" nickel
- Wire range : AWG#30~#22

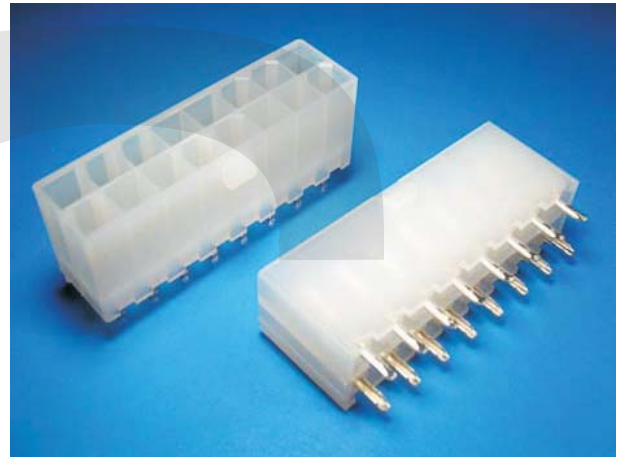

Double layer Straight pin

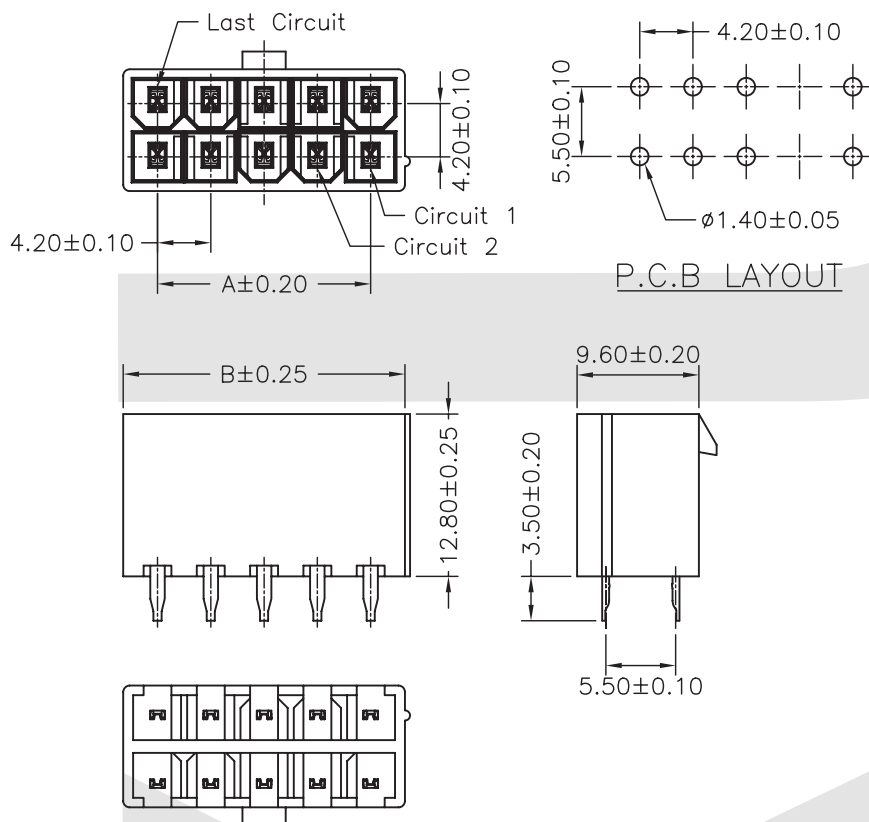

PART NO.	Dimensions	
	A	B
2X01	---	5.40
2X02	4.20	9.60
2X03	8.40	13.80
2X04	12.60	18.00
2X05	16.80	22.20
2X06	21.00	26.40
2X07	25.20	30.60
2X08	29.40	34.80
2X09	33.60	39.00
2X10	37.80	43.20
2X11	42.00	47.40
2X12	46.20	51.60

ORDER INFORMATION

Product NO.: KLS1-4.20 -2X05-SB

Pitch: 4.20=4.20mm
Pins: 1-Single layer
Pin Number: 2~12Pin

2-Double layer

Type: MH=Male Housing FT=Female Terminal
 FH=Female Housing MT=Male Terminal
 S=Straight pin R=Right pin
 SW=Straight pin with Peg RW=Right pin with Peg
 SB=Straight pin Special Type RB=Right pin with Ears

PCB Connector Series

KLS1-4.20 Pitch=4.20mm TYPE

Electrical Specification:

Rated Voltage: 300V AC/DC
 Rated Current: 9A
 Contact Resistance: 0.015 max
 Insulation Resistance: 1000M min
 Withstand voltage: 1500V AC/MIN
 Temperature range for usage : -40°C~+105°C

Material:

Housing: PA66 (PA66) UL94V-2
 Contacts: Brass
 Plating: Tin 50u" over 100u" nickel
 Wire range : AWG#30~#22

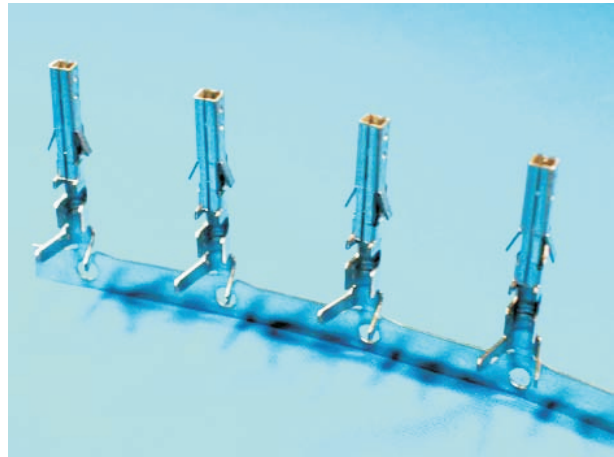

Fem ale Terminal

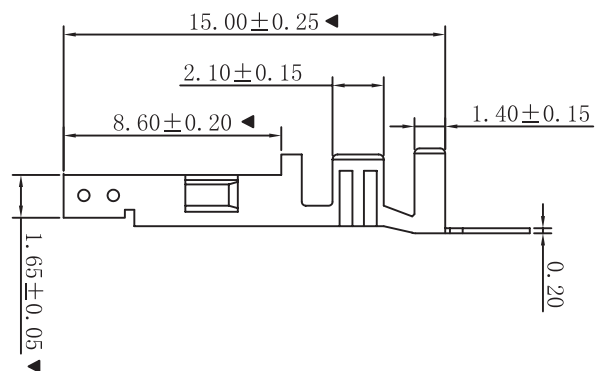
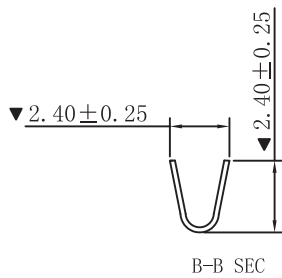
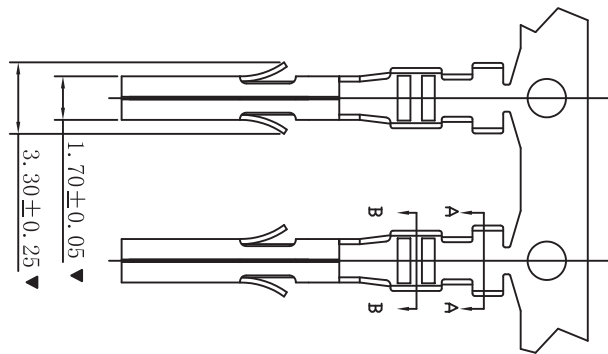
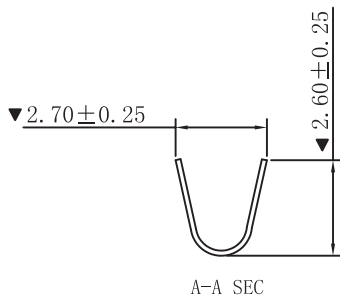

ORDER INFORMATION

Product NO.: KLS1-4.20 -FT

Pitch: 4.20=4.20mm

- Type: MH=Male Housing FT=Female Terminal
- FH=Female Housing MT=Male Terminal
- S=Straight pin R=Right pin
- SW=Straight pin with Peg RW=Right pin with Peg
- SB=Straight pin Special Type RB=Right pin with Ears

PCB Connector Series

KLS1-4.20 Pitch=4.20mm TYPE

Electrical Specification:

Rated Voltage: 300V AC.DC
 Rated Current: 9A
 Contact Resistance: 0.015Ω max
 Insulation Resistance: 1000MΩ min
 Withstand voltage: 1500V AC/MIN
 Temperature range for usage : -40°C~+105°C

Material:

Housing: PA66 (PA66) UL94V-2
 Contacts: Brass
 Plating: Tin 50u" over 100u" nickel
 Wire range : AWG#30~#22



Male Terminal

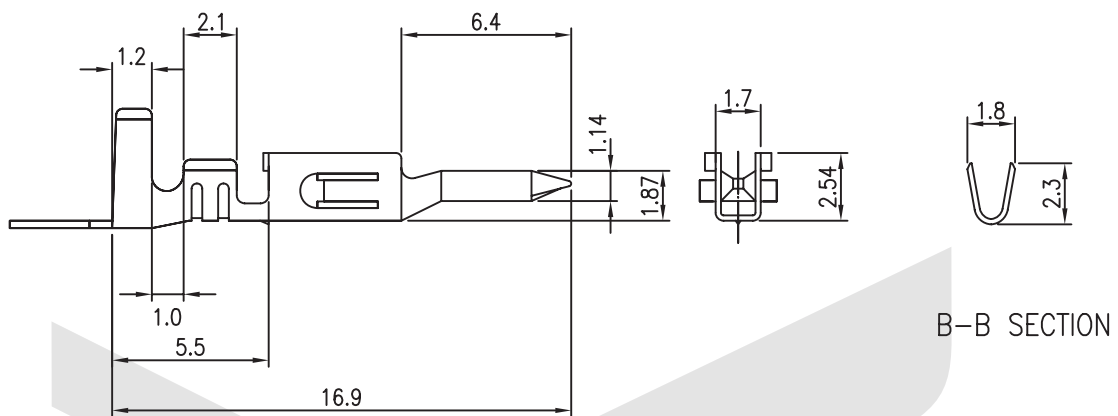
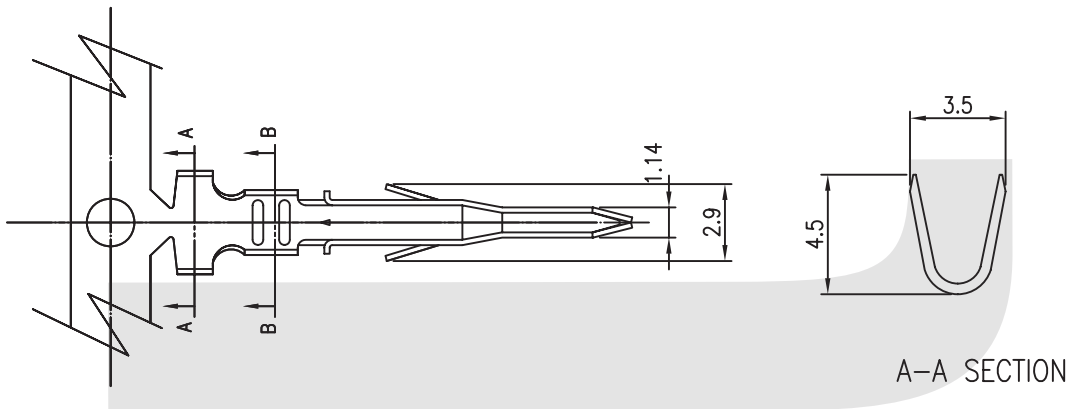

ORDER INFORMATION

Product NO.: KLS1-4.20 -MT

Pitch: 4.20=4.20mm

Type: MH=Male Housing FT=Female Terminal
 FH=Female Housing MT=Male Terminal
 S=Straight pin R=Right pin
 SW=Straight pin with Peg RW=Right pin with Peg
 SB=Straight pin Special Type RB=Right pin with Ears

PCB Connector Series

KLS1-4.20 Pitch=4.20mm TYPE

Electrical Specification:

Rated Voltage: 300V AC.DC
 Rated Current: 9A
 Contact Resistance: 0.015Ω max
 Insulation Resistance: 1000MΩ min
 Withstand voltage: 1500V AC/MIN
 Temperature range for usage: -40°C~+105°C

Material:

Housing: PA66 (PA66) UL94V-2
 Contacts: Brass
 Plating: Tin 50u" over 100u" nickel
 Wire range : AWG#30~#22

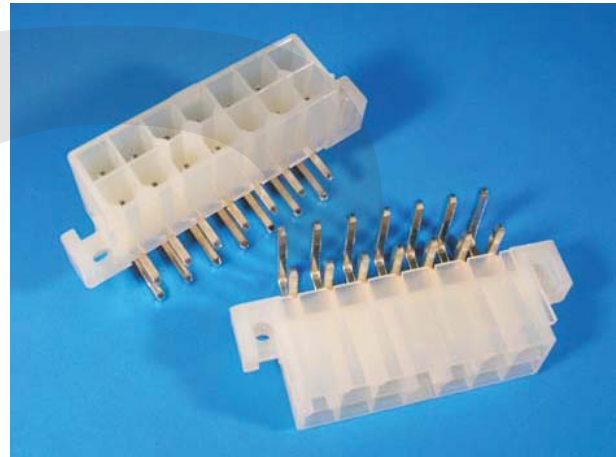

Double layer Right pin With Peg

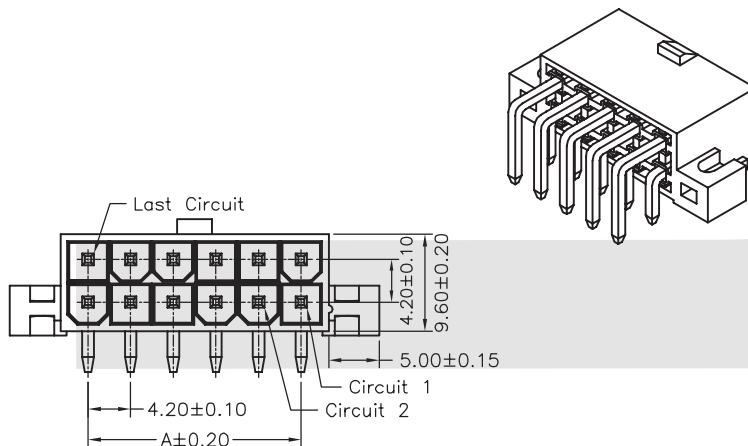

PART NO.	Dimensions	
	A	B
2X01	---	5.40
2X02	4.20	9.60
2X03	8.40	13.80
2X04	12.60	18.00
2X05	16.80	22.20
2X06	21.00	26.40
2X07	25.20	30.60
2X08	29.40	34.80
2X09	33.60	39.00
2X10	37.80	43.20
2X11	42.00	47.40
2X12	46.20	51.60

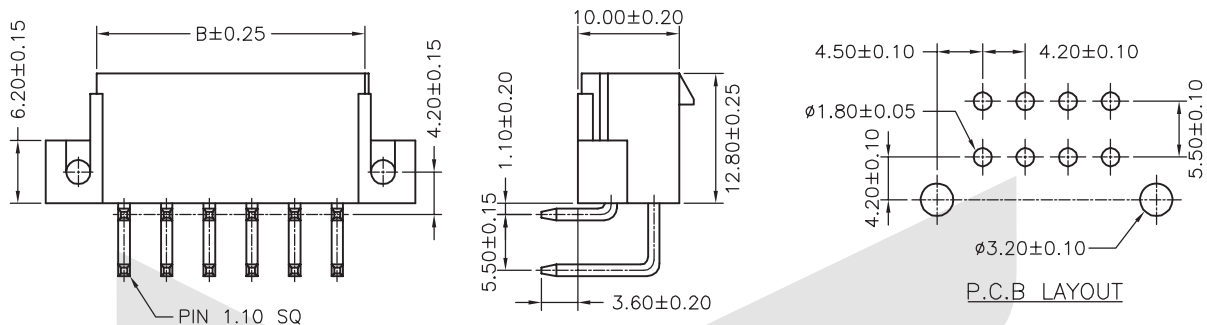

ORDER INFORMATION

Product NO.: KLS1-4.20 -2X05-RB

Pitch: 4.20=4.20mm
 Pins: 1-Single layer
 Pin Number: 2~12Pin

2-Double layer

Type: MH=Male Housing FT=Female Terminal
 FH=Female Housing MT=Male Terminal
 S=Straight pin R=Right pin
 SW=Straight pin with Peg RW=Right pin with Peg
 SB=Straight pin Special Type RB=Right pin with Ears

