

RECOMMEND P.C.B LAYOUT (COMPONENT SIDE)
TOLERANCE FOR PCB LAYOUT IS ±0.05
PCB THICKNESS=1.0mm

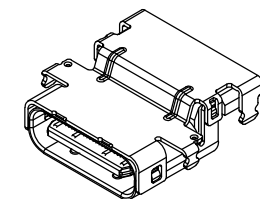
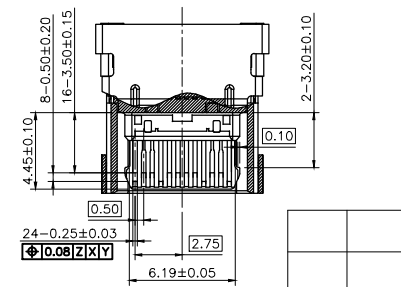
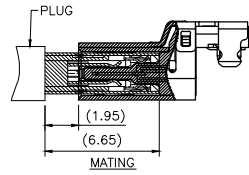
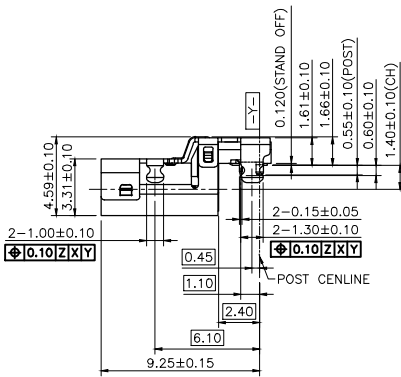
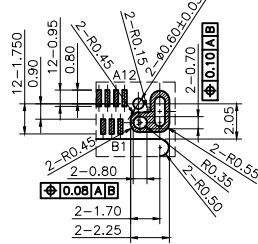

| 序号 No. | 变更内容 MODIFY CONTENT | 日期 MODIFY DATE | GENERAL TOLERANCE | | 制图 DRAWING | 审核 CHECK | 批准 APPROVAL | 比例 SCALE | 投影 Projection |
|--------|---------------------|----------------|-------------------|-------|------------|----------|-------------|----------|---------------|
| | | | DIM | TOL | | | | | |
| | | | X.X | ±0.30 | | | | | |
| | | | X.XX | ±0.20 | | | | | |
| | | | X.XXX | ±0.10 | | | | | |
| | | | Angle | ±3.0° | | | | | |

| 制 图 | | | |
|------------|--|--|--|
| DRAWING | | | |
| 审 核 | | | |
| CHECK | | | |
| 批 准 | | | |
| APPROVAL | | | |
| 比 例 | | | |
| SCALE | | | |
| 投 影 | | | |
| Projection | | | |

深圳市华灿天禄电子有限公司
Shenzhenhuacantiantu ELECTRONICS CO., LTD

| 产品名称 TITLE | TYPE CF 24P 沉板-1.40mm L9.92mm 带弹有柱 (USB4.0) | 版本 REV. | A |
|---------------|---|----------|-----|
| 产品料号 PART NO. | HC-TYPE-C-24P-MM_1.4-5A-12 | 单位 UNITS | mm |
| 材料 MATERIAL | | 页次 SHEET | 1/2 |

SPECIFICATION

- *ELECTRICAL
 - 1.CONTACT RESISTANCE:40mΩ MAX
 - 2.DIELECTRIC WITHSTANDING VOLTAGE:100V AC MAX
 - 3.INSULATION RESISTANCE:100MΩ MIN
- *MECHANICAL
 - 1.INSERTION FORCE AND EXTRACTION FORCE:
 - 1.1 INSERTION FORCE:5~20 N
 - 1.2 EXTRACTION FORCE :
 - INITIAL:8~20N
 - AFTER DURABILITY:6~20N
 - 2.DURABILITY: 10000 CYCLES.
- *MATERIAL
 - 1.HOUSING:THERMOPLASTIC, GLASS FIBER FILLED UL 94V-0 RATED
 - 2.CONTACT: COPPER ALLOY
 - 3.SHELL:STAINLESS

| USB TYPE-C PIN ASSIGNMENTS | | | |
|----------------------------|-------------|------------|-------------|
| PIN NUMBER | SIGNAL NAME | PIN NUMBER | SIGNAL NAME |
| A1 | GND | B12 | GND |
| A2 | SSTXP1 | B11 | SSRXP1 |
| A3 | SSTXN1 | B10 | SSRXN1 |
| A4 | VBUS | B9 | VBUS |
| A5 | CC1 | B8 | SBU2 |
| A6 | Dp1 | B7 | Dn2 |
| A7 | Dn1 | B6 | Dp2 |
| A8 | SBU1 | B5 | CC2 |
| A9 | VBUS | B4 | VBUS |
| A10 | SSRXN2 | B3 | SSTXN2 |
| A11 | SSRXP2 | B2 | SSTXP2 |
| A12 | GND | B1 | GND |

| P/N | L | COLOR | 额定电流 |
|----------------------------|--------|-------|------|
| HC-TYPE C-24P-MM 1.4-5A-12 | 9.92mm | 黑色 | 5A |

Ordering Information

HC-TYPE CM -24P - ** - *A - F* - * - 12

| | | | | | |
|-----|----------------------|---------|---------|-------------|---------|
| Pn | Type | Color | Current | Foot Length | Color |
| 4P | Mini-Top Mount (R/L) | 0-Black | 0-0.5A | 0-4.0mm | 0-Black |
| 6P | DS-DIP (SMT) | 0-Black | 0-0.5A | 0-4.0mm | 0-Black |
| 9P | Mini-Mid Mount (R/L) | 0-Black | 0-0.5A | 0-4.0mm | 0-Black |
| 12P | DS-DIP (SMT) | 0-Black | 0-0.5A | 0-4.0mm | 0-Black |
| 15P | DS-DIP (SMT) | 0-Black | 0-0.5A | 0-4.0mm | 0-Black |
| 18P | DS-DIP (SMT) | 0-Black | 0-0.5A | 0-4.0mm | 0-Black |
| 24P | DS-DIP (SMT) | 0-Black | 0-0.5A | 0-4.0mm | 0-Black |
| | FL=Flg | | | | |

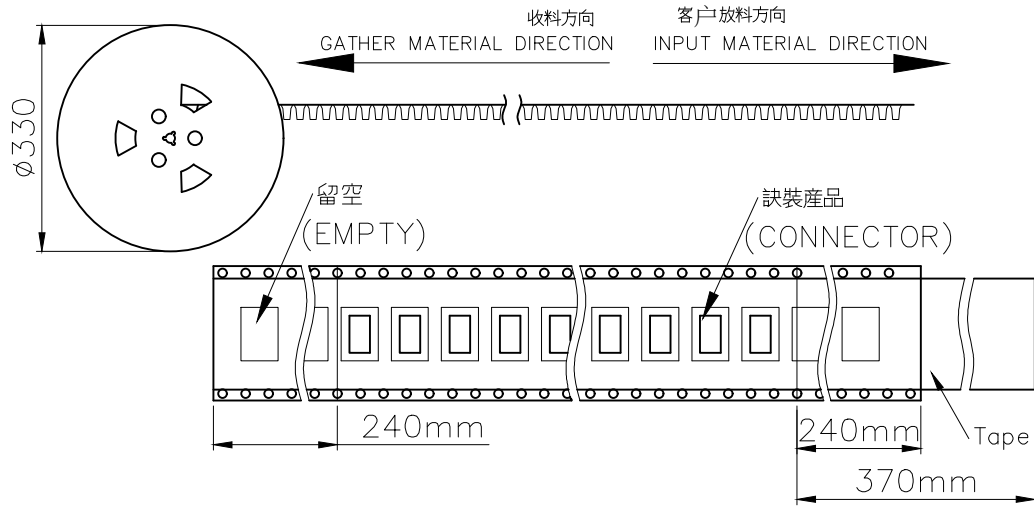

| | | |
|---------|-------------|---------|
| pcs/box | boxs/Carton | Pcs/Box |
| 750 | 10 | 7500 |

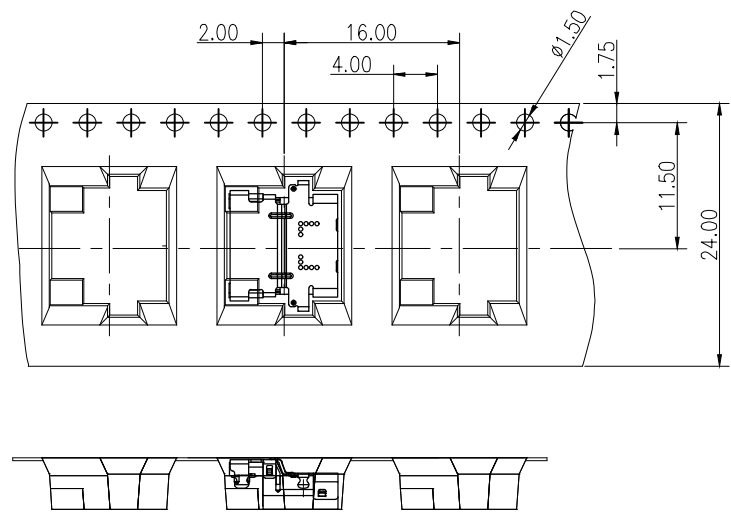
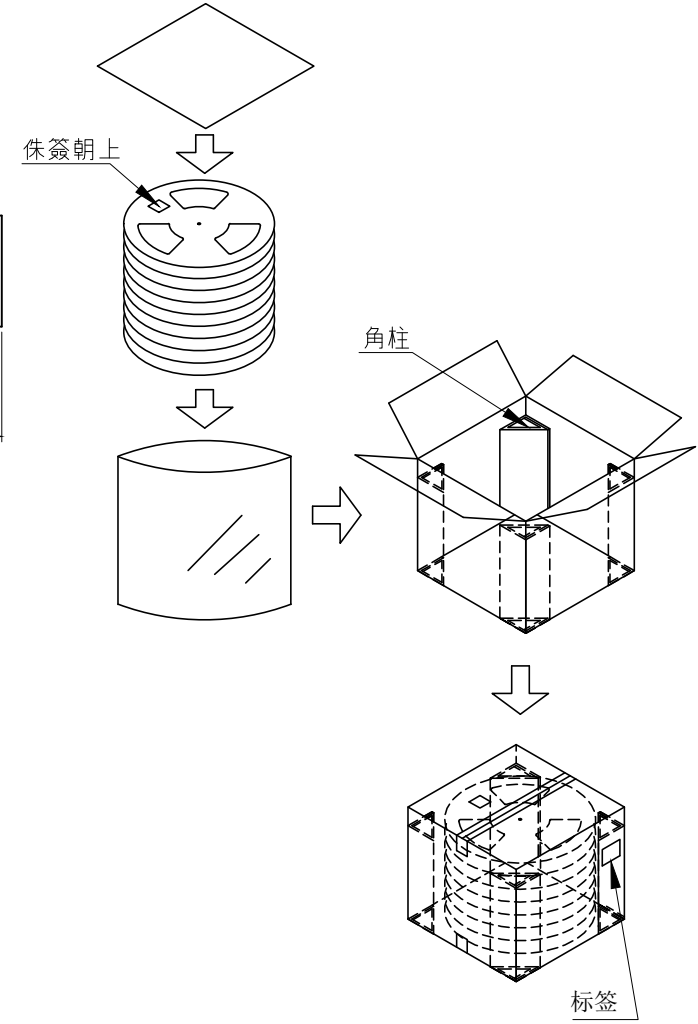

| | | | | | | | | |
|-----------|------------------------|-------------------|------------------|------------------|--|---|-------------|-----|
| | | | GENEAL TOLERANCE | 制图 DRAWING | 深圳市华灿天禄电子有限公司 ShenzhenhuacantianluELECTRONICS CO.,LTD | | | |
| | | | DIM TOL | 审核 CHECK | 产品名称 TITLE | TYPE CF 24P 沉板-1.40mm L9.92mm 带弹有柱 (USB4.0) | 版本 REV. | A |
| | | | X.X ±0.30 | 批准 APPROVAL | 产品料号 PART NO. | HC-TYPE C-24P-MM_1.4-5A-12 | 单位 UNITS | mm |
| | | | X.XX ±0.20 | 投影 Projection | 材料 MATERIAL | | 页次 SHEET | 2/2 |
| | | | X.XXX ±0.10 | | | | | |
| | | | Angle ±3.0° | | | | | |
| 1 | 初版发行 | | | | | | | |
| 序号 No. | 变更内容 MODIFY CONTENT | 日期 MODIFY DATE | | | | | | |