

5

4

3

2

1

D

C

B

A

Hood lower part

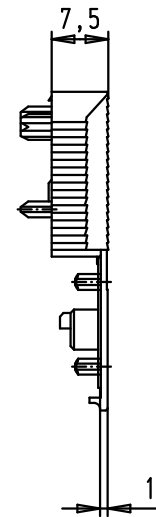
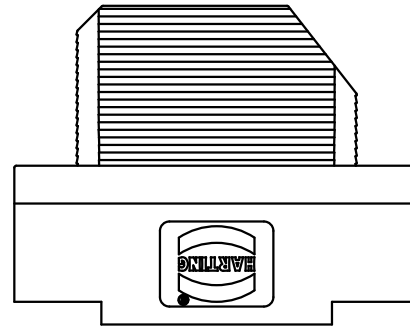
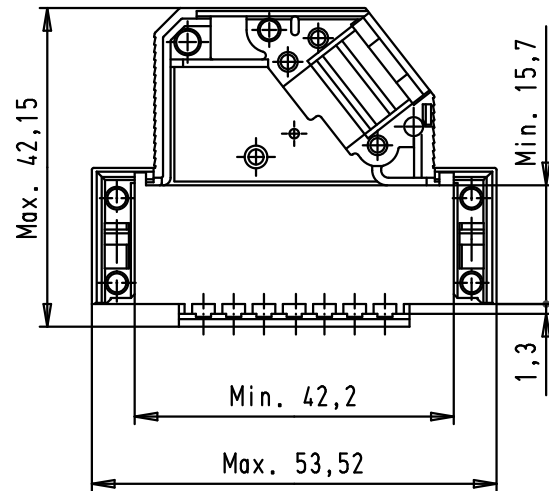
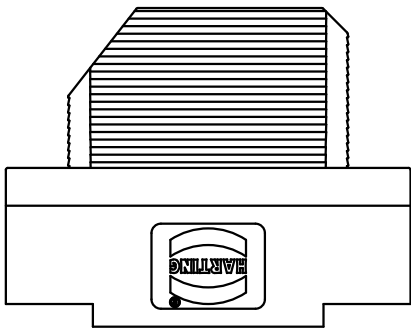

Hood upper part

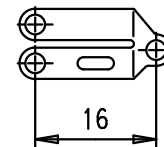
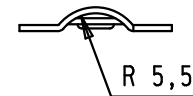
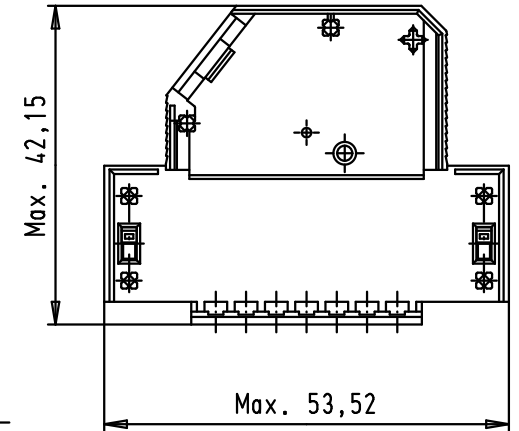

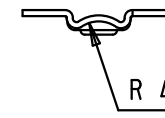
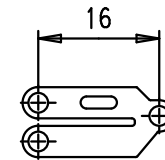

Strain relief 1

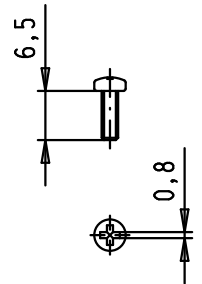

Strain relief 2

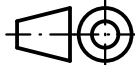

Flathead screws

Mod.	Dot.	Name	Dot.	Name	 All Dim. in mm Orig. Size DIN A 4	D-Sub hoods 25 poles not shielded	Maßstab/ Scale 1:1
EC01696	20/04/10	SC	Detail.	27/02/03 SH			
34793	09/01/08	PK	Insp.				
33806	26/09/06	PK	Stand.				
31392	27/02/03	SH	HARTING EURL F-95972 Paris			TB 09 67 025 0571	Blatt/ Page 1 / 1

Mouser Electronics

Authorized Distributor

Click to View Pricing, Inventory, Delivery & Lifecycle Information:

[HARTING:](#)

[09670250571](#)