



PANDUCT® Wiring Duct
SA-WDCB05 (replaces SA101N64D-LP)

Overview

New Products . . . . . A2
Part Number Nomenclature . . . . . A3

Control Panel

PANDUCT® Wiring Duct for Control Panel Applications Introduction . . . . . B1
Control Panel Applications Roadmap . . . . . B2-B3
Type G Wide Slot Wiring Duct . . . . . B4-B5
Type F Narrow Slot Wiring Duct . . . . . B6-B7
New Flush Cover Type D Round Hole Wiring Duct . . . . . B8-B9
Type MC Metric Narrow Slot Wiring Duct . . . . . B10-B11
New Type H Hinged Cover Wiring Duct . . . . . B12

Special Environment

PANDUCT® Wiring Duct for Special Environments Introduction . . . . . C1
Special Environments Selection Chart . . . . . C2-C3
New Type NNC Halogen Free Metric Wiring Duct . . . . . C4-C5
Type NE NORYL\* Halogen Free Wiring Duct . . . . . C6-C7
New Type TMC Low Smoke/Low Toxicity Wiring Duct . . . . . C8-C9

Voice & Data

PANDUCT® Wiring Duct for Communication Applications Introduction . . . . . D1
Communication Applications Roadmap . . . . . D2-D5
New Type H Hinged Cover Wiring Duct . . . . . D6-D7
Type FS Solid Wall Raceway . . . . . D8-D9
Type G Wide Slot Wiring Duct . . . . . D10
1" Bend Radius Corner Strips . . . . . D11
Bend Radius Control Trumpet . . . . . D11
TAK-TY® Hook & Loop Cable Ties . . . . . D12
New ULTRA-CINCH™ Hook & Loop Ties . . . . . D12
TAK-TAPE™ Hook & Loop Strips . . . . . D13
TAK-TY® Hook & Loop Cable Tie Mounts . . . . . D13
Cable Management Solutions for Network Racks . . . . . D14

Tools & Accessories

PANDUCT® Accessories and Installation Tools Introduction . . . . . E1
Accessories and Installation Tools Roadmap . . . . . E2-E3
New Type FL Flexible Wiring Duct . . . . . E4
Solid and Slotted Divider Wall . . . . . E5
Mounting Base . . . . . E6
Wire Retainers . . . . . E6-E7
Duct Corner Strips . . . . . E8
Duct Joining Strips . . . . . E8
Mounting Brackets and Fasteners . . . . . E9-E10
PAN-TY® Cable Ties . . . . . E10
4-Way Adhesive Backed Mounts . . . . . E11
Tie Mounts — Mechanically Applied . . . . . E11
Tie Anchor Mounts — Screw Applied . . . . . E12
Low Profile Mounts — Screw Applied . . . . . E12
Adhesive Tape . . . . . E12-E13
Duct Cutting Tool . . . . . E14
Duct Finger Cutting Tool . . . . . E14
Duct Notching Tool . . . . . E15
Nylon Rivet Installation Tool . . . . . E15

Technical Info

Dimensions and Information . . . . . F1-F7
Wirefill Capacity . . . . . F8-F11
Material Specifications . . . . . F12-F13
Color Selection Guide . . . . . F14
Installation Tips . . . . . F15
Explanation of Agency Approvals and Standards . . . . . F15-F16

Index

Alphanumeric Part Number Index . . . . . G1-G5

\*NORYL is a registered trademark of General Electric Company.

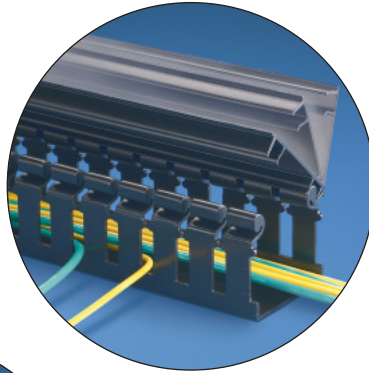
**NEW!****Wiring Duct  
from PANDUIT®****Type H – Hinged Cover  
Wiring Duct**

Designed for wire management applications where frequent moves, adds, changes or equipment upgrades require repeated, easy and quick access to duct channel.

See [pages B12, D6 & D7](#) for details.

**Type FL – Flexible Wiring Duct**

Designed to route and protect wires installed in control panel applications that require flexibility.

See [page E4](#) for details.

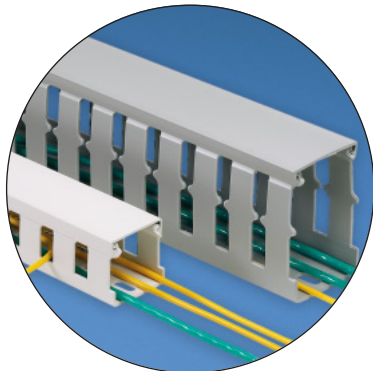
**Type NNC – Halogen Free Metric Wiring Duct**

Designed for panel applications where high temperatures or halogen free requirements exist.

See [pages C4-C5](#) for details.

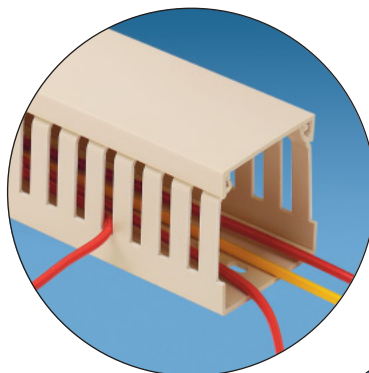
**Type TMC – Low Smoke/Low Toxicity  
Wiring Duct**

Designed for wire management applications in public transportation.

See [pages C8-C9](#) for details.

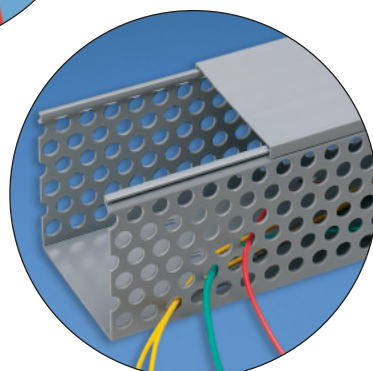
**Flush Cover Type D – Round  
Hole Wiring Duct**

Improved profile design provides greater wirefill capacity.

See [pages B8-B9](#) for details.

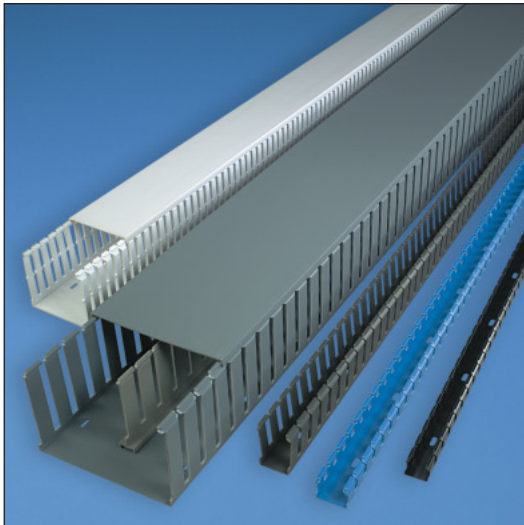

For over 45 years, **PANDUIT®** has been the world leader in the design and manufacture of wiring duct in a wide selection of sizes, styles, colors and materials. The **PANDUIT®** name has become synonymous with high quality, innovative wiring duct products used to route, protect and conceal wiring in a wide variety of industrial control and telecommunications applications. **PANDUIT®** continues to develop new wiring duct solutions to satisfy the wire management challenges facing our customers worldwide.

## Wiring Duct Functional Part Number System Makes Ordering Easy

<b>G</b>	<b>.5</b>	<b>X</b>	<b>.5</b>	<b>LG</b>	<b>6</b>	<b>-A</b>
Type/Style	Nominal Width In. or mm		Nominal Height In. or mm	Color	Length Ft. or M	-A = Adhesive Backed = Without Adhesive (leave blank) NM = No Mounting Holes
G = Wide Finger Flush Design				LG = Light Gray		
F = Narrow Finger Flush Design				DG = Dark Gray		
FS = Solid Wall Flush Design				WH = White		
H = Wide Finger Hinged Design				BL = Black		
D = Round Hole Flush Design				IB = Intrinsic Blue		
NNC = Halogen Free Design				BR = Beige		
NE = <i>NORYL</i> * Wide Finger Design				IG = International Grey		
MC = Metric Narrow Finger Design						
TMC = Low Smoke Metric Design						

Note: See **page F12** for UL94 requirements.

\**NORYL* is a registered trademark of General Electric Company.

Overview

# Wiring Duct *Overview*

## **Notes**

Control  
Panel

Special  
Environment

Voice &  
Data

Tools &  
Accessories

Technical  
Info

Index

## Wiring Duct for Control Panel Applications

*PANDUCT® Wiring Duct is the premium wire management solution for routing and concealing wiring in control panels. A wide variety of sizes are available to meet the wire capacity needs and space constraints of the smallest wall mounted panels to the largest integrated systems. In addition, five innovative wiring duct styles accommodate a variety of specification requirements, control panel designs and post-installation needs.*

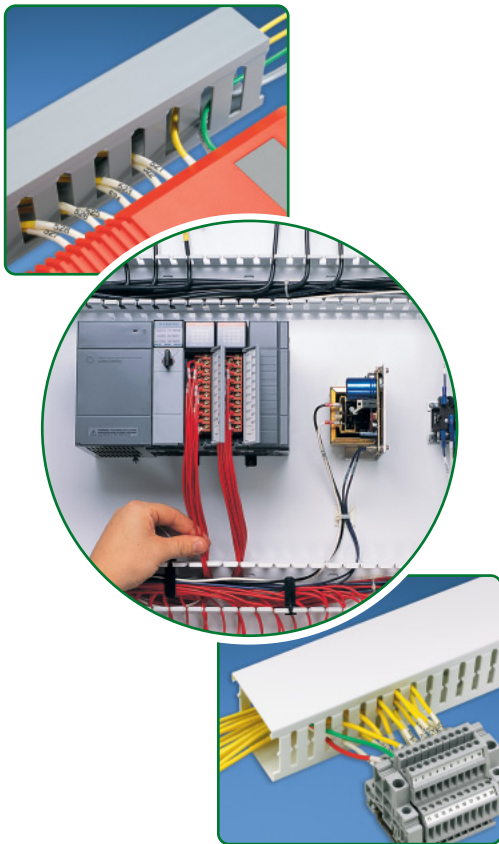

Some of the features and benefits found in all PANDUCT® Wiring Duct types include:

- Smooth corners and edges will not abrade wiring or irritate hands
- Integrated nonskid liner and unique cover designs insure the duct cover will not slide once installed or during vibration
- UL Recognized as meeting the requirements of UL Standard 1565 for Positioning Devices
- CE compliant for panels that are to be exported to Europe
- Specially formulated PVC material meets the NFPA79: 2002 flame retardancy requirements for nonmetallic duct in industrial equipment
- PVC material carries a UL94 flammability rating of V-0 for excellent flame retardancy

Overview

Control Panel

Special Environment

Voice & Data

Tools & Accessories

Technical Info

Index



# Wiring Duct for Control Panel Applications

Overview

Control Panel

Special Environment

Voice & Data

Tools & Accessories

Technical Info

Index

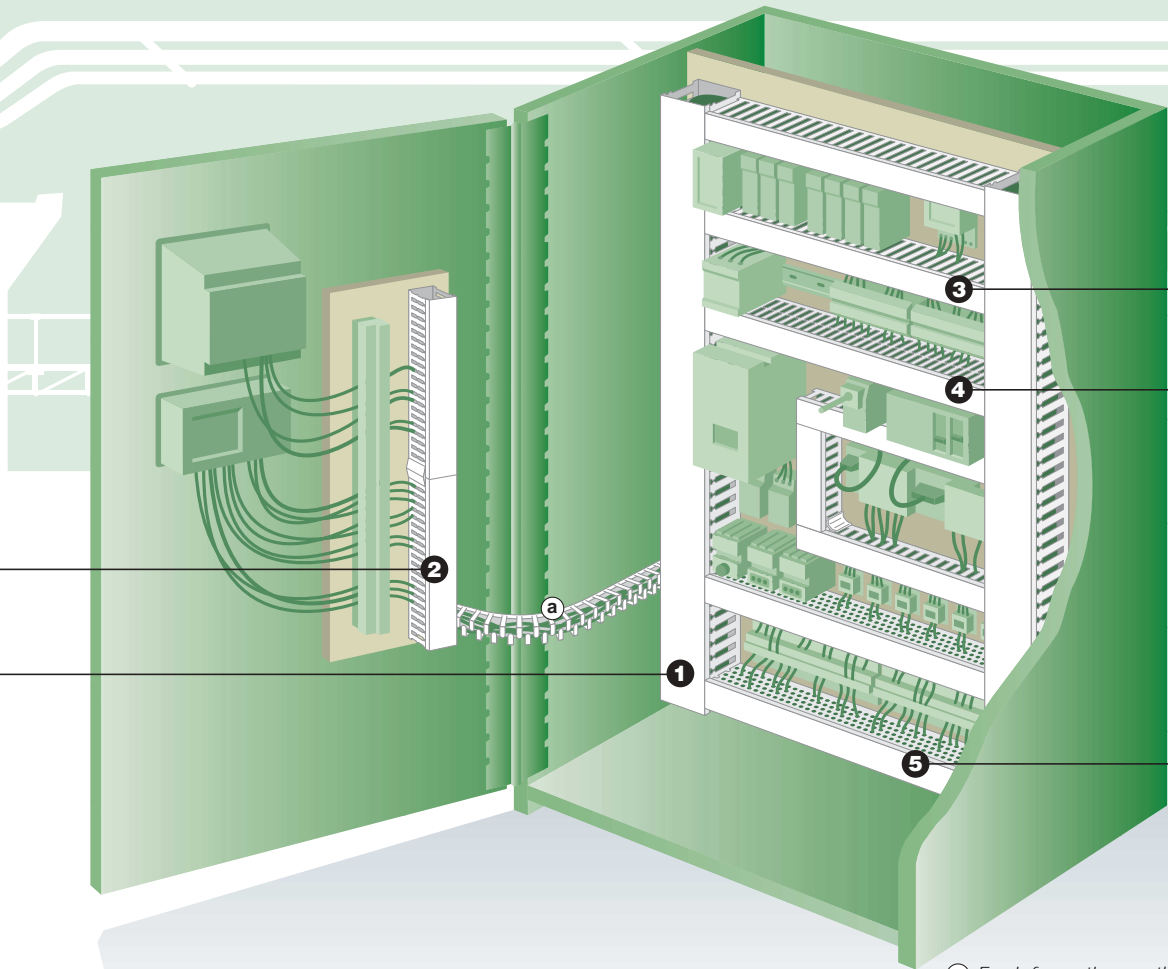

## 1 Type H Hinged Cover Wiring Duct

PAGE B12

<sup>a</sup> For information on the complete line of PANDUCT® Accessories see page E1

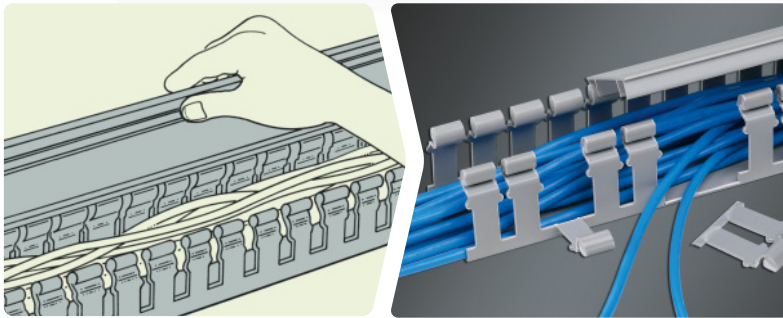

**NEW!**

Duct cover hinges open, providing easy access to cabling without the need to remove the cover. Ideal for applications with frequent moves, adds and changes.

## 2 Type F Narrow Slot Wiring Duct

PAGES B6/B7

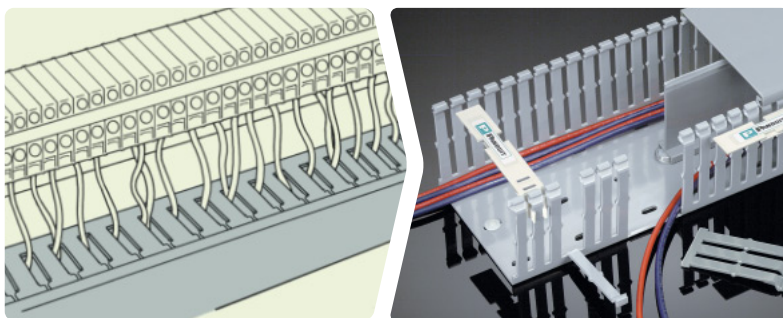

Narrow finger and slot design for high-density terminal blocks. Restricted slots retain conductors.

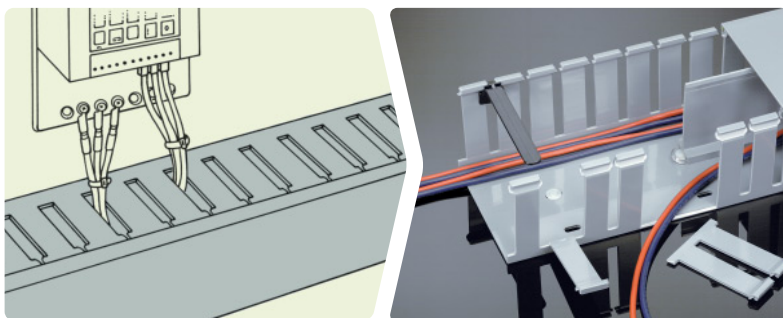
**3 Type G Wide Slot Wiring Duct**PAGES **B4/B5**

Wide finger and slot design allows both single conductors and small cable bundles to be easily transitioned from the channel. Fits a wide variety of applications.

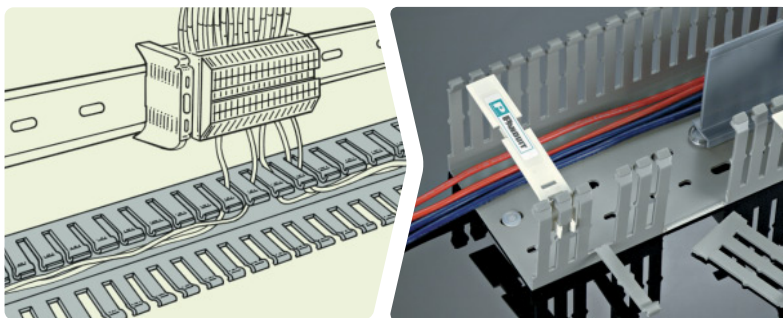
**4 Type MC Metric Wiring Duct**PAGES **B10/B11**

Narrow finger and slot design for high-density terminal blocks. Metric sizing with DIN style mounting hole pattern meets European specifications.

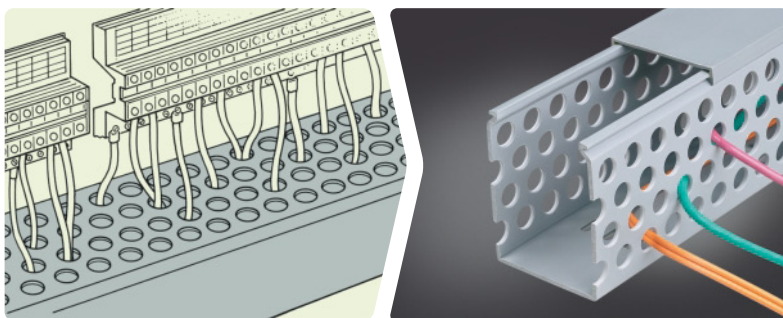
**5 Type D Flush Cover Round Hole Wiring Duct**PAGES **B8/B9****NEW DESIGN!**

Round hole design allows the positioning of wires at various heights when transitioning from the duct. Flush cover design for increased capacity and superior aesthetics.

# Wiring Duct *Control Panel*

## PANDUCT® Type G — Wide Slot Wiring Duct

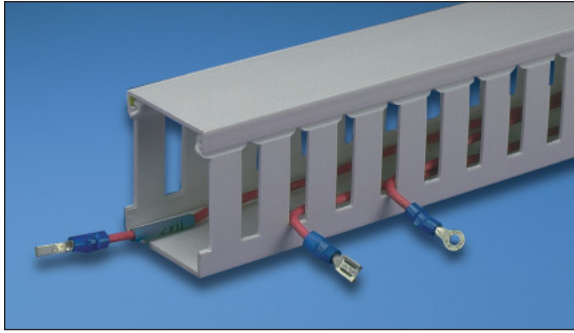

- Wide slot/finger design provides greater sidewall rigidity and can be used with a wide range of wire bundle sizes
- Made of rigid PVC
- UL Recognized continuous use temperature: 50°C (122°F)
- UL94 Flammability Rating of V-0
- Provided with mounting holes
- Conforms with NFPA 79-2002 section 14.3.1 requirement for flame retardant material



- nonmetallic, non-flame propagating CDS
- medium impact resistance
- 331 temperature classification
- cover removal without tools

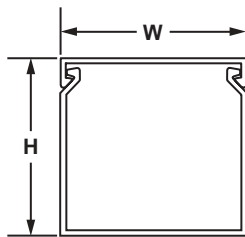

Part Number	Duct Size W x H		Cover Part Number	Duct Std. Ctn. Qty.	Cover Std. Ctn. Qty.	Length (ft)
	In.	mm				
G.5X.5LG6	.69 x .60	17.5 x 15.2	C.5LG6	120	120	6
G.5X1LG6	.69 x 1.06	17.5 x 26.9		120		
G.5X2LG6	.69 x 2.03	17.5 x 51.6		120		
G.5X4LG6	.69 x 4.10	17.5 x 104.1		60		
G.75X.75LG6	.93 x .82	23.6 x 20.8	C.75LG6	120	120	6
G.75X1LG6	.93 x 1.06	23.6 x 26.9		120		
G.75X1.5LG6	.93 x 1.57	23.6 x 39.9		120		
G.75X2LG6	.93 x 2.03	23.6 x 51.6		120		
G1X1LG6	1.26 x 1.12	32.0 x 28.4	C1LG6	120	120	6
G1X1.5LG6	1.26 x 1.62	32.0 x 41.1		120		
G1X2LG6	1.26 x 2.12	32.0 x 53.8		120		
G1X3LG6	1.26 x 3.12	32.0 x 79.2		120		
G1X4LG6	1.26 x 4.10	32.0 x 104.1		60		
G1.5X1LG6	1.75 x 1.12	44.5 x 28.4	C1.5LG6	120	120	6
G1.5X1.5LG6	1.75 x 1.62	44.5 x 41.1		120		
G1.5X2LG6	1.75 x 2.12	44.5 x 53.8		120		
G1.5X3LG6	1.75 x 3.12	44.5 x 79.2		120		
G1.5X4LG6	1.75 x 4.10	44.5 x 104.1		60		
G2X1LG6	2.25 x 1.12	57.2 x 28.4	C2LG6	120	120	6
G2X1.5LG6	2.25 x 1.62	57.2 x 41.1		120		
G2X2LG6	2.25 x 2.12	57.2 x 53.8		120		
G2X3LG6	2.25 x 3.12	57.2 x 79.2		60		
G2X4LG6	2.25 x 4.10	57.2 x 104.1		60		
G2X5LG6	2.25 x 5.10	57.2 x 129.5		60		
G2.5X3LG6	2.75 x 3.12	69.9 x 79.2	C2.5LG6	120	120	6
G3X1LG6	3.25 x 1.12	82.6 x 28.4	C3LG6	120	120	6
G3X2LG6	3.25 x 2.12	82.6 x 53.8		120		
G3X3LG6	3.25 x 3.12	82.6 x 79.2		60		
G3X4LG6	3.25 x 4.10	82.6 x 104.1		60		
G3X5LG6	3.25 x 5.10	82.6 x 129.5		60		
G4X1.5LG6	4.25 x 1.62	108.0 x 41.1	C4LG6	120	120	6
G4X2LG6	4.25 x 2.12	108.0 x 53.8		60		
G4X3LG6	4.25 x 3.12	108.0 x 79.2		60		
G4X4LG6	4.25 x 4.10	108.0 x 104.1		60		
G4X5LG6	4.25 x 5.10	108.0 x 129.5		60		
G6X4LG6	6.25 x 4.15	158.8 x 105.4	C6LG6	60	120	6

Part Number shown for LG (Light Gray). For other color availability see Color Selection Guide, [page F14](#).

Reference	Page(s)
Color Availability	<b>F14</b>
Adhesive Tape	<b>E12, E13</b>
Dimensions	<b>F2</b>
Wirefill Guide	<b>F8</b>
Material Specifications	<b>F13</b>
Tools & Accessories	<b>D11, D12, Section E</b>
Installation Tips	<b>F15</b>



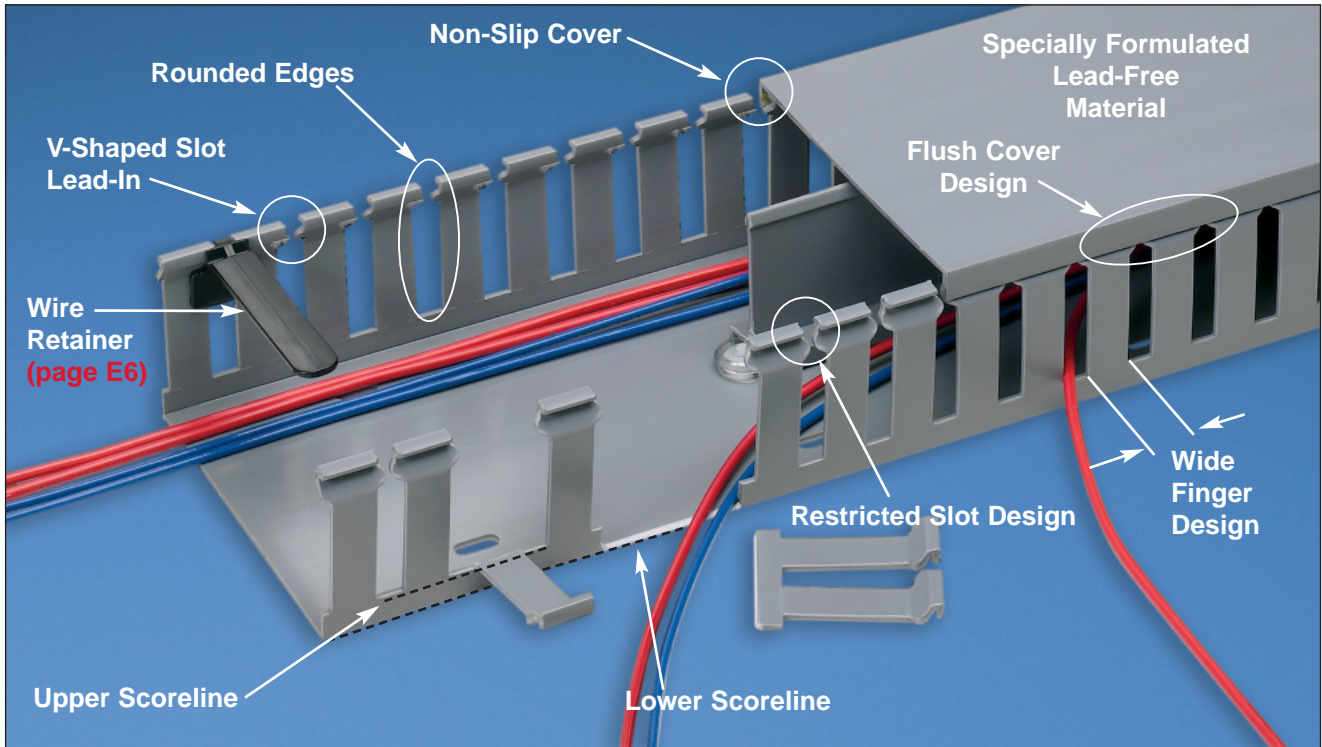

Features	Advantages	Benefits
Wide finger and slot design	Greater rigidity and larger slot width	Can be used with a wide range of wire and bundle sizes
Smooth rounded edges	Exclusive <i>PANDUIT</i> ® process rounds the edges in duct slots and at top of duct fingers	Protects hands and wiring/cabling from abrasion
Non-slip cover (co-extruded non-slip liner inside duct covers)	Will not slide easily when installed on duct base	Cover stays in place during shipment, vibration and when in a vertical orientation, eliminating rework
Flush cover design	Greater capacity than traditional duct designs Cover sits flush with sidewall	Can potentially use a smaller size wiring duct for same number of wires Provides a neat and finished appearance
Double scoreline	Upper scoreline at base of finger allows fingers to be broken out without tools Lower scoreline at base of duct allows sidewall sections to be removed	Allows quick modification for larger cabling bundles saving installation time leading to a lower installed cost Easier to create tee and corner junctions with full wire carrying capacity
Specially formulated material	Lead-free Provides a smooth burr-free edge when sidewalls or fingers are broken out	Eliminates health concerns associated with PVC that contains lead Eliminates the need to deburr saving installation time
V-shaped slot lead-in	V-shape funnels wires into slot for easier insertion	Speeds wire installation
Restricted slot design	Once inserted wires are retained in the slot with or without the cover being installed	Eliminates hassle and saves time during installation and maintenance

Overview

Control Panel

Special Environment

Voice & Data

Tools & Accessories

Technical Info

Index

# Wiring Duct *Control Panel*

## PANDUCT® Type F — Narrow Slot Wiring Duct

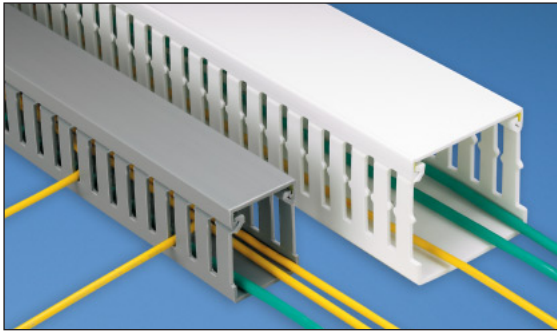

- Narrow slot/finger design provides more slots to closer fit the spacing of high-density terminal blocks and other hardware
- Made of rigid PVC
- UL Recognized continuous use temperature: 50°C (122°F)
- UL94 Flammability Rating of V-0
- Provided with mounting holes
- Conforms with NFPA 79-2002 section 14.3.1 requirement for flame retardant material



- nonmetallic, non-flame propagating CDS
- medium impact resistance
- 331 temperature classification
- cover removal without tools

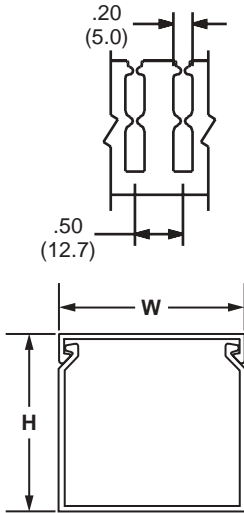

Reference	Page(s)
Color Availability	<b>F14</b>
Adhesive Tape	<b>E12, E13</b>
Dimensions	<b>F3</b>
Wirefill Guide	<b>F8</b>
Material Specifications	<b>F13</b>
Tools & Accessories	<b>Section E</b>
Installation Tips	<b>F15</b>

Part Number	Duct Size W x H		Cover Part Number	Duct Std. Ctn. Qty.	Cover Std. Ctn. Qty.	Length (ft)
	In.	mm				
F.5X.5LG6	.69 x .60	17.5 x 15.2	C.5LG6	120	120	6
F.5X1LG6	.69 x 1.06	17.5 x 26.9		120		
F.75X.75LG6	.93 x .82	23.6 x 20.8	C.75LG6	120	120	6
F.75X1.5LG6	.93 x 1.57	23.6 x 39.9		120		
F1X1LG6	1.26 x 1.12	32.0 x 28.4	C1LG6	120	120	6
F1X1.5LG6	1.26 x 1.62	32.0 x 41.1		120		
F1X2LG6	1.26 x 2.12	32.0 x 53.8		120		
F1X3LG6	1.26 x 3.12	32.0 x 79.2		120		
F1X4LG6	1.26 x 4.10	32.0 x 104.1		60		
F1.5X1LG6	1.75 x 1.12	44.5 x 28.4	C1.5LG6	120	120	6
F1.5X1.5LG6	1.75 x 1.62	44.5 x 41.1		120		
F1.5X2LG6	1.75 x 2.12	44.5 x 53.8		120		
F1.5X3LG6	1.75 x 3.12	44.5 x 79.2		120		
F1.5X4LG6	1.75 x 4.10	44.5 x 104.1		60		
F2X1LG6	2.25 x 1.12	57.2 x 28.4	C2LG6	120	120	6
F2X1.5LG6	2.25 x 1.62	57.2 x 41.1		120		
F2X2LG6	2.25 x 2.12	57.2 x 53.8		120		
F2X3LG6	2.25 x 3.12	57.2 x 79.2		60		
F2X4LG6	2.25 x 4.10	57.2 x 104.1		60		
F2X5LG6	2.25 x 5.10	57.2 x 129.5		60		
F3X1LG6	3.25 x 1.12	82.6 x 28.4	C3LG6	120	120	6
F3X2LG6	3.25 x 2.12	82.6 x 53.8		120		
F3X3LG6	3.25 x 3.12	82.6 x 79.2		60		
F3X4LG6	3.25 x 4.10	82.6 x 104.1		60		
F3X5LG6	3.25 x 5.10	82.6 x 129.5		60		
F4X2LG6	4.25 x 2.12	108.0 x 53.8	C4LG6	60	120	6
F4X3LG6	4.25 x 3.12	108.0 x 79.2		60		
F4X4LG6	4.25 x 4.10	108.0 x 104.1		60		
F4X5LG6	4.25 x 5.10	108.0 x 129.5		60		

Part Number shown for LG (Light Gray). For other color availability see Color Selection Guide, [page F14](#).

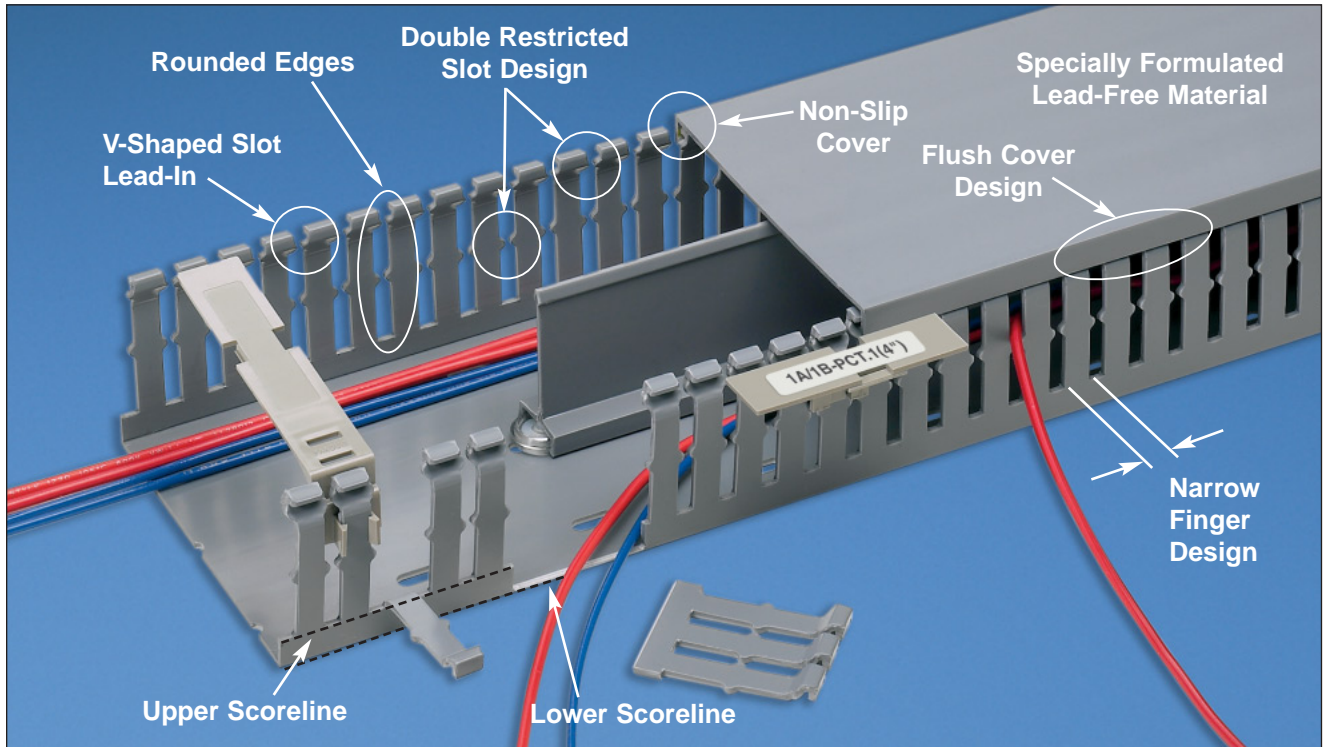

Features	Advantages	Benefits
Narrow finger and slot design	Provides closer spacing for use with high-density applications	Allows further fanning of wires for neater wire management in high-density control panels
Smooth rounded edges	Exclusive PANDUIT® process rounds the edges in duct slots and at top of duct fingers	Protects hands and wiring/cabling from abrasion
Non-slip cover (co-extruded non-slip liner inside duct covers)	Will not slide easily when installed on duct base	Cover stays in place during shipment, vibration and when in a vertical orientation, eliminating rework
Flush cover design	Greater capacity than traditional duct designs Cover sits flush with sidewall	Can potentially use a smaller size wiring duct for same number of wires Provides a neat and finished appearance
Double scoreline	Upper scoreline at base of finger allows fingers to be broken out without tools Lower scoreline at base of duct allows complete side wall sections to be removed	Allows quick modification for larger cabling bundles saving installation time leading to a lower installed cost Easier to create tee and corner junctions with full wire carrying capacity
Specially formulated material	Lead-free Provides a smooth burr-free edge when sidewalls or fingers are broken out	Eliminates health concerns associated with PVC that contains lead Eliminates the need to deburr saving installation time
V-shaped slot lead-in	V-shape funnels wires into slot for easier insertion	Speeds wire installation
Double restricted slot design	Once inserted wires are retained in the slot with or without the cover being installed Second restriction retains cabling within top or bottom portion of slot in larger wiring duct sizes	Eliminates hassle and saves time during installation and maintenance Provides a neat and finished appearance

Overview

Control Panel

Special Environment

Voice & Data

Tools & Accessories

Technical Info

Index

# Wiring Duct *Control Panel*

## **NEW DESIGN!** PANDUCT® Type D — Flush Cover Round Hole Wiring Duct

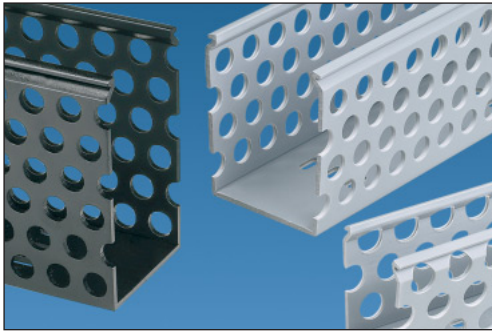

- Round hole design has multiple rows of holes to retain and support wire at variable heights and positions
- Made of rigid PVC
- UL Recognized continuous use temperature: 50°C (122°F)
- UL94 Flammability Rating of V-0
- Provided with mounting holes
- Conforms with NFPA 79-2002 section 14.3.1 requirement for flame retardant material



- nonmetallic, non-flame propagating CDS
- medium impact resistance
- 331 temperature classification
- cover removal without tools

Part Number	Duct Size W x H		Cover Part Number	Duct Std. Ctn. Qty.	Cover Std. Ctn. Qty.	Length (ft)
	In.	mm				
D1X2LG6	1.26 x 2.12	32.0 x 53.8	C1LG6	120	120	6
D1X3LG6	1.26 x 3.12	32.0 x 79.2		120		
D1X4LG6	1.26 x 4.10	32.0 x 104.1		60		
D1.5X2LG6	1.75 x 2.12	44.5 x 53.8	C1.5LG6	120	120	6
D1.5X3LG6	1.75 x 3.12	44.5 x 79.2		120		
D1.5X4LG6	1.75 x 4.10	44.5 x 104.1		60		
D2X2LG6	2.25 x 2.12	57.2 x 53.8	C2LG6	120	120	6
D2X3LG6	2.25 x 3.12	57.2 x 79.2		60		
D2X4LG6	2.25 x 4.10	57.2 x 104.1		60		
D2.5X3LG6	2.75 x 3.12	69.9 x 79.2	C2.5LG6	120	120	6
D3X2LG6	3.25 x 2.12	82.6 x 53.8	C3LG6	120	120	6
D3X3LG6	3.25 x 3.12	82.6 x 79.2		60		
D3X4LG6	3.25 x 4.10	82.6 x 104.1		60		
D4X2LG6	4.25 x 2.12	108.0 x 53.8	C4LG6	60	120	6
D4X3LG6	4.25 x 3.12	108.0 x 79.2		60		
D4X4LG6	4.25 x 4.10	108.0 x 104.1		60		

Part Number shown for LG (Light Gray). For other color availability see Color Selection Guide, [page F14](#).

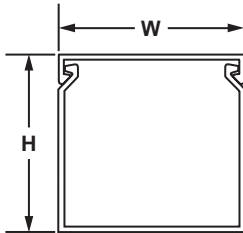

Reference	Page(s)
Color Availability	<a href="#">F14</a>
Adhesive Tape	<a href="#">E12</a>
Dimensions	<a href="#">F2</a>
Wirefill Guide	<a href="#">F8</a>
Material Specifications	<a href="#">F13</a>
Tools & Accessories	<a href="#">Section E</a>
Installation Tips	<a href="#">F15</a>

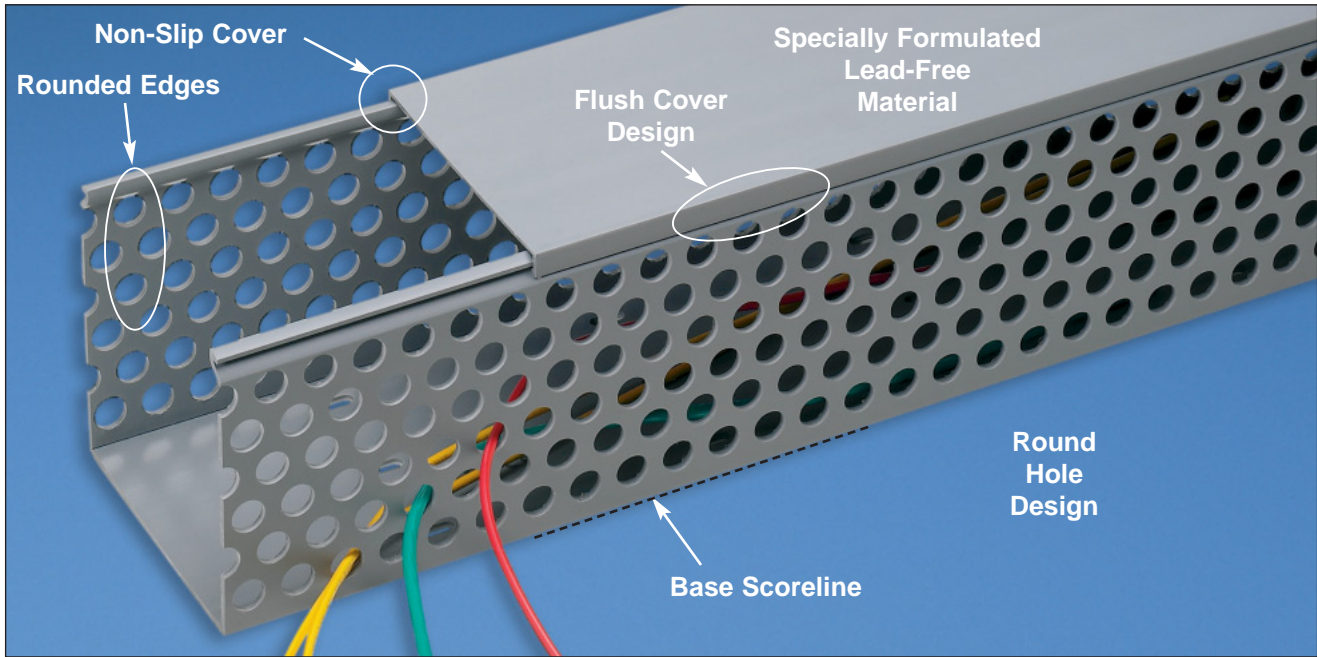

Features	Advantages	Benefits
Round hole design	Retains and supports wires at variable heights and positions with or without the cover installed	Superior aesthetics and wire management
Flush cover design	Greater capacity than traditional duct designs Cover sits flush with sidewall	Can potentially use a smaller size wiring duct for same number of wires Provides a neat and finished appearance
Non-slip cover (co-extruded non-slip liner inside duct covers)	Will not slide easily when installed on duct base	Cover stays in place during shipment, vibration and when in a vertical orientation, eliminating rework
Smooth rounded edges	Exclusive <i>PANDUIT</i> ® process rounds the edges of punched holes	Protects hands and wiring/cabling from abrasion
Specially formulated material	Lead-free Provides a smooth burr-free edge when sidewalls are broken out	Eliminates health concerns associated with PVC that contains lead Eliminates the need to deburr saving installation time
Base scoreline	Scoreline at base of duct allows sidewall sections to be removed	Easier to create tee and corner junctions with full wire carrying capacity

Overview

Control Panel

Special Environment

Voice & Data

Tools & Accessories

Technical Info

Index

# Wiring Duct *Control Panel*

## PANDUCT® Type MC — Metric Narrow Slot Wiring Duct

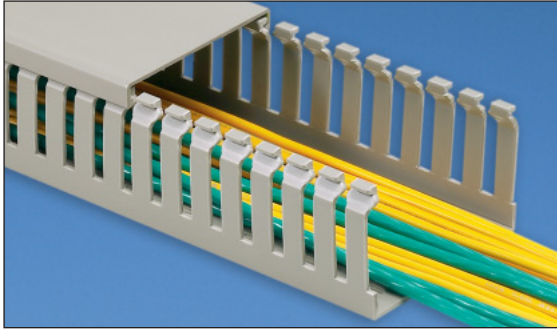

- CE compliant and metric sizing for control panels intended for European applications
- Made of rigid PVC
- UL Recognized continuous use temperature: 50°C (122°F)
- UL94 Flammability Rating of V-0
- Provided with DIN 43 659 mounting holes
- Duct and cover packaged together in 2 meter lengths
- Conforms with NFPA 79-2002 section 14.3.1 requirement for flame retardant material



- nonmetallic, non-flame propagating CDS
- medium impact resistance
- 331 temperature classification
- cover removal without tools

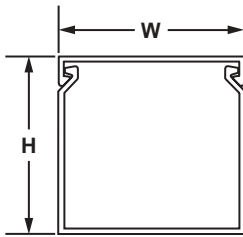
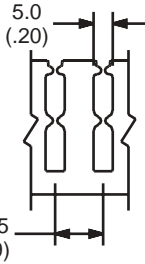

Reference	Page(s)
Color Availability	<b>F14</b>
Adhesive Tape	<b>E12</b>
Dimensions	<b>F4</b>
Wirefill Guide	<b>F9</b>
Material Specifications	<b>F13</b>
Tools & Accessories	<b>Section E</b>
Installation Tips	<b>F15</b>

Part Number	Duct Size W x H		Replacement Cover Part Number	Duct Std. Ctn. Qty.	Cover Std. Ctn. Qty.	Length (M)
	mm	In.				
MC25X25IG2	24.6 x 23.6	.97 x .93	C25IG2	20	20	2
MC25X37IG2	24.6 x 35.8	.97 x 1.41		20		
MC25X50IG2	24.6 x 47.8	.97 x 1.88		20		
MC25X62IG2	24.6 x 59.7	.97 x 2.35		20		
MC25X75IG2	24.6 x 72.4	.97 x 2.85		20		
MC37X37IG2	37.1 x 35.8	1.46 x 1.41	C37IG2	20	20	2
MC37X50IG2	37.1 x 47.8	1.46 x 1.88		20		
MC37X62IG2	37.1 x 59.7	1.46 x 2.35		20		
MC37X75IG2	37.1 x 72.4	1.46 x 2.85	20	20	2	
MC50X50IG2	49.5 x 47.8	1.95 x 1.89	10			
MC50X75IG2	49.5 x 72.4	1.95 x 2.85	10			
MC50X100IG2	49.5 x 97.8	1.95 x 3.85	10	20	2	
MC62X37IG2	62.0 x 35.8	2.44 x 1.41	20			
MC62X62IG2	62.0 x 59.7	2.44 x 2.35	20	20	2	
MC75X50IG2	74.7 x 48.0	2.94 x 1.89	20			
MC75X62IG2	74.7 x 59.7	2.94 x 2.35	20	20	2	
MC75X75IG2	74.7 x 72.4	2.94 x 2.85	10			
MC75X100IG2	74.7 x 97.8	2.94 x 3.85	10			
MC100X50IG2	99.6 x 48.0	3.92 x 1.89	10	20	2	
MC100X62IG2	99.6 x 59.7	3.92 x 2.35	10			
MC100X75IG2	99.6 x 72.4	3.92 x 2.85	10			
MC100X100IG2	99.6 x 97.8	3.92 x 3.85	10			

Available in IG (International Gray) only.

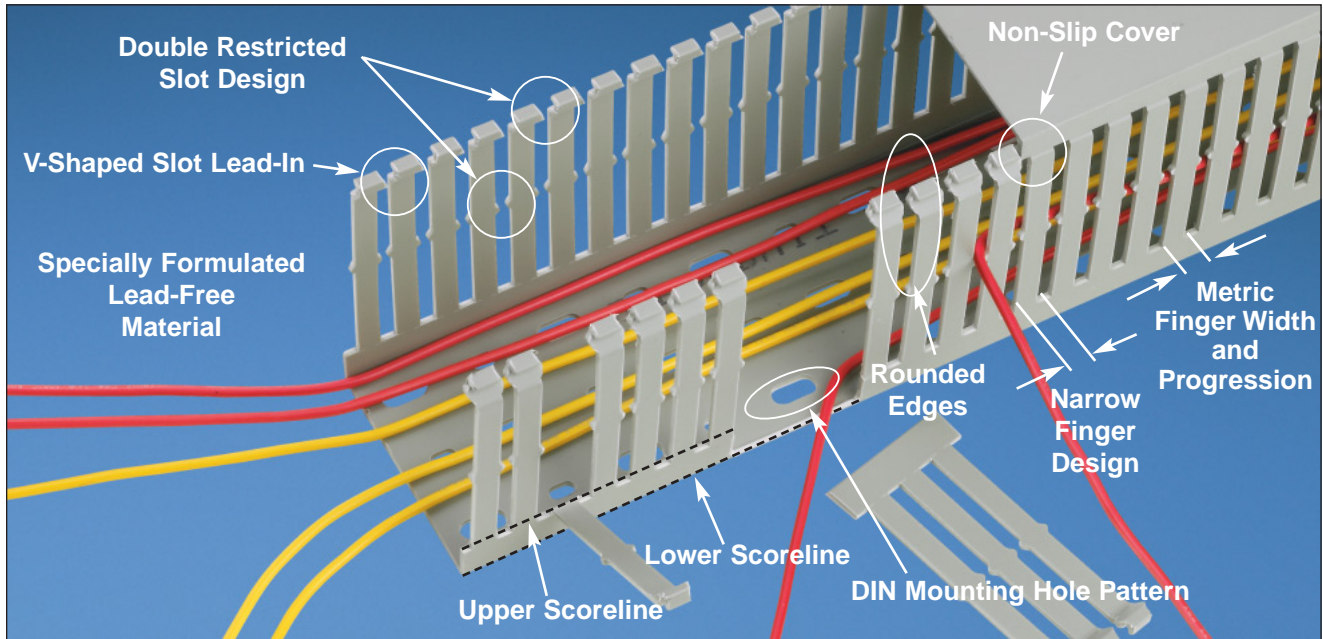

Features	Advantages	Benefits
Metric size and finger progression	Slot width and pitch may match more closely to components with metric dimensions	Provides a metric sized wiring duct solution for applications that specify metric dimensioning, such as when exporting equipment to European countries
Narrow finger and slot design	Provides closer spacing for use with high-density applications	Allows further fanning of wires for neater wire management in high-density control panels
DIN 43 659 mounting hole pattern	Provides the required mounting hole pattern for use in cabinets which are designed to these standards	Meets European standards for use in cabinet applications
Smooth rounded edges	Exclusive <i>PANDUIT</i> ® process rounds the edges in duct slots and at top of duct fingers	Protects hands and wiring/cabling from abrasion
Double scoreline	Upper scoreline at base of finger allows fingers to be broken out without tools  Lower scoreline at base of duct allows sidewall sections to be removed	Allows quick modification for larger cabling bundles saving installation time leading to a lower installed cost  Easier to create tee and corner junctions with full wire carrying capacity
Specially formulated material	Lead-free  Provides a smooth burr-free edge when sidewalls or fingers are broken out	Eliminates health concerns associated with PVC that contains lead  Eliminates the need to deburr saving installation time
Non-slip cover (co-extruded non-slip liner inside duct covers)	Will not slide easily when installed on duct base	Cover stays in place during shipment, vibration and when in a vertical orientation, eliminating rework
Flush cover design	Greater capacity than traditional duct designs  Cover sits flush with sidewall	Can potentially use a smaller size wiring duct for same number of wires  Provides a neat and finished appearance
Double restricted slot design	Once inserted wires are retained in the slot with or without the cover being installed  Second restriction retains cabling within top or bottom portion of slot in larger wiring duct sizes	Eliminates hassle and saves time during installation and maintenance  Provides a neat and finished appearance

Overview

Control Panel

Special Environment

Voice & Data

Tools & Accessories

Technical Info

Index

# Wiring Duct *Control Panel*

## **NEW!** PANDUCT® Type H — Hinged Cover Wiring Duct

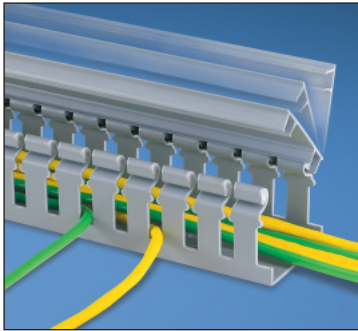

- Made of rigid PVC
- UL Recognized continuous use temperature: 50°C (122°F)
- UL94 Flammability Rating of V-0
- Provided with mounting holes

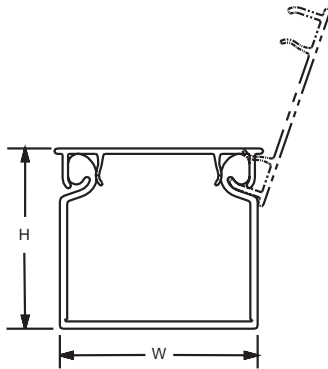

Part Number	Duct Size WxH		Cover Part Number	Duct Std. Ctn. Qty.	Cover Std. Ctn. Qty.	Length (ft)
	In.	mm				
H1.5X2LG6	1.75 x 1.98	44.5 x 50.3	HC1.5LG6	120	120	6
H1.5X3LG6	1.75 x 3.06	44.5 x 77.7	HC1.5LG6	120	120	6
H2X2LG6	2.17 x 1.98	55.1 x 50.3	HC2LG6	120	120	6
H2X3LG6	2.17 x 3.06	55.1 x 77.7	HC2LG6	60	120	6
H2X4LG6	2.17 X 4.10	55.1 X 104.1	HC2LG6	60	120	6
H3X3LG6	3.25 x 3.06	82.6 x 77.7	HC3LG6	60	120	6
H3X4LG6	3.25 x 4.10	82.6 x 104.1	HC3LG6	60	120	6
H4X4LG6	4.25 x 4.10	108.0 x 104.1	HC4LG6	60	60	6

Available in BL (Black), LG (Light Gray) and WH (White).

Reference	Page(s)
Color Availability	F14
Adhesive Tape	E12
Dimensions	F7
Wirefill Guide	F9
Material Specifications	F13
Tools & Accessories	D11, D12, Section E
Installation Tips	F15



## Wiring Duct for Special Environments

Overview

PANDUIT® offers a selection of special materials in PANDUCT® Wiring Duct for routing and concealing wiring in special use environments. Special use environments include applications such as transportation, oil and gas platforms, nuclear power plants and semiconductor and electronics manufacturing.

Control Panel

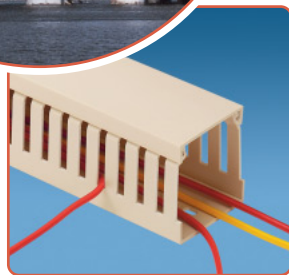
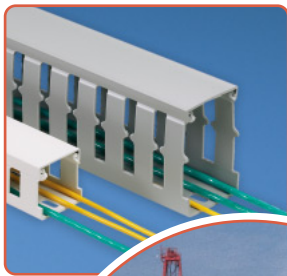

Special Environment

Some of the features and benefits found in PANDUCT® Wiring Duct types for special environments include:

- Specialty materials will not release toxic or corrosive gases that could endanger public safety or damage sensitive electronics, and exhibits excellent flame retardance
- Flush cover design to maximize capacity over the channel footprint and provide a neater appearance
- Integrated non-skid liner insures the duct cover will not slide once installed or during vibration
- Smooth corners and edges will not abrade cabling or irritate hands
- UL Recognized as meeting the requirements of UL Standard 1565 for Positioning Devices
- CE compliant for panels that are to be exported to Europe

Voice & Data

Tools & Accessories

Technical Info

Index



# Wiring Duct for Special Environments

Overview

Control Panel

## Type NNC Halogen Free Metric Wiring Duct

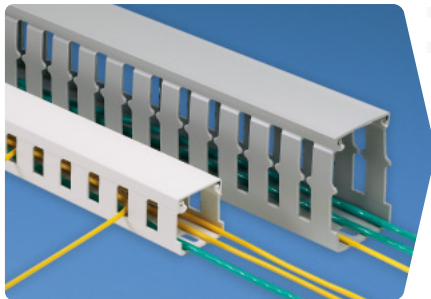

**NEW!**

- Halogen free material is nontoxic, lead-free, environmentally safe and will not release toxic or corrosive gases that could endanger public safety or damage sensitive electronic equipment
- UL94V-0

## Type NE *NORYL*\* Halogen Free Wiring Duct

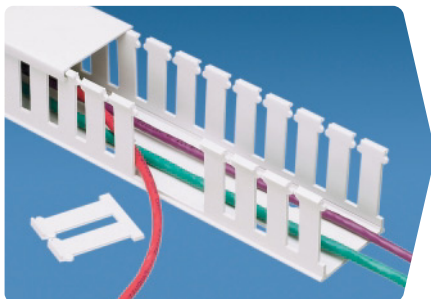

- Halogen free material is nontoxic, lead-free, environmentally safe and will not release toxic or corrosive gases that could endanger public safety or damage sensitive electronic equipment
- UL94V-1

## Type TMC Low Smoke/Low Toxicity Wiring Duct

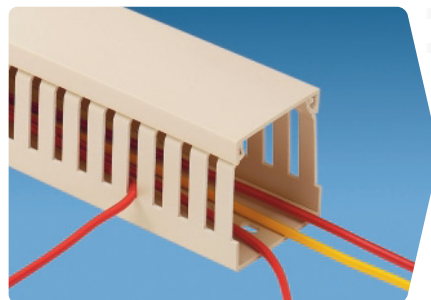

**NEW!**

- Low smoke/Low toxicity material emits a low level of toxic fumes and low smoke emissions when burned
- Meets Federal Rail Administration Guidelines and NFPA 130 requirements for all transit vehicles
- UL94V-0

Special Environment

Data & Voice

Tools & Accessories

Technical Info

Index



**LOW FLAMMABILITY**  
UL94V-0

The material is self-extinguishing and has excellent flame retardancy UL94V-0.



**LOW SMOKE**  
ASTM E 662

The material does not release dense smoke when burned per ASTM E662 test method.



**LOW TOXICITY**  
BSS-7239  
ATS 1000.01

The material does not emit a high volume of toxic gases when burned per Boeing and Airbus test methods.

\*NORYL is a registered trademark of General Electric Company.

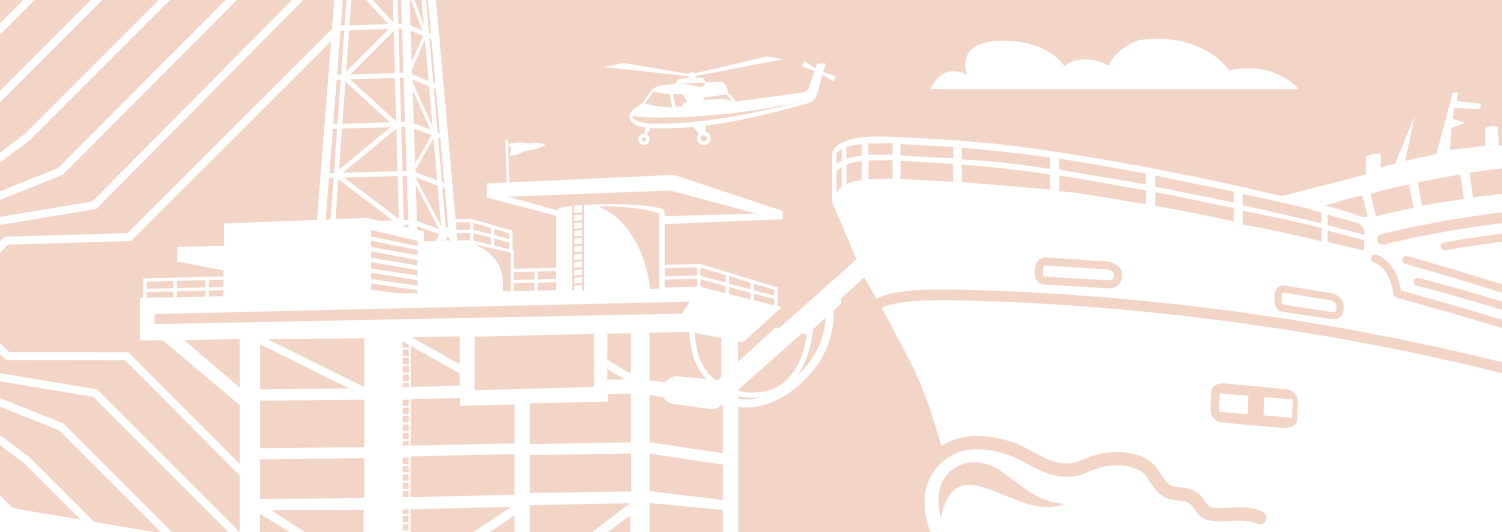

Overview

Control Panel

Special Environment

Data & Voice

Tools & Accessories

Technical Info

Index

**Environment/Material Specifications**

**Typical Applications**

PAGES **C4/C5**



**Semiconductor Manufacturing**  
**Ship Building**  
**Nuclear Power Plants**  
**Oil Platforms**

**Environment/Material Specifications**

**Typical Applications**

PAGES **C6/C7**



**Semiconductor Manufacturing**  
**Ship Building**  
**Nuclear Power Plants**  
**Oil Platforms**

**Environment/Material Specifications**

**Typical Applications**

PAGES **C8/C9**



**Passenger Rail Cars**  
**Other Transportation Vehicles**



The material contains no fluorine, bromide or chlorine and will not emit any corrosive or toxic gases when burned per IEC 60754-2 test method.



Material is rated for a continuous use temperature above 75° C (167° F).

# Wiring Duct *Special Environments*

## **NEW!** PANDUCT® Type NNC — Halogen Free Metric Wiring Duct

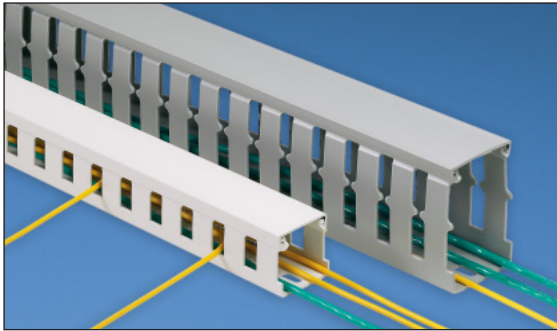

- Made of halogen free material and verified with IEC 60754-2 test method (test on gases evolved during combustion of electric cables)
- UL Recognized continuous use temperature: 95°C (203°F)
- UL94 Flammability Rating of V-0
- Conforms with NFPA 79-2002 section 14.3.1 requirement for flame retardant material
- Provided with DIN 43 659 mounting holes
- Metric sizing and finger progression
- Duct and cover packaged together in 2 meter lengths



- nonmetallic, non-flame propagating CDS
- medium impact resistance
- 211 temperature classification
- cover removal without tools

Part Number	Duct Size WxH		Replacement Cover Part Number	Duct Std. Ctn. Qty.	Cover Std. Ctn. Qty.	Length (M)
	mm	In.				
NNC25X25LG2	24.6 x 23.6	.97 x .93	NC25LG2	20	20	2
NNC25X37LG2	24.6 x 35.8	.97 x 1.41		20	20	
NNC25X50LG2	24.6 x 47.8	.97 x 1.88		20	20	
NNC25X75LG2	24.6 x 72.4	.97 x 2.85		20	20	
NNC37X37LG2	37.1 x 35.8	1.46 x 1.41	NC37LG2	20	20	2
NNC37X50LG2	37.1 x 47.8	1.46 x 1.88		20	20	
NNC37X75LG2	37.1 x 72.4	1.46 x 2.85		20	20	
NNC50X50LG2	49.5 x 47.8	1.95 x 1.88	NC50LG2	20	20	2
NNC50X75LG2	49.5 x 72.4	1.95 x 2.85		10	20	
NNC50X100LG2	49.5 x 97.8	1.95 x 3.85		10	20	
NNC75X75LG2	74.7 x 72.4	2.94 x 2.85	NC75LG2	10	20	2
NNC100X50LG2	99.6 x 47.8	3.92 x 1.88	NC100LG2	10	20	2
NNC100X75LG2	99.6 x 72.4	3.92 x 2.85		10	20	
NNC100X100LG2	99.6 x 97.8	3.92 x 3.85		10	20	

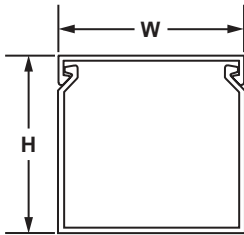

Available in LG (Light Gray) and WH (White).  
Do not allow cutting, tapping or cleaning fluids that contain hydrocarbons to come in contact with Type NNC Wiring Duct as it will cause stress cracking. See [page F15](#) for a list of chemicals to avoid.



LOW FLAMMABILITY  
UL94V-0



HALOGEN FREE  
IEC 60754-2



ELEVATED TEMPERATURE

Reference	Page(s)
Color Availability	<b>F14</b>
Adhesive Tape	<b>E12</b>
Dimensions	<b>F5</b>
Wirefill Guide	<b>F9</b>
Material Specifications	<b>F13</b>
Tools and Accessories	<b>E9, E10, E13, E14</b>
Installation Tips	<b>F15</b>

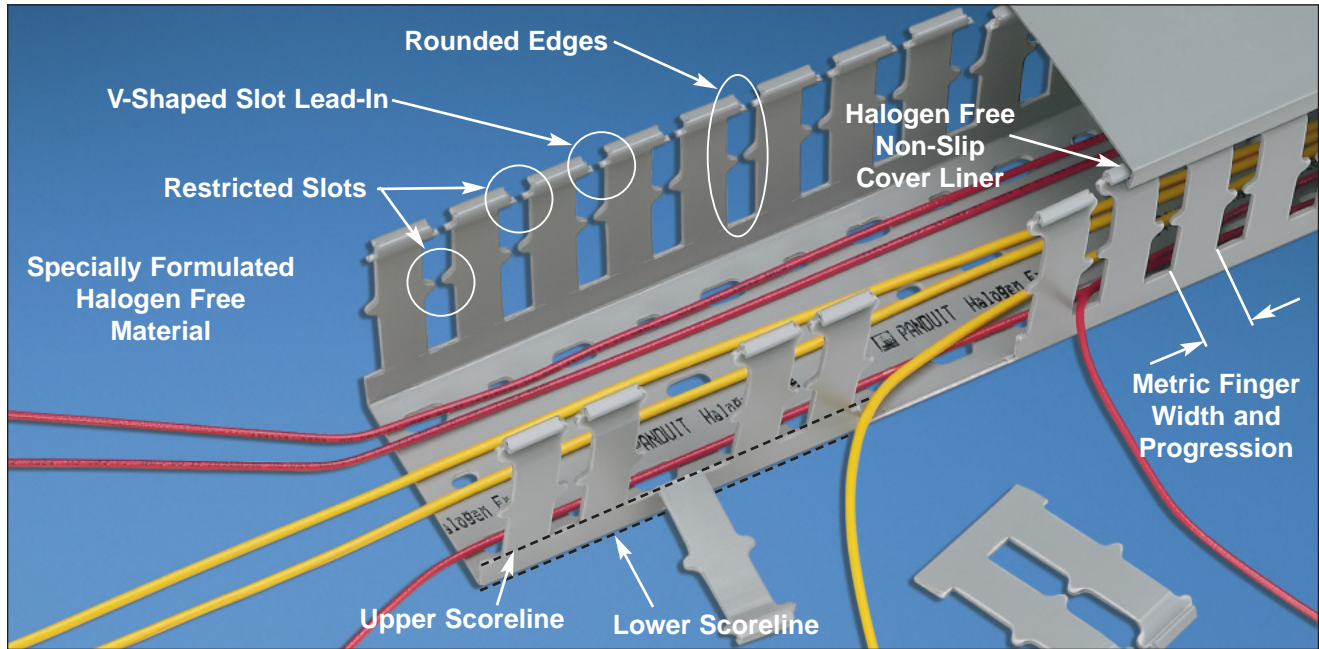

Features	Advantages	Benefits
Halogen free modified PPO material	Material is nontoxic, lead-free, environmentally safe and will not release toxic or corrosive gases that could endanger public safety or damage sensitive electronics  Greater resistance to heat than PVC	Ideal for application where public safety during a fire is a concern  Material is recyclable and suitable for applications requiring eco-friendly materials  Suitable for panel applications where high temperatures exist
UL94V-0 material flame rating	The V-0 flammability rating exceeds the rating of most other halogen free duct materials	Material is self-extinguishing and exhibits the highest flame retardance meeting more electrical panel applications
Halogen free non-slip cover liner	Cover will not slide easily when installed on duct base  Co-extruded liner made from halogen free material	Cover stays in place during shipment, vibration and when in a vertical orientation, eliminating rework  Liner will not emit corrosive or toxic gases
DIN 43 659 mounting hole pattern	Provides the required mounting hole pattern for use in cabinets which are designed to these standards	Meets European standards for use in cabinet applications
Smooth rounded edges	Exclusive <i>PANDUIT</i> ® process rounds the edges in duct slots and at top of duct fingers	Protects hands and wiring/cablings from abrasion
Double scoreline	Upper scoreline at base of finger allows fingers to be broken out without tools  Lower scoreline at base of duct allows sidewall sections to be removed	Allows quick modification for larger cabling bundles saving installation time leading to a lower installed cost  Easier to create tee and corner junctions with full wire carrying capacity
V-shaped slot lead-in	V-shape funnels wires into slot for easier insertion	Speeds wire installation
Double restricted slot design	Once inserted wires are retained in the slot with or without the cover being installed  Second restriction retains cabling within top or bottom portion of slot in larger wiring duct sizes	Eliminates hassle and saves time during installation and maintenance  Provides a neat and finished appearance
Duct and cover packaged together	Fewer part numbers to stock and manage	Reduced inventory cost
Metric size and finger progression	Slot width and pitch may match more closely to components with metric dimensions	Provides a metric sized wiring duct solution for applications that specify metric dimensioning, such as when exporting equipment to European countries

Overview

Control Panel

Special Environment

Voice & Data

Tools & Accessories

Technical Info

Index

# Wiring Duct *Special Environments*

## PANDUCT® Type NE — NORYL\* Halogen Free Wiring Duct

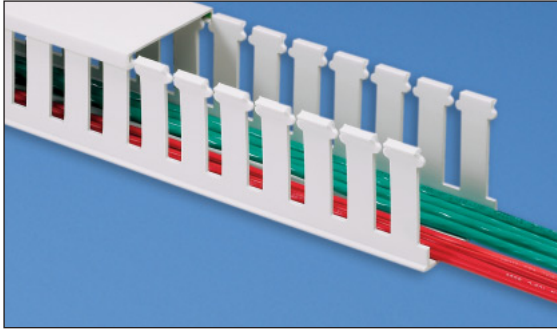

- Made of halogen free NORYL\* material
- UL94 Flammability Rating of V-1
- Provided with mounting holes



- nonmetallic, non-flame propagating CDS
- medium impact resistance
- 211 temperature classification
- cover removal without tools

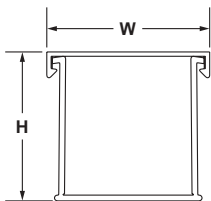

Part Number	Duct Size W x H		Cover Part Number	Duct Std. Ctn. Qty.	Cover Std. Ctn. Qty.	Length (ft)
	In.	mm				
NE.5X.5WH6	.63 x .56	16.0 x 14.2	NC.5WH6	120	120	6
NE.5X1WH6	.63 x 1.06	16.0 x 26.9		120		
NE1X1WH6	1.14 x 1.06	29.0 x 26.9	NC1WH6	120	120	6
NE1X1.5WH6	1.14 x 1.62	29.0 x 41.1		120		
NE1X2WH6	1.14 x 2.06	29.0 x 52.3		120		
NE1X3WH6	1.14 x 3.06	29.0 x 77.7		120		
NE1X4WH6	1.14 x 4.06	29.0 x 103.1	60			
NE1.5X1.5WH6	1.64 x 1.62	41.7 x 41.1	NC1.5WH6	120	120	6
NE1.5X2WH6	1.64 x 2.06	41.7 x 52.3		120		
NE1.5X3WH6	1.64 x 3.06	41.7 x 77.7		120		
NE1.5X4WH6	1.64 x 4.06	41.7 x 103.1		60		
NE2X1WH6	2.14 x 1.06	54.4 x 26.9	NC2WH6	120	120	6
NE2X2WH6	2.14 x 2.06	54.4 x 52.3		120		
NE2X3WH6	2.14 x 3.06	54.4 x 77.7		60		
NE2X4WH6	2.14 x 4.06	54.4 x 103.1		60		
NE2.5X3WH6	2.64 x 3.06	67.1 x 77.7	NC2.5WH6	120	120	6
NE3X1WH6	3.14 x 1.06	79.8 x 26.9	NC3WH6	120	120	6
NE3X2WH6	3.14 x 2.06	79.8 x 52.3		120		
NE3X3WH6	3.14 x 3.06	79.8 x 77.7		60		
NE3X4WH6	3.14 x 4.06	79.8 x 103.1		60		
NE3X5WH6	3.14 x 5.06	79.8 x 128.5		60		
NE4X2WH6	4.14 x 2.06	105.2 x 52.3	NC4WH6	60	120	6
NE4X3WH6	4.14 x 3.06	105.2 x 77.7		60		
NE4X4WH6	4.14 x 4.06	105.2 x 103.1		60		
NE4X5WH6	4.14 x 5.06	105.2 x 128.5		60		

Reference	Page(s)
Color Availability	F14
Adhesive Tape	E12, E13
Dimensions	F6
Wirefill Guide	F10
Material Specifications	F13
Tools and Accessories	Section E
Installation Tips	F15

Available in WH (White) only.

Do not allow cutting, tapping or cleaning fluids that contain hydrocarbons to come in contact with Type NE Wiring Duct as it will cause stress cracking. See page F15 for a list of chemicals to avoid.

\*NORYL is a registered trademark of General Electric Company.

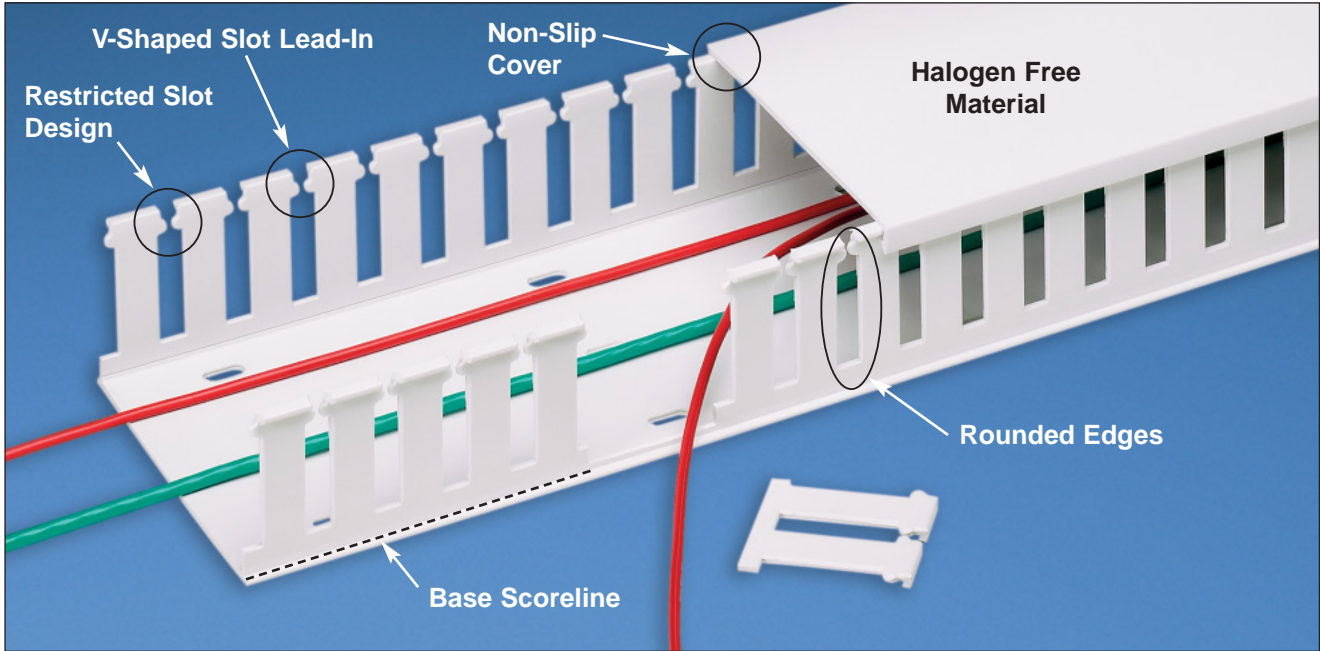

Features	Advantages	Benefits
Halogen free <i>NORYL</i> * material	Material is nontoxic, lead-free, environmentally safe and will not release toxic or corrosive gases that could endanger public safety or damage sensitive electronics  Greater resistance to heat than PVC	Ideal for applications where public safety during a fire is a concern  Material is recyclable and suitable for applications requiring eco-friendly materials  Suitable for panel applications where high temperatures exist
Smooth rounded edges	Exclusive <i>PANDUIT</i> ® process rounds the edges in duct slots and at top of duct fingers	Protects hands and wiring/cabling from abrasion
Non-slip cover (co-extruded non-slip liner inside duct covers)	Will not slide easily when installed on duct base	Cover stays in place during shipment, vibration and when in a vertical orientation, eliminating rework
Base scoreline	Scoreline at base of duct allows sidewall sections to be removed	Easier to create tee and corner junctions with full wire carrying capacity
V-shaped slot lead-in	V-shape funnels wires into slot for easier insertion	Speeds wire installation
Restricted slot design	Once inserted wires are retained in the slot with or without the cover being installed	Eliminates hassle and saves time during installation and maintenance

\*NORYL is a registered trademark of General Electric Company.

# Wiring Duct *Special Environments*

## **NEW!** PANDUCT® Type TMC — Low Smoke/Low Toxicity Wiring Duct

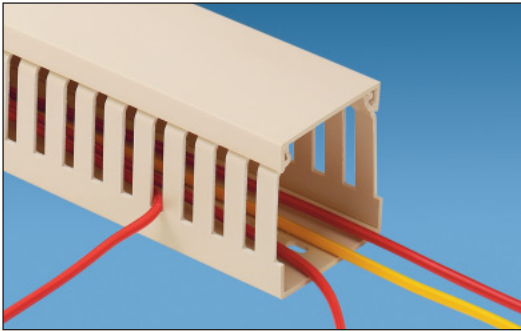

- Made of low smoke, low toxicity and low flammability material
- UL Recognized continuous use temperature: 80°C (176°F)
- UL94 Flammability Rating of V-0
- Conforms with NFPA 79-2002 section 14.3.1 requirement for flame retardant material
- Provided with DIN 43 659 mounting holes
- Metric sizing and finger progression
- Duct and cover packaged together in 2 meter lengths



- nonmetallic, non-flame propagating CDS
- medium impact resistance
- 331 temperature classification
- cover removal without tools

Part Number	Duct Size W x H		Replacement Cover Part Number	Duct Std. Ctn. Qty.	Cover Std. Ctn. Qty.	Length (M)
	mm	In.				
TMC25X37BR2	24.6 x 35.8	.97 x 1.41	TC25BR2	20	20	2
TMC37X37BR2	37.1 x 35.8	1.46 x 1.41	TC37BR2	20	20	2
TMC50X50BR2	49.5 x 48.0	1.95 x 1.89	TC50BR2	20	20	2
TMC75X50BR2	74.7 x 48.0	2.94 x 1.89	TC75BR2	20	20	2
TMC75X75BR2	74.7 x 73.2	2.94 x 2.88		10		
TMC100X50BR2	99.6 x 48.0	3.92 x 1.89	TC100BR2	10	20	2
TMC100X75BR2	99.6 x 73.2	3.92 x 2.88		10		

Available in BR (Natural Beige) only.

Reference	Page(s)
Color Availability	F14
Adhesive Tape	E12
Dimensions	F4
Wirefill Guide	F9
Material Specifications	F13
Tools and Accessories	Section E
Installation Tips	F15

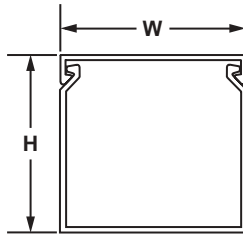

## **NEW!** PANDUCT® Type TMC — Low Smoke / Low Toxicity Solid Divider Wall

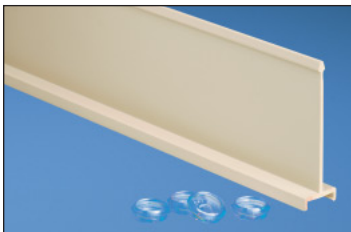

- TMC Divider Wall can be mounted inside TMC Wiring Duct to create multiple channels
- Low smoke, low toxicity and low flammability material
- Simply install the divider wall base when mounting the duct and snap the divider wall onto mounting base (part No. DB-C)

Part Number	For Nominal Duct Height (mm)	Std. Pkg. Qty.	Std. Ctn. Qty.	Length (M)
TMC50DW2	50	2	20	2
TMC75DW2	75	2	20	2

NOTE: Must be used with Mounting Base (DB-C) which is sold separately. Install mounting bases to the duct channel, locate within 2" of each divider wall end and at least every 12" along the length.



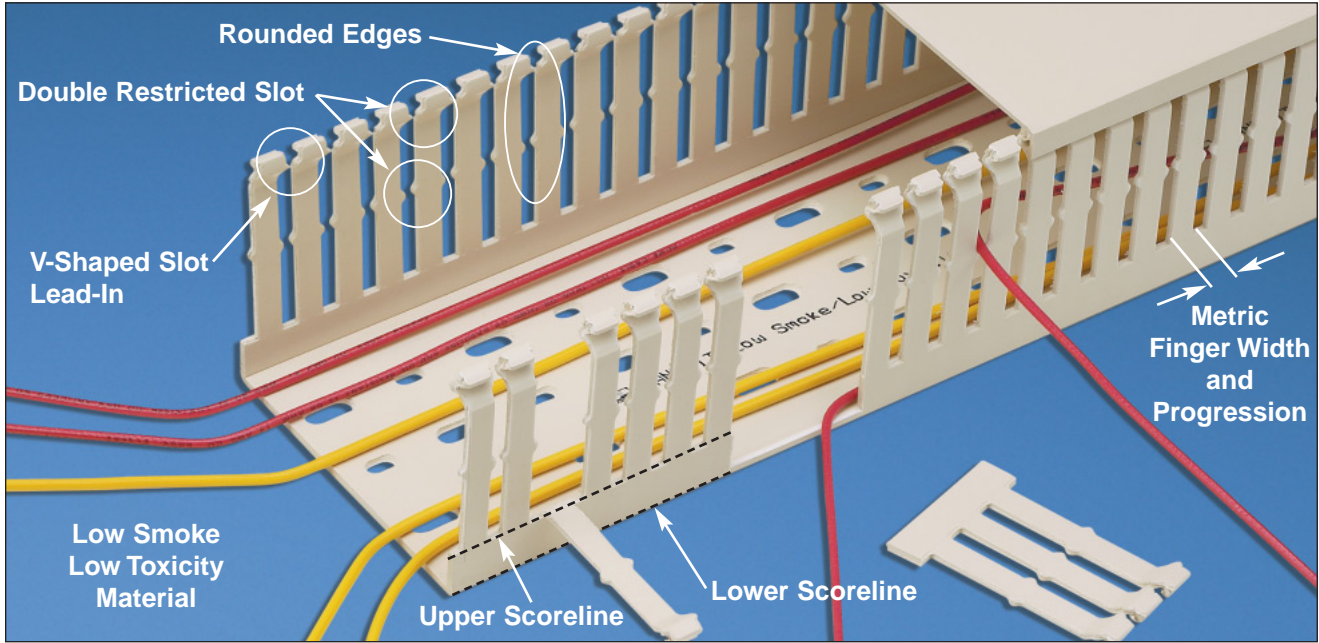

Features	Advantages	Benefits
Low smoke emission material	<p>Low smoke emissions material per ASTM E 662 test method</p> <p>Low smoke emissions result in improved visibility during a fire</p>	<p>Meets the Federal Rail Administration Guidelines and National Fire Protection Agency NFPA 130 standards for Mass Transit OEM applications</p> <p>Passenger safety in the case of a fire</p>
Low toxicity material	<p>Material emits a low level of toxic fumes when burned per Boeing BSS 7239 and Airbus ATS 1000.01 test methods</p> <p>Emits low levels of toxic fumes when burned</p>	<p>Meets the low toxicity requirements of many Mass Transit OEM applications</p> <p>Passenger safety in the case of a fire</p>
Low flammability material	<p>Zero flame spread per ASTM E 162 test method</p> <p>Material maintains a UL94V-0 flammability rating</p> <p>Excellent fire resistance</p>	<p>Meets the Federal Rail Administration Guidelines and National Fire Protection Agency NFPA 130 standards for Mass Transit OEM applications</p> <p>Material is self-extinguishing and exhibits excellent flame retardance</p> <p>Passenger safety in the case of a fire</p>
Lightweight nonmetallic material	<p>Material is 40% lighter than aluminum</p> <p>Easier to handle than metal channel and can be field cut and installed</p> <p>Cuts leave smooth, burr-free edges</p> <p>Nonconductive</p>	<p>Contributes to a reduction in vehicle weight lending to energy savings</p> <p>Reduces installer fatigue and simplifies installation steps leading to a lower installed cost</p> <p>Eliminates need to deburr cut edges simplifying installation and reducing concern of wire abrasion</p> <p>Grounding and bonding of the channel is not required simplifying installation</p>
Non-slip cover (co-extruded non-slip liner inside duct covers)	<p>Will not slide easily when installed on duct base</p>	<p>Cover stays in place during shipment, vibration and when in a vertical orientation, eliminating rework</p>
Smooth rounded edges	<p>Exclusive <i>PANDUIT</i>® process rounds the edges in duct slots and at top of duct fingers</p>	<p>Protects hands and wiring/cablings from abrasion</p>
Double scoreline	<p>Upper scoreline at base of finger allows fingers to be broken out without tools</p> <p>Lower scoreline at base of duct allows sidewall sections to be removed</p>	<p>Allows quick modification for larger cabling bundles saving installation time leading to a lower installed cost</p> <p>Easier to create tee and corner junctions with full wire carrying capacity</p>

Overview

Control Panel

Special Environment

Voice & Data

Tools & Accessories

Technical Info

Index

Overview

# Wiring Duct *Special Environments*

## **Notes**

Control  
Panel

Special  
Environment

Data &  
Voice

Tools &  
Accessories

Technical  
Info

Index

## Wiring Duct for Voice & Data Applications

PANDUIT® offers PANDUCT® Wiring Duct styles specially suited for routing and concealing cabling in communications applications. Applications include wire management for backboard mounted voice, data and video applications, cord management near workstations, use inside communications cabinets and other general purpose applications.

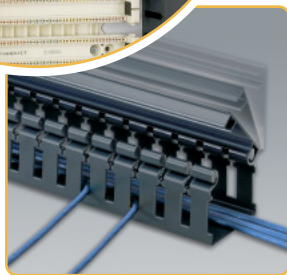
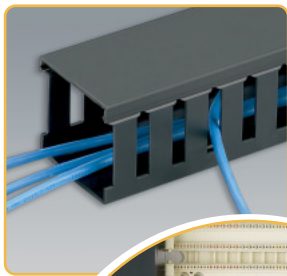

Some of the features and benefits found in PANDUCT® Wiring Duct types for communications applications include:

- Black color to compliment the look of telecommunications racks and hardware
- PANDUIT® exclusive wide slot/wide finger progression and hinging cover provides easy access ideal for frequent moves, adds and changes
- Solid wall raceway completely conceals cabling in applications where frequent breakouts are not required
- Bend radius control accessories for cabling as required in NFPA 79-2002 section 14.1.4.9 and TIA/EIA 568-B and 569-A
- Smooth corners and edges that will not abrade cabling or irritate hands
- UL94 flammability rating of V-0 for excellent flame retardancy



# Wiring Duct for Backboard Applications

Overview

Control Panel

Special Environment

Voice & Data

Tools & Accessories

Technical Info

Index

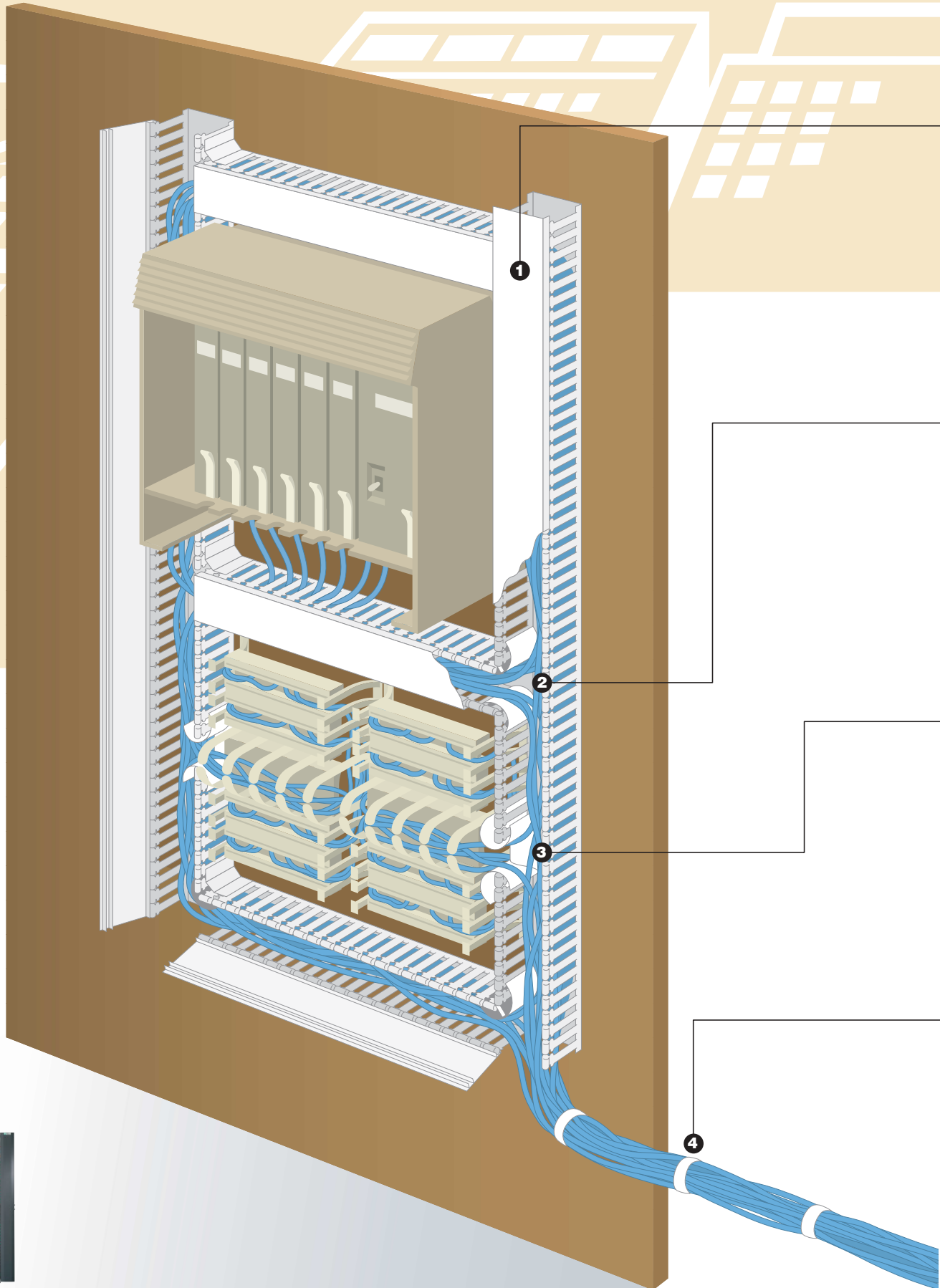

For Cable Management Solutions for Network Racks see [page D14](#).

**1 Type H Hinged Cover Wiring Duct**

PAGE **D6/D7**

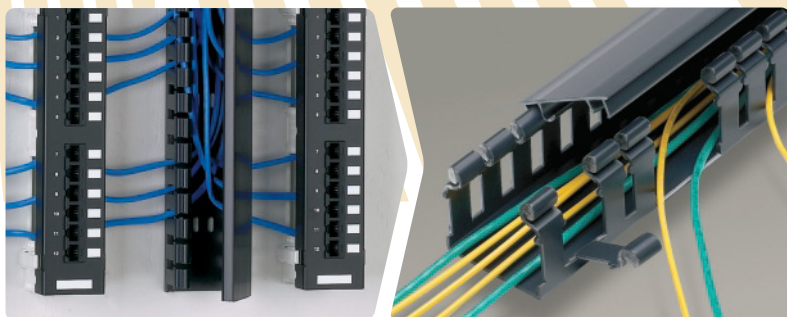

**NEW!**

Features wide slot/wide finger progression for communications cabling. Provides easy access to cabling for moves, adds and changes.

Control Panel

**2 Bend Radius Control Corner Strips**

PAGE **D11**



Snap to duct walls at tee intersections and right angles to provide cable protection around corners.

Special Environment

Voice & Data

**3 Bend Radius Control Trumpet**

PAGE **D11**

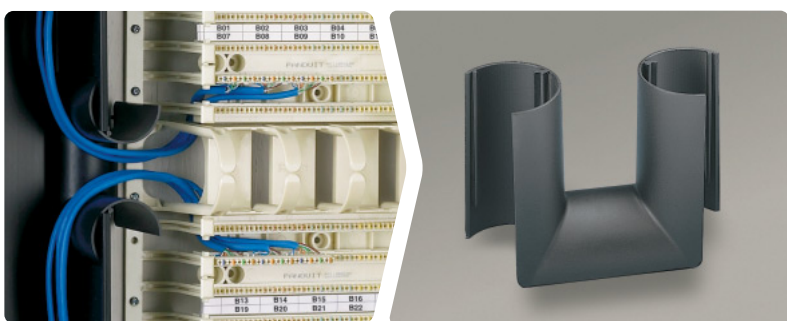

Provides a smooth transition from hardware to duct channel.

Tools & Accessories

**4 TAK-TAPE™ Hook & Loop Strips**

PAGE **D13**



Secure cable bundles entering or exiting the wiring duct. Tape roll allows any size cable bundle to be easily secured.

Technical Info

Index

# Cord Management at the Workstation

Overview

Control Panel

Special Environment

Voice & Data

Tools & Accessories

Technical Info

Index

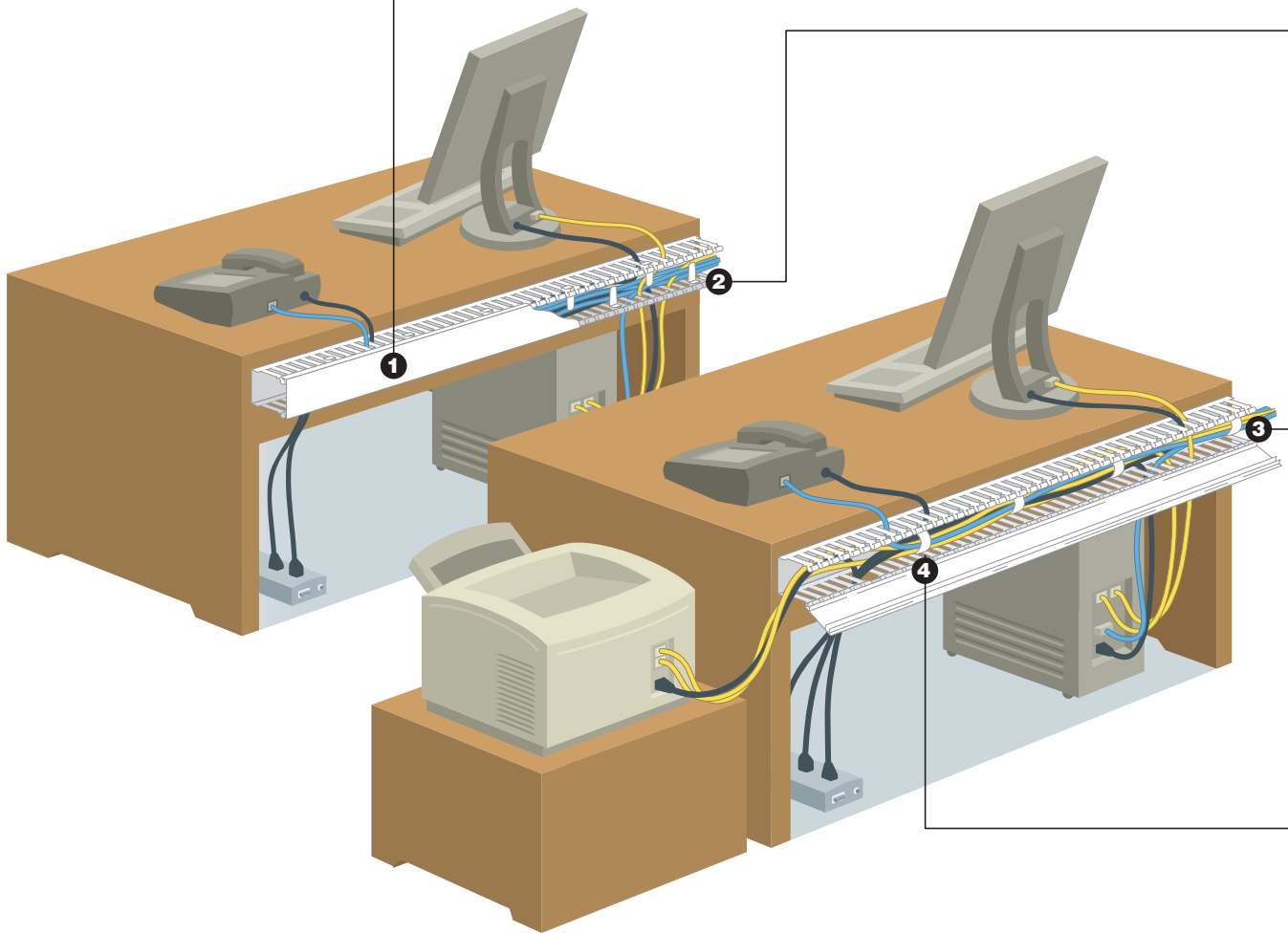

For information on the complete line of PANDUCT® Wiring Duct see [page B1](#)

**1 Type H Hinged Cover Wiring Duct**

PAGE **D6/D7**

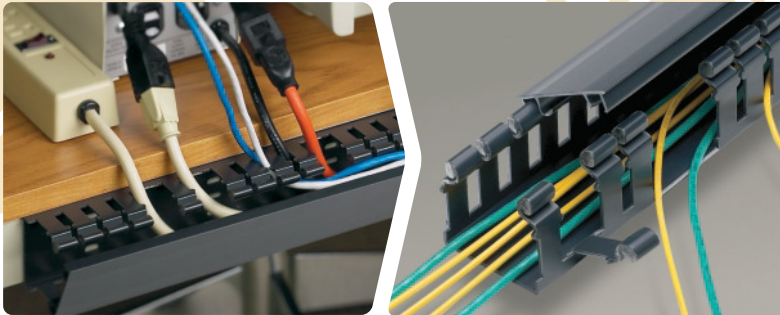

**NEW!**

Contain cable slack at the workstation. Hinged cover provides easy access to cabling for moves, adds and changes.

Control Panel

**2 Wire Retainers**

PAGE **D12**

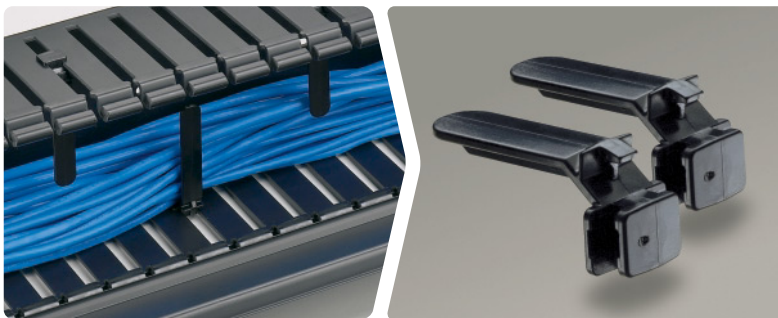

Contain cabling when duct cover is opened. Wire retainers snap easily between duct fingers.

Special Environment

**3 ULTRA-CINCH™ Hook & Loop Ties TAK-TY® Hook & Loop Cable Ties**

PAGE **D12**

**NEW!**



Very easy to release and reuse, making them ideal for applications where changes are anticipated or continuous access is required.

Tools & Accessories

**4 TAK-TY® Hook & Loop Cable Tie Mounts**

PAGE **D13**



Route and secure sensitive communication cabling without damaging the cable bundles. Optional adhesive backed mounts can be easily mounted within the wiring duct base.

Technical Info

Index

# Wiring Duct *Voice & Data*

## **NEW!** PANDUCT® Type H — Hinged Cover Wiring Duct

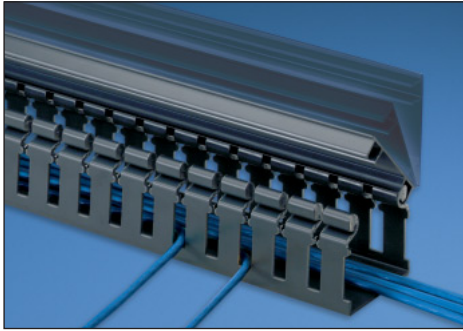

- Made of rigid PVC
- UL Recognized continuous use temperature: 50°C (122°F)
- UL94 Flammability Rating of V-0
- Provided with mounting holes

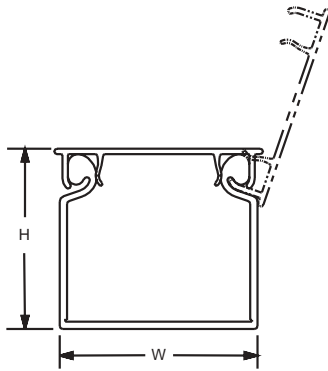

Part Number	Duct Size WxH		Cover Part Number	Duct Std. Ctn. Qty.	Cover Std. Ctn. Qty.	Length (ft)
	In.	mm				
H1.5X2BL6	1.75 x 1.98	44.5 x 50.3	HC1.5BL6	120	120	6
H1.5X3BL6	1.75 x 3.06	44.5 x 77.7	HC1.5BL6	120	120	6
H2X2BL6	2.17 x 1.98	55.1 x 50.3	HC2BL6	120	120	6
H2X3BL6	2.17 x 3.06	55.1 x 77.7	HC2BL6	60	120	6
H2X4BL6	2.17 x 4.10	55.1 x 104.1	HC2BL6	60	120	6
H3X3BL6	3.25 x 3.06	82.6 x 77.7	HC3BL6	60	120	6
H3X4BL6	3.25 x 4.10	82.6 x 104.1	HC3BL6	60	120	6
H4X4BL6	4.25 x 4.10	108.0 x 104.1	HC4BL6	60	60	6

Available in BL (Black), LG (Light Gray) and WH (White).

Reference	Page(s)
Color Availability	<b>F14</b>
Adhesive Tape	<b>E12</b>
Dimensions	<b>F7</b>
Wirefill Guide	<b>F9</b>
Material	
Specifications	<b>F13</b>
Tools & Accessories	<b>D11, D12, Section E</b>
Installation Tips	<b>F15</b>



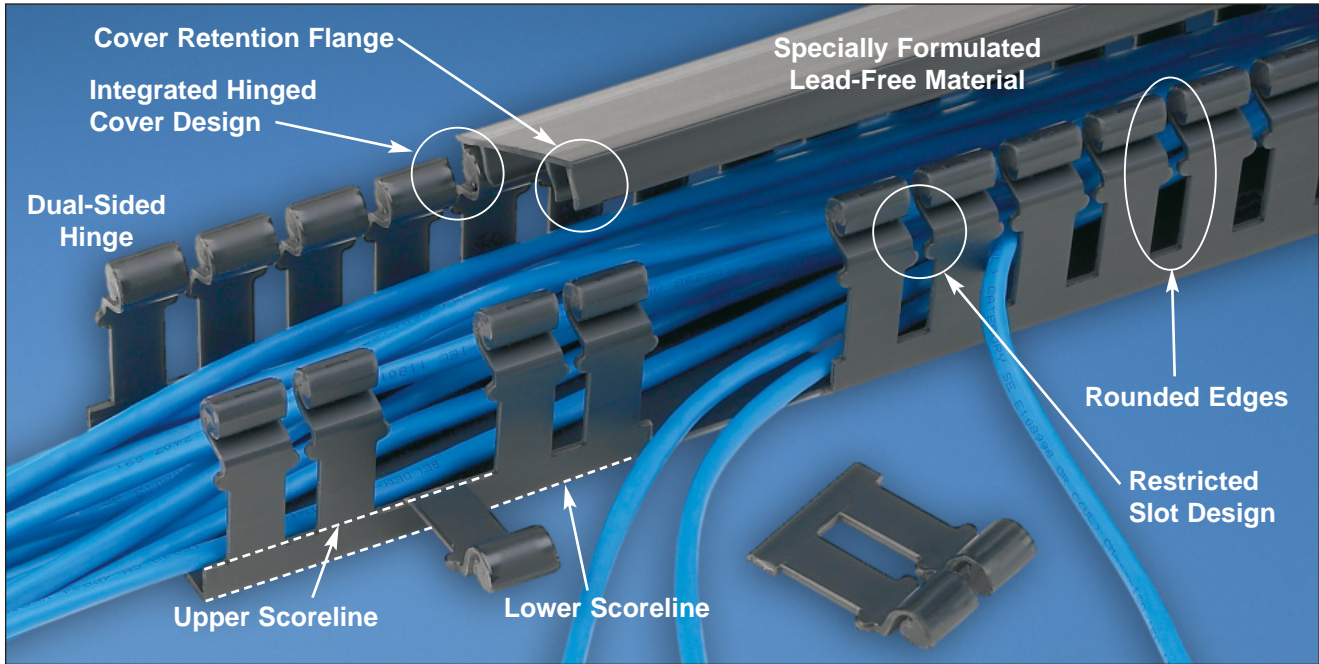

Features	Advantages	Benefits
Integrated hinged cover design	<i>PANDUIT</i> ® exclusive design provides access to duct channel without the need to completely remove and reinstall the cover	Covers are less likely to be misplaced maintaining a neater appearance to the installation
Dual-sided hinge	Cover can hinge open up to 100° from either sidewall of duct base	Provides full access to the channel without the need to remove the cover
Cover retention flange	Enables easier cover engagement with the base  Engages cover securely with base  Allows cover to open and stay in position at any angle	Provides easy snap-on installation  Cover stays in place during vibration and when in a vertical orientation, eliminating rework  Cover will function and stay open regardless of vertical or horizontal position duct is mounted in
Cover removal rib	Provides surface to grip cover	Cover is easy to open or remove
Smooth rounded edges	Exclusive <i>PANDUIT</i> ® process rounds the edges in duct slots and at top of duct fingers	Protects hands and wiring/cabling from abrasion
Double scoreline	Upper scoreline at base of finger allows fingers to be broken out without tools  Lower scoreline at base of duct allows sidewall sections to be removed	Allows quick modification for larger cabling bundles saving installation time leading to a lower installed cost  Easier to create tee and corner junctions with full wire carrying capacity
Restricted slot design	Once inserted wires are retained in the slot with or without the cover being installed	Eliminates hassle and saves time during installation and maintenance
Specially formulated material	Lead-free  Provides a smooth burr-free edge when sidewalls or fingers are broken out	Removes health concerns associated with PVC that contains lead  Eliminates the need to deburr saving installation time

Overview

Control Panel

Special Environment

Voice & Data

Tools & Accessories

Technical Info

Index

# Wiring Duct *Voice & Data*

## PANDUCT® Type FS — Solid Wall Raceway

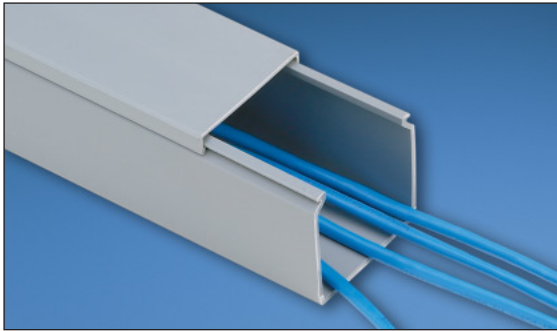

- Solid wall design fully encloses cables providing maximum protection and aesthetics
- Made of rigid PVC
- UL Recognized continuous use temperature: 50°C (122°F)
- UL94 Flammability Rating of V-0
- Supplied without mounting holes



- nonmetallic, non-flame propagating CDS
- medium impact resistance
- 331 temperature classification
- cover removal without tools
- IP40 degree of protection

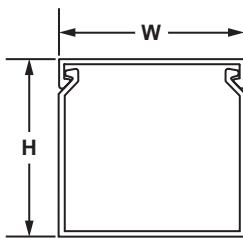

Part Number	Duct Size W x H		Cover Part Number	Duct Std. Ctn. Qty.	Cover Std. Ctn. Qty.	Length (ft)
	In.	mm				
> FS.5X.5LG6NM	.69 x .60	17.5 x 15.2	C.5LG6	120	120	6
> FS.5X1LG6NM	.69 x 1.06	17.5 x 26.9		120		
> FS.75X.75LG6NM	.93 x .82	23.6 x 20.8	C.75LG6	120	120	6
> FS1X1LG6NM	1.26 x 1.12	32.0 x 28.4	C1LG6	120	120	6
> FS1X1.5LG6NM	1.26 x 1.62	32.0 x 41.1		120		
> FS1X2LG6NM	1.26 x 2.12	32.0 x 53.8		120		
> FS1X3LG6NM	1.26 x 3.12	32.0 x 79.2		120		
> FS1X4LG6NM	1.26 x 4.10	32.0 x 104.1		60		
> FS1.5X1LG6NM	1.75 x 1.12	44.5 x 28.4	C1.5LG6	120	120	6
> FS1.5X1.5LG6NM	1.75 x 1.62	44.5 x 41.1		120		
> FS1.5X2LG6NM	1.75 x 2.12	44.5 x 53.8		120		
> FS1.5X3LG6NM	1.75 x 3.12	44.5 x 79.2		120		
> FS2X1LG6NM	2.25 x 1.12	57.2 x 28.4	C2LG6	120	120	6
> FS2X1.5LG6NM	2.25 x 1.62	57.2 x 41.1		120		
> FS2X2LG6NM	2.25 x 2.12	57.2 x 53.8		120		
> FS2X3LG6NM	2.25 x 3.12	57.2 x 79.2		60		
> FS2X4LG6NM	2.25 x 4.10	57.2 x 104.1		60		
> FS3X1LG6NM	3.25 x 1.12	82.6 x 28.4	C3LG6	120	120	6
> FS3X2LG6NM	3.25 x 2.12	82.6 x 53.8		120		
> FS3X3LG6NM	3.25 x 3.12	82.6 x 79.2		60		
> FS3X4LG6NM	3.25 x 4.10	82.6 x 104.1		60		
> FS3X5LG6NM	3.25 x 5.10	82.6 x 129.5		60		
> FS4X2LG6NM	4.25 x 2.12	108.0 x 53.8	C4LG6	60	120	6
> FS4X3LG6NM	4.25 x 3.12	108.0 x 79.2		60		
> FS4X4LG6NM	4.25 x 4.10	108.0 x 104.1		60		
> FS4X5LG6NM	4.25 x 5.10	108.0 x 129.5		60		
> FS6X4LG6NM	6.25 x 4.15	158.8 x 105.4	C6LG6	60	120	6

>SYMBOL indicates parts available with mounting holes. Remove NM from part number. Part Number shown for LG (Light Gray). For other color availability see Color Selection Guide, page F15.

Reference	Page(s)
Color Availability	F14
Adhesive Tape	E12, E13
Dimensions	F3
Wirefill Guide	F8
Material Specifications	F13
Tools & Accessories	D11, D12, Section E
Installation Tips	F15

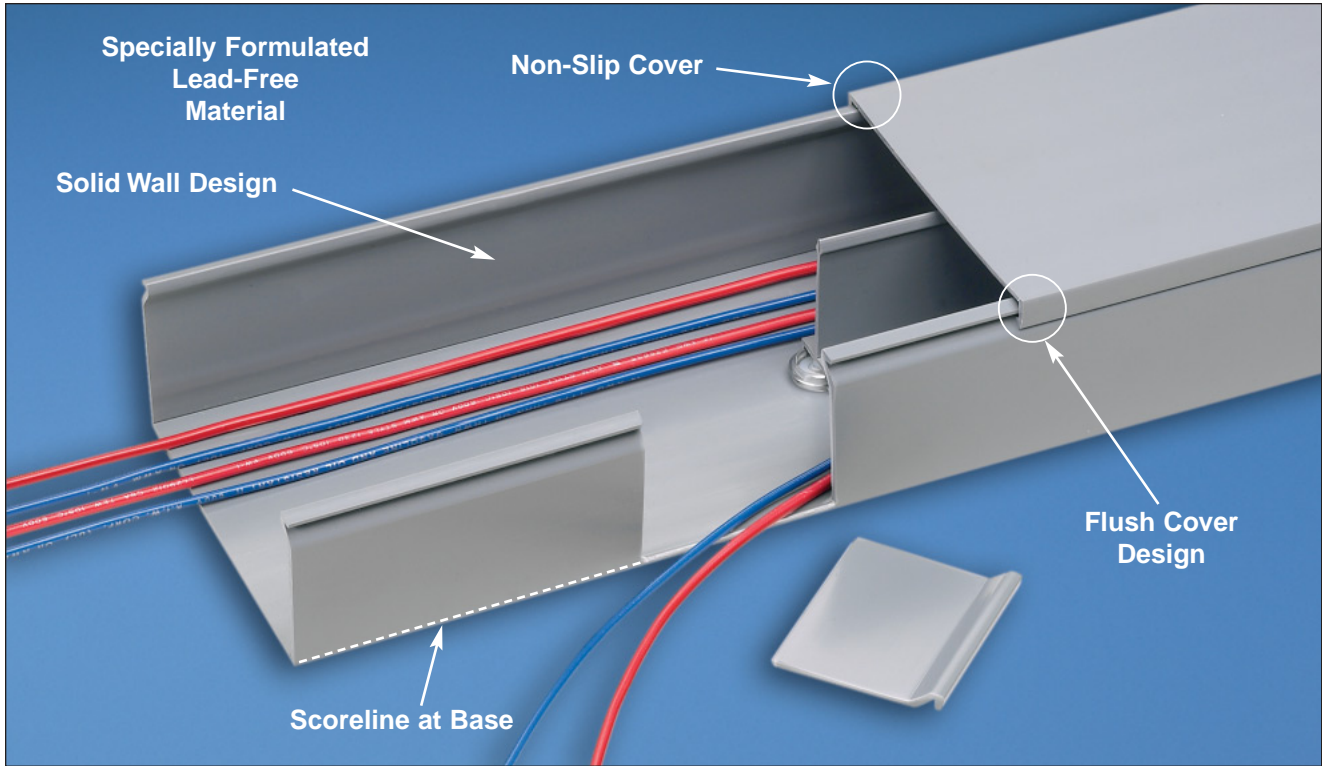

Features	Advantages	Benefits
Solid wall design	Fully encloses the cables providing maximum protection	Provides a more aesthetically pleasing solution for applications that do not require frequent cable breakouts
Flush cover design	Greater capacity than traditional duct designs Cover sits flush with sidewall	Can potentially use a smaller size wiring duct for same number of wires Provides a neat and finished appearance
Base scoreline	Scoreline at base of duct allows sidewall sections to be removed	Easier to create tee and corner junctions with full wire carrying capacity
Non-slip cover (co-extruded non-slip liner inside duct covers)	Will not slide easily when installed on duct base	Cover stays in place during shipment, vibration and when in a vertical orientation, eliminating rework
Specially formulated material	Lead-free Provides a smooth burr-free edge when sidewalls are broken out	Eliminates health concerns associated with PVC that contains lead Eliminates the need to deburr saving installation time

Overview

Control Panel

Special Environment

Voice & Data

Tools & Accessories

Technical Info

Index

# Wiring Duct *Voice & Data*

## PANDUCT® Type G — Wide Slot Wiring Duct

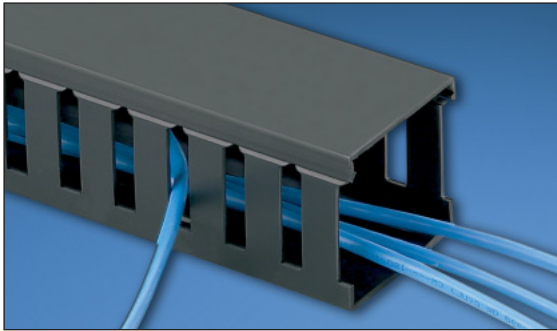

- Wide selection of sizes available in black color to compliment the look of telecommunications racks and hardware
- Made of rigid PVC
- UL Recognized continuous use temperature: 50°C (122°F)
- UL94 Flammability Rating of V-0
- Provided with mounting holes
- Conforms with NFPA 79-2002 section 14.3.1 requirement for flame retardant material



- nonmetallic, non-flame propagating CDS
- medium impact resistance
- 331 temperature classification
- cover removal without tools

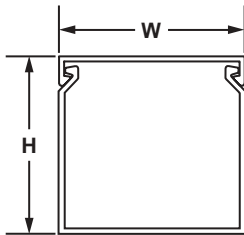

Reference	Page(s)
Color Availability	<b>F14</b>
Adhesive Tape	<b>E12, E13</b>
Dimensions	<b>F2</b>
Wirefill Guide	<b>F8</b>
Material Specifications	<b>F13</b>
Tools & Accessories	<b>D11, D12, Section E</b>
Installation Tips	<b>F15</b>

Part Number	Duct Size W x H		Cover Part Number	Duct Std. Ctn. Qty.	Cover Std. Ctn. Qty.	Length (ft)
	In.	mm				
<b>G.75X2BL6</b>	.93 x 2.03	23.6 x 51.6	<b>C.75BL6</b>	120	120	6
<b>G1X1BL6</b>	1.26 x 1.12	32.0 x 28.4	<b>C1BL6</b>	120	120	6
<b>G1X1.5BL6</b>	1.26 x 1.62	32.0 x 41.1		120		
<b>G1X2BL6</b>	1.26 x 2.12	32.0 x 53.8		120		
<b>G1X3BL6</b>	1.26 x 3.12	32.0 x 79.2		120		
<b>G1X4BL6</b>	1.26 x 4.10	32.0 x 104.1		60		
<b>G1.5X1.5BL6</b>	1.75 x 1.62	44.5 x 41.1	<b>C1.5BL6</b>	120	120	6
<b>G1.5X2BL6</b>	1.75 x 2.12	44.5 x 53.8		120		
<b>G1.5X3BL6</b>	1.75 x 3.12	44.5 x 79.2		120		
<b>G1.5X4BL6</b>	1.75 x 4.10	44.5 x 104.1		60		
<b>G2X1BL6</b>	2.25 x 1.12	57.2 x 28.4	<b>C2BL6</b>	120	120	6
<b>G2X2BL6</b>	2.25 x 2.12	57.2 x 53.8		120		
<b>G2X3BL6</b>	2.25 x 3.12	57.2 x 79.2		60		
<b>G2X4BL6</b>	2.25 x 4.10	57.2 x 104.1		60		
<b>G2.5X3BL6</b>	2.75 x 3.12	69.9 x 79.2	<b>C2.5BL6</b>	120	120	6
<b>G3X2BL6</b>	3.25 x 2.12	82.6 x 53.8	<b>C3BL6</b>	120	120	6
<b>G3X3BL6</b>	3.25 x 3.12	82.6 x 79.2		60		
<b>G3X4BL6</b>	3.25 x 4.10	82.6 x 104.1		60		
<b>G4X2BL6</b>	4.25 x 2.12	108.0 x 53.8	<b>C4BL6</b>	60	120	6
<b>G4X3BL6</b>	4.25 x 3.12	108.0 x 79.2		60		
<b>G4X4BL6</b>	4.25 x 4.10	108.0 x 104.1		60		
<b>G4X5BL6</b>	4.25 x 5.10	108.0 x 129.5		60		

Part Number shown for BL (Black). For other color availability see Color Selection Guide, **page F14**.

## PANDUCT® Duct Corner Strip with 1" Bend Radius Control

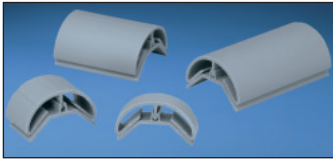
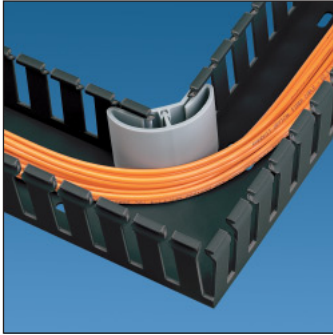

- Creates a strong rigid corner at wiring duct junctions
- Provides bend radius protection for cabling as required in NFPA 79-2002 section 14.1.4.9 and TIA/EIA 568-B and 569-A
- Available in five pre-cut sizes and 6' lengths that can be cut-to-size to meet any size requirement
- Easy to install two-piece design
- Compatible with all styles of PANDUIT® Wiring Duct
- Made of PVC material

Part Number	Part Description	For Duct Height		Color	Std. Pkg. Qty.	Std. Ctn. Qty.
		In.	mm			

### 6 Foot Lengths for use with all Types of PVC Wiring Duct\*

<b>CSC1LG6</b>	Cut-to-size 6 foot corner strip with a 1" bend radius.	All sizes (Cut to duct height)	All sizes (Cut to duct height)	Light Gray	6	120
<b>CSC1WH6</b>				White	6	120
<b>CSC1BL6</b>				Black	6	120

### Pre-Cut Pieces for use with all Types of PVC Wiring Duct^

<b>CSPC1LG-Q</b>	1" bend radius corner strip pre-cut for 1" wall height.	1.00	25.4	Light Gray	25	250
<b>CSPC1.5LG-Q</b>	1" bend radius corner strip pre-cut for 1.5" wall height (2.0" Type H Duct).	1.50	38.1	Light Gray	25	250
<b>CSPC2LG-Q</b>	1" bend radius corner strip pre-cut for 2" wall height.	2.00	50.8	Light Gray	25	250
<b>CSPC3LG-Q</b>	1" bend radius corner strip pre-cut for 3" wall height.	3.00	76.2	Light Gray	25	250
<b>CSPC4LG-Q</b>	1" bend radius corner strip pre-cut for 4" wall height (4.0" Type H Duct).	4.00	101.6	Light Gray	25	250

\*Order number of feet required, in multiples of 6' or Standard Package Quantity.

^Order number of pieces required in multiples of Standard Package Quantity. Pre-cut pieces available in LG (Light Gray) only.

## Bend Radius Control Trumpet

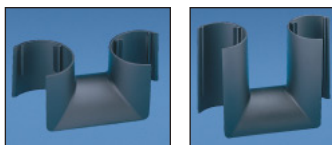
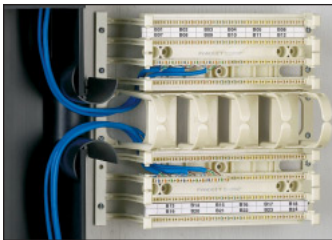

TRC2BL

TRC4BL



TRC2HDBL

- Provides method to transition cabling from wall mounted hardware to wiring duct channel
- Provides bend radius protection for cabling as required in NFPA 79-2002 section 14.1.4.9 and TIA/EIA 568-B and 569-A
- Made of ABS material

Part Number	Part Description	For Duct Height		Std. Pkg. Qty.	Std. Ctn. Qty.
		In.	mm		
<b>TRC2BL</b>	Bend radius control trumpet for exiting at the sidewall of 2" wall heights of Type G or Type FS Wiring Duct channels.	2.00	50.8	1	10
<b>TRC4BL</b>	Bend radius control trumpet for exiting at the sidewall of 4" wall heights of Type G or Type FS Wiring Duct channels.	4.00	101.6	1	10
<b>TRC2HDBL</b>	Bend radius control trumpet for exiting at the sidewall of 2" wall heights of Type H Hinged Cover Wiring Duct channels.	2.00	50.8	1	10

Order number of pieces required in multiples of Standard Package Quantity. Available in BL (Black) only.

Overview

Control Panel

Special Environment

Voice & Data

Tools & Accessories

Technical Info

Index

# Wiring Duct *Voice & Data*

## TAK-TY® Hook & Loop Cable Ties



- Releasable and reusable hundreds of times
- No risk of over-tensioning and damaging high performance cabling
- No installation tool needed
- Operating temperature range: 0 to 220°F
- Several styles (HLS, HLM, HLT, and HLC) available to suit a variety of applications
- Select styles (HLSP and HLTP) are UL Listed for use in air handling space applications per NEC Section 300-22 (C) and (D)



Part Number	Part Description	Max. Bundle Diameter		Min. Loop Tensile Str. (Lbs.)	Length (In.)	Std. Pkg. Qty.	Std. Ctn. Qty.
		In.	mm				

### 15' & 75' Rolls — Can be cut to desired length, eliminating waste

HLS-15R0	15' roll, .75" width, Standard, Black.	Various	Various	50	180.0	1	10
HLS-75R0	75' roll, .75" width, Standard, Black.	Various	Various	50	900.0	1	10

### Loop Ties — Slot allows for pre-wrapping of bundles

HLT3I-X0	Loop tie, 12.0" length, .50" width, Intermediate, Black.	3.18	81	40	12.0	10	100
----------	--	------	----	----	------	----	-----

All styles may be used with ABMT mounts on [page D13](#).  
Minimum 2" overlap required to achieve loop tensile rating.

## **NEW!** ULTRA-CINCH™ Hook & Loop Ties



- Innovative product with hooks and loops on the same side to secure a greater range of bundle diameters, including smaller bundles
- Low profile cinch ring reduces overall bundle size
- Sturdy brass grommet (UGCTC/UGCTE styles) resists pull-out, and allows cable bundles to be securely fastened to surfaces
- PANDUIT® recommends flat-head screws for use in grommet applications



Part Number	Part Description	Max. Bundle Diameter		Min. Loop Tensile Str. (Lbs.)	Length (In.)	Std. Pkg. Qty.	Std. Ctn. Qty.
		In.	mm				
UCT3S-X0	Cinch tie, 12" length, .85" width, Standard, Black.	3.00	76	50	12.0	10	100
UCT5S-X0	Cinch tie, 18" length, .85" width, Standard, Black.	5.00	127	50	18.0	10	100
UGCTE3S-X0	Cinch tie w/end mount grommet, 12" length, .85" width, Standard, Black.	3.00	76	50	12.0	10	100
UGCTC5S-X0	Cinch tie w/center mount grommet, 18" length, .85" width, Standard, Black.	5.00	127	50	18.0	10	100

All styles may be used with ABMT mounts on [page D13](#).  
Minimum 2" overlap required to achieve loop tensile rating.

## TAK-TAPE™ Hook & Loop Strips



- Thin and flexible to quickly wrap around bundle
- Adjustable, releasable and reusable
- Large continuous roll you can cut to size with Telco snips, scissors or PANDUIT® cutter (included with TTS-35RX0 only)
- Wide (3/4") black strap spreads out bundling forces over large area



Part Number	Part Description	Max. Bundle Diameter		Min. Loop Tensile Str. (Lbs.)	Length (ft)	Std. Pkg. Qty.	Std. Ctn. Qty.
		In.	mm				
TTS-20R0	20' roll, .75" width, Standard, Black, Reusable case.	Various	Various	40	20	1	10
TTS-35RX0	35' rolls, .75" width, Standard, Black, 10-Pack (shrink-wrapped).	Various	Various	40	35	1	10

All styles may be used with ABMT mounts shown below  
Minimum 2" overlap required to achieve loop tensile rating

## TAK-TY® Hook & Loop Cable Tie Mounts



- Used with PANDUIT® cable ties for a complete wire routing solution
- Adhesive backing allows routing of wires and cables where mounting holes cannot be drilled
- Tear tab provides fast and easy liner removal to speed installation
- For indoor use

Part Number	Material	Color	Height		Length		Width		Max. Static Load		Mounting Method	Used With Cable Ties	Std. Pkg. Qty.
			In.	mm	In.	mm	In.	mm	g	Lbs.			
ABMT-A-C	Nylon 6.6	Natural	.34	8.4	1.10	28.7	1.10	28.6	174	.38	Rubber Adhesive	TAK-TY® Hook & Loop Cable Ties	100
ABMT-A-C20	Nylon 6.6	Black	.34	8.4	1.10	28.7	1.10	28.6	174	.38	Rubber Adhesive	TAK-TY® Hook & Loop Cable Ties	100
ABMT-S6-C	Nylon 6.6	Natural	.34	8.4	1.10	28.7	1.10	28.6	—	—	#6 (M3) Screw	TAK-TY® Hook & Loop Cable Ties	100
ABMT-S6-C20	Nylon 6.6	Black	.34	8.4	1.10	28.7	1.10	28.6	—	—	#6 (M3) Screw	TAK-TY® Hook & Loop Cable Ties	100

Overview

Control Panel

Special Environment

Voice & Data

Tools & Accessories

Technical Info

Index

# Wiring Duct *Voice & Data*

## Cable Management Solutions for Network Racks

### STANDARD Cable Management Rack System The Standard in Cable Management

*Features horizontal and vertical cable managers that help organize and manage cable routing*

- Slotted duct organizes and manages cables for simple moves, adds and changes
- Cable pass through holes facilitate routing of cable from front to rear
- Patented wire retainers hold cable in place during cable installation and maintenance



### NETFRAME® Cable Management Rack System The Modular Rack Solution

*Designed to support heavy equipment and network cabling in telecommunication rooms*

- UL listed for 1500 lbs. load rating to accommodate large networking equipment
- Deep vertical channel design provides distribution cable pathway
- Multiple vertical cable management options are simple to install and allow user to configure system to their preferences



### PATCHRUNNER™ Vertical Cable Management Rack System Maximum Density Minimum Floor Space

*Designed to manage high density cabling while minimizing the area required for the network layout*

- Curved cable manager fingers support patch cords as they transition to vertical pathway, eliminating need for horizontal cable managers
- Integral bend radius control on each cable management finger reduces cable kinks and snags that can harm network performance
- Finger spacing aligns with rack spaces simplifying cable routing
- Slack cable management spools organize patch cord lengths
- Angled modular patch panel promotes proper bend radius control



For additional information on these and other networking product solutions, request catalog SA-NCCB04.



*PANDUIT® offers a selection of PANDUCT® Tools and Accessories to aid cutting, modifying and installing wiring duct.*



Some of the features and benefits found in *PANDUCT®* Tools and Accessories include:

- Wide selection of hand tools for cutting and installing wiring duct
- Snap-in wire retainers to retain cabling when the cover is removed, or during cable installation
- Divider walls that mount within the duct enabling multiple channels to be created within a duct channel
- Corner strips hold corners rigid at tee junctions in control panel applications
- Joining strips to connect two sections of duct and hold the walls rigid
- Mounting clips provide an alternative method to mount the duct and allow the duct to be more easily removed

# Wiring Duct Accessories for Control Panel Applications

Overview

Control Panel

Special Environment

Voice & Data

Tools & Accessories

Technical Info

Index

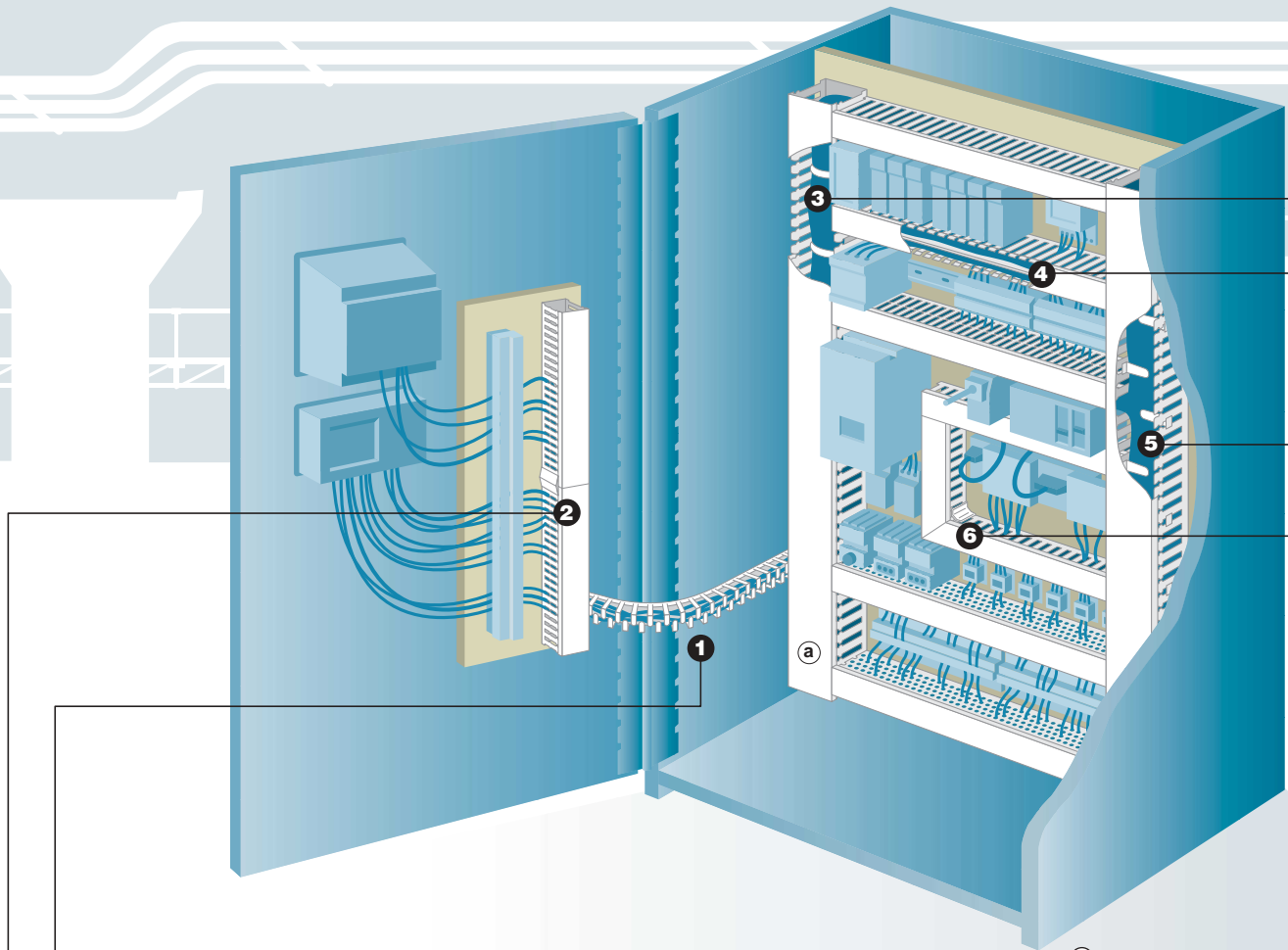

<sup>a</sup> For information on the complete line of PANDUCT® Wiring Duct see [page B1](#)

## 1 Flexible Wiring Duct

PAGE E4

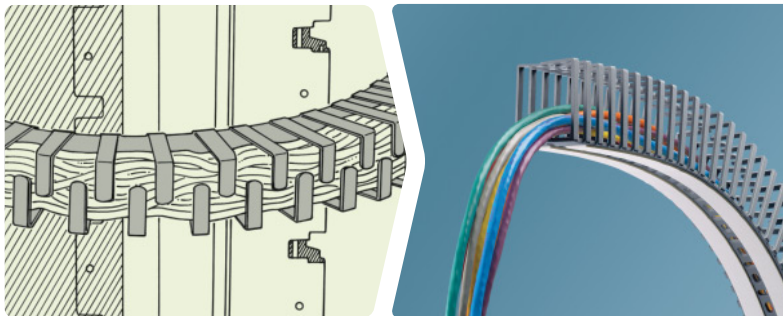

**NEW!**

Flexible one-piece design routes cabling from the panel interior over a hinge to devices on the panel door surface. Adhesive backed.

## 2 Joining Strips

PAGE E8

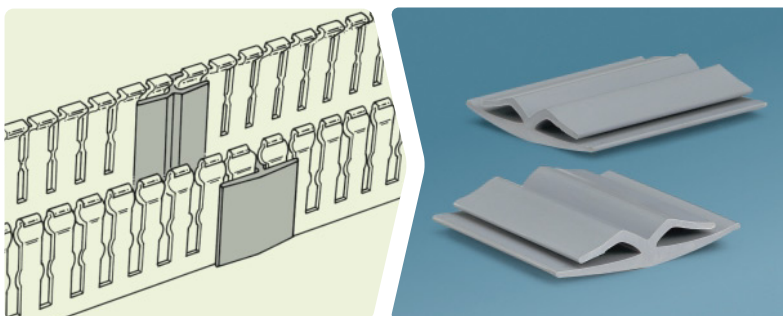

Attach to sections of duct to cover the seam and provide added rigidity to the channel.

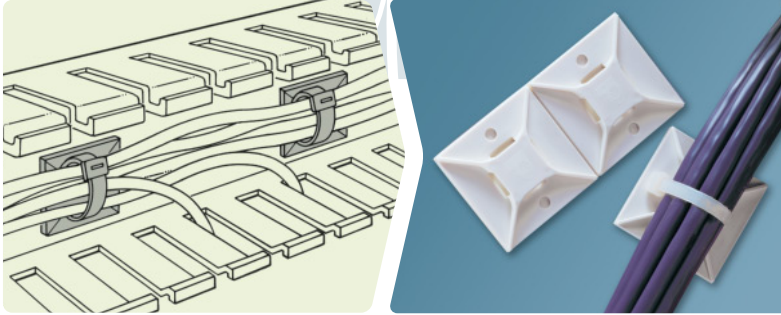
**3 Cable Ties and Mounts****PAGE E11**

Use *PANDUIT*® mounts and cable ties to retain cable bundles within the wiring duct channel.

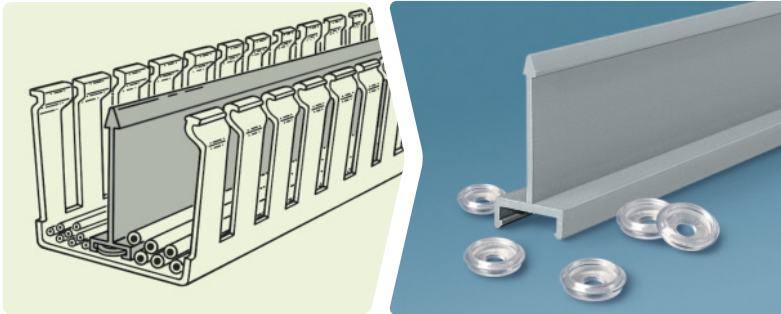
**4 Divider Wall****PAGE E5**

Create separate wiring channels within the wiring duct base. Available in solid or slotted wall styles.

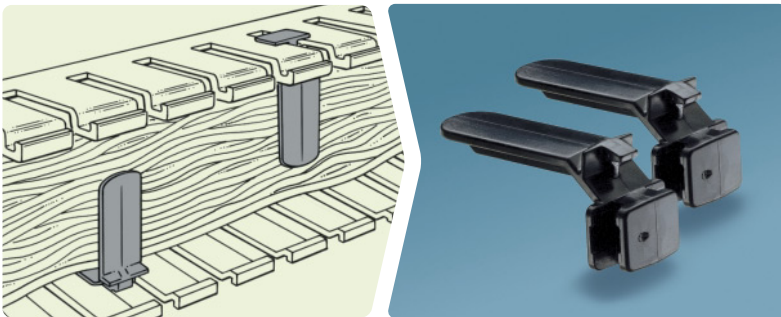
**5 Wire Retainers****PAGE E6**

Install between the duct fingers to retain cabling when cover is removed. Adjustable along finger length to retain large or small wire bundles.

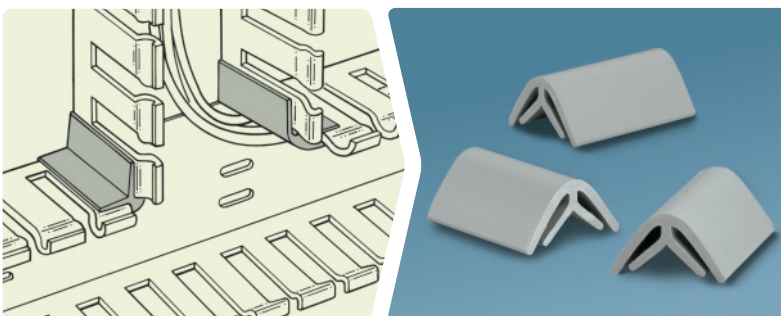
**6 Corner Strips****PAGE E8**

Create a rigid corner at tee junctions and right angles.

# Wiring Duct *Tools & Accessories*

## **NEW!** PANDUCT® Type FL — Flexible Wiring Duct



### Specifications

- Flexible polypropylene material
- UL Recognized continuous use temperatures up to 65°C (149°F)
- UL94 Flammability Rating of V-2
- Factory applied adhesive tape provided for easy mounting

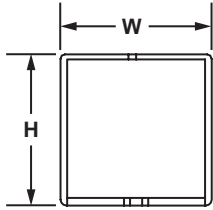

Part Number	Duct Size WxH		Duct Std. Ctn. Qty.	Length (mm)
	mm	In.		
FL12X12LG-A	12.5 x 12.5	.49 x .49	112	500
FL25X25LG-A	25.0 x 25.0	.98 x .98	70	
FL50X50LG-A	50.0 x 50.0	1.97 x 1.97	32	

Available in LG (RAL 7040 Light Gray) color only.

Features	Advantages	Benefits
Flexible	Can be positioned at extreme angles, around corners and over door hinges	Can be used in applications requiring flexibility where conventional wiring duct cannot
Fully enclosed	Wrap-around fingers eliminate the need for a cover	Provides method to retain cables while reducing number of parts needed to stock
Offset fingers	Allows wires to be fed in easily from the top and allows wire lead-in from both sides of the duct	Reduces installation time compared to designs with overlapping fingers

## PANDUCT® Divider Wall

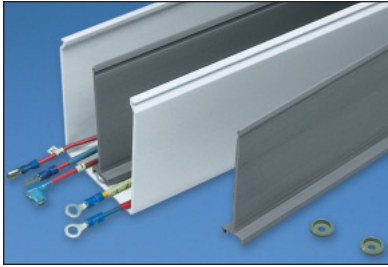

- Wiring duct divider wall can be mounted inside any type of PANDUIT® PVC wiring duct to create multiple channels
- Simply install the divider wall base when mounting the duct and snap the divider wall onto the mounting base accessory (see page E6)
- All versions snap onto DB-C mounting base
- Divider wall heights 2" and greater have a scoreline feature allowing sections to be removed leaving a smooth edge
- Meets UL508/508A insulation material requirement for barrier between conductors

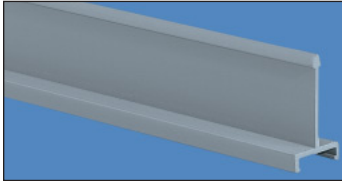

Part Number	For Nominal Duct Height (In.)	Std. Pkg. Qty.	Std. Ctn. Qty.	Length (ft)
-------------	-------------------------------	----------------	----------------	-------------

### Solid Divider Wall for use with all Types of PVC Wiring Duct

D1H6	1.00	6	120	6
D1.5H6	1.50	6	120	6
D2H6	2.00	6	120	6
D3H6	3.00	6	120	6
D4H6	4.00	6	120	6



### Slotted Divider Wall for use with all Types of PVC Wiring Duct

SD2H6	2.00	6	120	6
SD3H6	3.00	6	120	6
SD4H6	4.00	6	120	6

Part Number	For Nominal Duct Height (mm)	Std. Pkg. Qty.	Std. Ctn. Qty.	Length (M)
-------------	------------------------------	----------------	----------------	------------

### Metric Solid Divider Wall for use with Type MC Duct

D50H2	50	2	40	2
D75H2	75	2	40	2
D100H2	100	2	40	2

NOTE: Must be used with Mounting Base (DB-C) which is sold separately. Install mounting bases to the duct channel, locate within 2" of each divider wall end and at least every 12" along the length.

## **NEW!** PANDUCT® Type TMC Low Smoke/Low Toxicity Solid Divider Wall

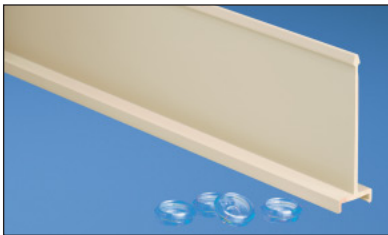

- TMC Divider Wall can be mounted inside TMC Wiring Duct to create multiple channels
- Low smoke, low toxicity and low flammability material
- Simply install the divider wall base when mounting the duct and snap the divider wall onto mounting base (part No. DB-C)

Part Number	For Nominal Duct Height (mm)	Std. Pkg. Qty.	Std. Ctn. Qty.	Length (M)
TMC50DW2	50	2	20	2
TMC75DW2	75	2	20	2

NOTE: Must be used with Mounting Base (DB-C) which is sold separately. Install mounting bases to the duct channel, locate within 2" of each divider wall end and at least every 12" along the length.

Overview

Control Panel

Special Environment

Voice & Data

Tools & Accessories

Technical Info

Index

# Wiring Duct *Tools & Accessories*

## PANDUCT® Mounting Base - Type G, F, FS, D & TMC Wiring Duct



- Installed when mounting duct
- Acts as a shroud around the screw to protect wires from abrasion

Control Panel

Part Number	Part Description	Used with Anchors	Std. Pkg. Qty.	Std. Ctn. Qty.
DB-C	Mounting base.	PANDUIT® NR1 or #8 or #10 screw	100	1000

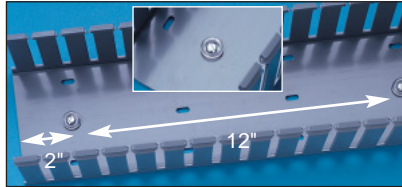

**Installing Base —**  
Install mounting bases to the duct channel, locate within 2" of each divider wall end and at least every 12" along the length.

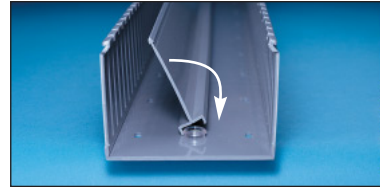

**Installing Divider Wall —**  
Snap the divider wall to the mounting bases already installed.

Special Environment

## PANDUCT® Type G and Type H Wiring Duct Wire Retainers

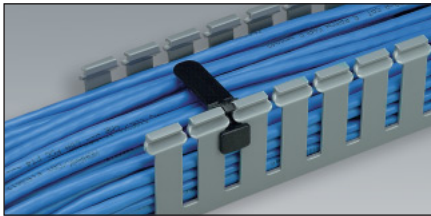

- Inserts between fingers of Type G and Type H Wiring Duct to contain wiring when cover is removed
- Adjustable height
- Made of ABS material

Voice & Data



Part Number	For Duct Width In. (mm)	For Duct Height In. (mm)	Std. Pkg. Qty.	Std. Ctn. Qty.
WR2-C	2.00 (50.8)	2.00 - 4.00 (50.8 - 101.6)	100	1000
WR3-C	3.00 (76.2)	2.00 - 4.00 (50.8 - 101.6)	100	1000
WR4-C	4.00 (101.6)	2.00 - 4.00 (50.8 - 101.6)	100	1000
WR5-C	Use with: 3 x 5, 4 x 5 or 6 x 4	Use with: 3 x 5, 4 x 5 or 6 x 4	100	1000

Tools & Accessories

## PANDUCT® Solid Wall Raceway Type FS and Type D Wiring Duct Wire Retainer

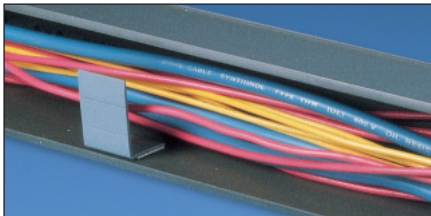

- Mounts onto walls of Type FS Raceway or Type D Wiring Duct with pressure sensitive adhesive
- One size fits three different duct widths
- Full length is used with 2" wide duct; for small widths, break off segments at scorelines
- Made of lead-free PVC material

Technical Info

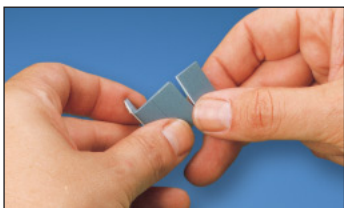

Break off segment

Part Number	For Duct Width In. (mm)	Std. Pkg. Qty.	Std. Ctn. Qty.
WRS-A-C10	1.00 (25.4) 1.50 (38.1) 2.00 (50.8)	100	1000

Index

## PANDUCT® Type F, MC & TMC Wiring Duct Wire Retainers/Labeling Device

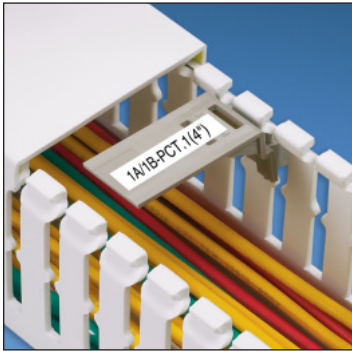

- For use with Type F, MC and TMC Duct to contain wiring when cover is removed
- FWR-C works with all Type F Duct sizes
- FMWR-C works with all Type MC and TMC sizes
- Made of rigid PVC material

Part Number	For Duct Width		Std. Pkg. Qty.	Std. Ctn. Qty.
	In.	mm		
FWR-C	1.50 - 4.00	—	100	1000
FMWR-C	—	37 - 100	100	1000

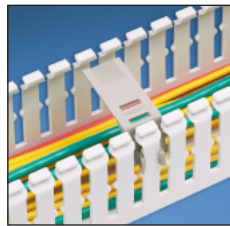

**Wire Retainer —**  
Snaps onto duct fingers. Full length for use with 4" wide duct. For smaller widths, break off segments at scorelines.

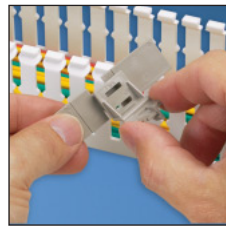

**Labeling Outside Duct —**  
Break off the last segment from wire retainer below (1.5" mark) and snap onto the back of the remaining segment. Install label & mount between fingers facing outward.

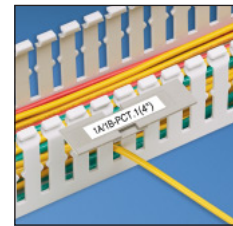

F, MC and TMC Duct Wire Retainers/Labeling Device can be labeled using laser/ink jet computer printable label C188X030FJJ. For more information on label C188X030FJJ and other PANDUIT® Identification and Labeling Solutions, contact PANDUIT® Customer Service and request the PAN-CODE® Identification and Labeling Solutions catalog, SA-101N315C-ID.

## Permanent Marking Pens



- Fast drying permanent ink
- Can be used with write-on labels shown above

Part Number	Part Description	Std. Pkg. Qty.	Std. Ctn. Qty.
PX-0	Permanent marking pen, Regular tip, Black ink.	12	144
PX-2	Permanent marking pen, Regular tip, Red ink.	12	144
PFX-0	Permanent marking pen, Fine tip, Black ink.	12	144
PFX-2	Permanent marking pen, Fine tip, Red ink.	12	144

The TIA/EIA-606-A standard states that all labels shall be mechanically generated. Write-on labels are not standard compliant.

Overview

Control Panel

Special Environment

Voice & Data

Tools & Accessories

Technical Info

Index

# Wiring Duct *Tools & Accessories*

## PANDUCT® Duct Corner Strips

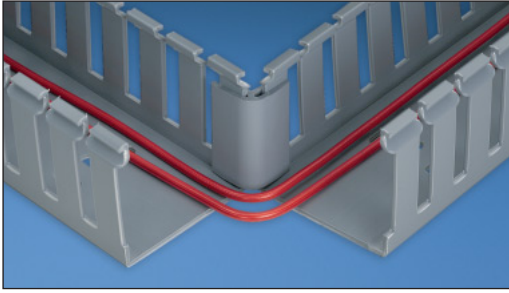

- Slides onto duct at corner or tee junctions for smooth, round corners
- Available in five pre-cut sizes and six-foot lengths that can be cut-to-size to meet any size requirement
- Easy to install one-piece design
- Compatible with all styles of PANDUIT® Wiring Duct
- Made of rigid PVC material



Part Number	Part Description	For Duct Height		Color	Std. Pkg. Qty.	Std. Ctn. Qty.
		In.	mm			

### 6 Foot Lengths for use with all Types of PVC Wiring Duct

<b>CS1LG6</b>	6 foot length is cut by user to fit duct height.	Cut-to-size	Cut-to-size	Light Gray	6	120
---------------	--	-------------	-------------	------------	---	-----

### Pre-Cut Pieces for use with all Types of PVC Wiring Duct

<b>CSP1LG-Q</b>	Pre-cut pieces are cut to size.	1.00	25.4	Light Gray	25	250
<b>CSP1.5LG-Q</b>		1.50	38.1	Light Gray	25	250
<b>CSP2LG-Q</b>		2.00	50.8	Light Gray	25	250
<b>CSP3LG-Q</b>		3.00	76.2	Light Gray	25	250
<b>CSP4LG-Q</b>		4.00	101.6	Light Gray	25	250

Pre-cut pieces available in LG (Light Gray) only.

## PANDUCT® Duct Joining Strips

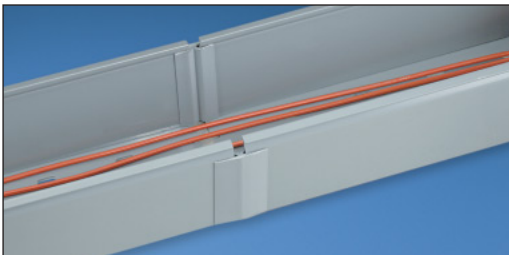

- Slides onto duct to join sections together
- Available in four pre-cut sizes and six-foot lengths that can be cut-to-size to meet any size requirement
- Easy to install one-piece design
- Compatible with all styles of PANDUIT® Wiring Duct
- Made of rigid PVC material



Part Number	Part Description	For Duct Height		Color	Std. Pkg. Qty.	Std. Ctn. Qty.
		In.	mm			

### 6 Foot Lengths for use with all Types of PVC Wiring Duct

<b>DJS1LG6</b>	6 foot length is cut by user to fit duct height.	Cut to size	Cut to size	Light Gray	6	120
<b>DJS1WH6</b>				White		

### Pre-Cut Pieces for use with all Types of PVC Wiring Duct

<b>DJSP1.5LG-Q</b>	Pre-cut pieces are cut to size.	1.50	38.1	Light Gray	25	250
<b>DJSP2LG-Q</b>		2.00	50.8	Light Gray	25	250
<b>DJSP3LG-Q</b>		3.00	76.2	Light Gray	25	250
<b>DJSP4LG-Q</b>		4.00	101.6	Light Gray	25	250

Pre-cut pieces available in LG (Light Gray) only.



## PANDUCT® Snap-Clip Mounting Bracket — Type G, F, FS, D, MC, NNC & TMC Wiring Duct

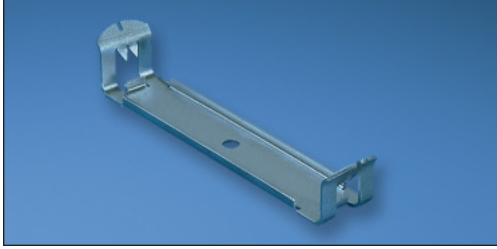

- Duct easily snaps into bracket
- No mounting holes required in duct
- Ensures no metal is inside the duct
- Snap-clip spacing is not critical
- Simplifies fabrication drawings and panel layout

Part Number	Screw Required	For Duct Width		Std. Pkg. Qty.	Std. Ctn. Qty.
		In.	mm		
<b>Snap-Clip Mounting Bracket for use with Types G, F, FS &amp; D Duct</b>					
S1F-C	#8-32 x 1/4 (Provided)	1.00	25.4	100	1000
S1.5F-C	#8-32 x 1/4 (Provided)	1.50	38.1	100	1000
S2F-C	#8-32 x 1/4 (Provided)	2.00	50.8	100	1000
S3F-C	#8-32 x 1/4 (Provided)	3.00	76.2	100	1000
S4F-C	#8-32 x 1/4 (Provided)	4.00	101.6	100	1000
<b>Snap-Clip Mounting Bracket for use with Types MC, NNC &amp; TMC Duct</b>					
SNS25F-C	#8-32 x 1/4 (User Supplied)	1.00	25.4	100	1000
SNS37F-C	#8-32 x 1/4 (User Supplied)	1.50	38.1	100	1000
SNS50F-C	#8-32 x 1/4 (User Supplied)	2.00	50.8	100	1000
SNS62F-C	#8-32 x 1/4 (User Supplied)	3.00	76.2	100	1000

## PANDUCT® Snap-Clip Mounting Bracket — Type NE Wiring Duct



- Duct easily snaps into bracket
- Ensures no metal is inside the duct
- Mounts anywhere along the length of the duct for easy installation
- Simplifies fabrication drawings and panel layout

Part Number	Screw Required	For Duct Width		Std. Pkg. Qty.	Std. Ctn. Qty.
		In.	mm		
SNS.5-C	#6-32 x 1/4 (User Supplied)	.50	12.7	100	1000
SNS.75-C	#6-32 x 1/4 (User Supplied)	.75	19.1	100	1000
SNS1-C	#8-32 x 1/4 (User Supplied)	1.00	25.4	100	1000
SNS1.5-C	#8-32 x 1/4 (User Supplied)	1.50	38.1	100	1000
SNS2-C	#8-32 x 1/4 (User Supplied)	2.00	50.8	100	1000
SNS3-C	#8-32 x 1/4 (User Supplied)	3.00	76.2	100	1000

Overview

Control Panel

Special Environment

Voice & Data

Tools & Accessories

Technical Info

Index

# Wiring Duct *Tools & Accessories*

## PANDUCT® Stud Type Fasteners — For All Duct/Raceway Types



- Secures cover in place during shipping or extreme vibration
- Provides tamper resistance
- Fits into the standard mounting holes available on duct —  
NOTE: .200" (5mm) hole must be drilled in the cover to accommodate the fastener

Control Panel

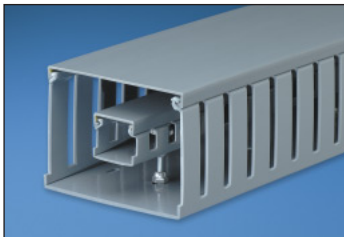

Can also be used to mount a smaller size duct within larger duct to create a completely separate channel within a channel

Special Environment

Part Number	Part Description	Thread size	For Duct Height		Std. Pkg. Qty.
			In.	mm	
F1-C	Corrosion resistant steel stud with fastener.	10/24 threads on each end	1.00	25.4	100
F2-C	Corrosion resistant steel stud with fastener.	10/24 threads on each end	2.00	50.8	100
F3-C	Corrosion resistant steel stud with fastener.	10/24 threads on each end	3.00	76.2	100
F4-C	Corrosion resistant steel stud with fastener.	10/24 threads on each end	4.00	101.6	100

Voice & Data

## PAN-TY® Cable Ties



- Versatile cable ties that can be used in countless applications
- One piece construction for consistent performance and reliability
- High strength and low thread force
- Curved tip makes it easier to pick up from flat surfaces, allows faster initial threading and speeds installation
- Tie bundle diameters up to 13" (330mm) or join together for larger diameters
- Material: Natural Nylon 6.6

Tools & Accessories

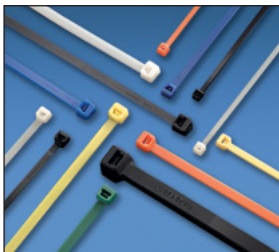

Technical Info

Part Number	Length		Maximum Bundle Diameter		Cross Section	Std. Pkg. Qty.	Std. Ctn. Qty.
	In.	mm	In.	mm			
PLT1M-C	4.0	99	.87	22	Miniature	100	1000
PLT2I-C	8.0	203	2.00	51	Intermediate	100	1000
PLT3I-C	12.0	290	3.00	76	Intermediate	100	1000
PLT2S-C	8.0	188	1.88	48	Standard	100	1000
PLT3S-C	12.0	292	3.00	76	Standard	100	1000
PLT4S-C	15.0	368	4.00	102	Standard	100	1000

Index

## 4-Way Adhesive Backed Mounts



- Superior adhesive for long term reliability
- 2-up mount configuration speeds liner removal and installation
- 4-way cable tie entry makes part orientation fast and easy
- Adhesive backing allows routing of wires and cables where mounting holes cannot be drilled
- Used with *PANDUIT*® cable ties for a complete wire routing solution
- For indoor use



Part Number	Material	Color	Height		Length		Width		Adhesive Type	Max. Static Load		Mounting Method	Used With Cable Ties‡	Std. Pkg. Qty.
			In.	mm	In.	mm	In.	mm		Lbs.	g			
ABMM-A-C	ABS	White	.18	4.6	.75	19.1	.75	19.1	Rubber	.30	136	Adhesive Backed	M, I	100
ABM2S-A-C	ABS	White	.20	5.1	1.00	25.4	1.00	25.4	Rubber	.50	227	Adhesive Backed	M, I, S	100
ABM112-A-C	Nylon 6.6	White	.16	4.2	1.12	28.6	1.12	28.6	Rubber	.63	286	Adhesive Backed	M, I, S	100

‡ Cable Tie Cross Section Sizes: M = Miniature, I = Intermediate, S = Standard, HS = Heavy-Standard, LH = Light-Heavy, H = Heavy, HLM = Miniature *TAK-TY*® Hook & Loop Ties.

## Tie Mounts — Mechanically Applied

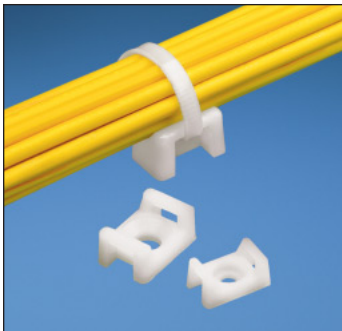

- Install with a screw or rivet for a strong, secure installation
- Available in multiple sizes for a variety of applications
- Unique cradle design provides maximum stability for cable bundle
- Used with *PANDUIT*® cable ties for a complete wire routing solution
- For indoor use

Part Number	Material	Color	Height		Length		Width		Mounting Method	Used With Cable Ties‡	Std. Pkg. Qty.
			In.	mm	In.	mm	In.	mm			
TM2S8-C	Nylon 6.6	Natural	.28	7.0	.63	16.1	.43	10.8	#8 (M4) Screw	M, I, S	100
TM3S8-C	Nylon 6.6	Natural	.38	9.5	.88	22.2	.62	15.8	#8 (M4) Screw	M, I, S, LH	100

‡ Cable Tie Cross Section Sizes: M = Miniature, I = Intermediate, S = Standard, HS = Heavy Standard, LH = Light-Heavy, H = Heavy, HLM = Miniature *TAK-TY*® Hook & Loop Ties.



Overview

Control Panel

Special Environment

Voice & Data

Tools & Accessories

Technical Info

Index

# Wiring Duct *Tools & Accessories*

## Tie Anchor Mounts — Screw Applied

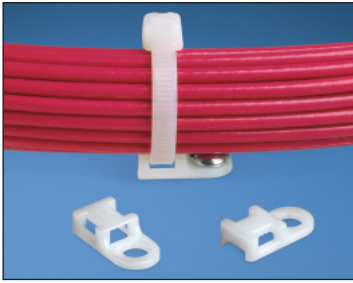

- 4-way cable tie entry makes part orientation fast and easy
- Install with a screw or rivet for a strong, secure installation
- Small overall size allows use where space is limited
- Used with *PANDUIT*® cable ties for a complete wire routing solution
- For indoor use



Part Number	Material	Color	Height		Length		Width		Hole Diameter		Mounting Method	Used With Cable Ties‡	Std. Pkg. Qty.
			In.	mm	In.	mm	In.	mm	In.	mm			
TA1S8-C	Nylon 6.6	Natural	.20	5.0	.38	9.5	.75	19.1	.170	4.3	#8 (M4) Screw	M, I, S	100

‡ Cable Tie Cross Section Sizes: M = Miniature, I = Intermediate, S = Standard, HS = Heavy-Standard, LH = Light-Heavy, H = Heavy, HLM = Miniature TAK-TY® Hook & Loop Ties.

## Low Profile Mounts — Screw Applied



- Install with a screw or rivet for a strong, secure installation
- Counter sunk screw hole will not damage the wire bundle
- Small overall size allows use where space is limited
- Used with *PANDUIT*® cable ties for a complete wire routing solution
- For indoor use



Part Number	Material	Color	Height		Length		Width		Hole Diameter		Mounting Method	Used With Cable Ties‡	Std. Pkg. Qty.
			In.	mm	In.	mm	In.	mm	In.	mm			
LPMS-S8-C	Nylon 6.6	Natural	.12	3.0	.75	19.1	.50	12.7	.180	4.6	#8 (M4) Screw	M, I, S	100

‡ Cable Tie Cross Section Sizes: M = Miniature, I = Intermediate, S = Standard, HS = Heavy-Standard, LH = Light-Heavy, H = Heavy, HLM = Miniature TAK-TY® Hook & Loop Ties.

## Adhesive Tape for Wiring Duct



- Recommended installation temperature is 70°F (21°C)
- UL Recognized service temperature is 32°F (0°C) to 140°F (60°C)
- Optimum recommended dwell time for acrylic adhesive is 8 hours
- Recommended tape load is 1/2 lb. per square inch of tape area

**As a Permanent Mounting Method:**  
Eliminates the drilling and tapping of holes, labor and time required to install separate mounting devices.

**As a Temporary Mounting Method:**  
Holds duct in place to free installer's hands to further secure duct with screws, rivets, etc.

Duct Size W x H	Tape Part Number	Roll Length		Std. Pkg. Qty.	Std. Ctn. Qty.
		Yds.	M		
.5 x .5 thru 1.5 x 4	P32W2A2-50-7	7.0	6.4	1 Roll	100 Rolls
	P32W2A2-50-72	72.0	65.5	1 Roll	9 Rolls
2 x 1 thru 3 x 3	P32W2A2-50-7	7.0	6.4	1 Roll	100 Rolls
	P32W2A2-50-72	72.0	65.5	1 Roll	9 Rolls
3 x 4 thru 3 x 5	P32W2A2-75-7	7.0	6.4	1 Roll	60 Rolls
	P32W2A2-75-72	72.0	65.5	1 Roll	7 Rolls
4 x 1.5 thru 4 x 3	P32W2A2-50-7	7.0	6.4	1 Roll	100 Rolls
	P32W2A2-75-72	72.0	65.5	1 Roll	9 Rolls
4 x 4 thru 6 x 4	P32W2A2-75-7	7.0	6.4	1 Roll	60 Rolls
	P32W2A2-75-72	72.0	65.5	1 Roll	7 Rolls

Order number of rolls required in multiples of Standard Package Quantity.

## Adhesive Tape Guide

Selection of Wiring Duct Part Numbers Available with Factory Applied Adhesive Tape

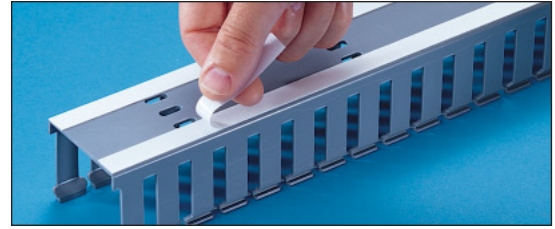

G Duct Light Gray	G Duct White	G Duct Black	F Duct Light Gray	NE Duct White
G.5X.5LG6-A	G.5X.5WH6-A	—	F.5X.5LG6-A	—
G.5X1LG6-A	G.5X1WH6-A	—	F.5X1LG6-A	—
G.75X.75LG6-A	—	—	F.75X.75LG6-A	—
G.75X1LG6-A	G.75X1WH6-A	—	—	—
G.75X1.5LG6-A	G.75X1.5WH6-A	—	F.75X1.5LG6-A	—
G.75X2LG6-A	G.75X2WH6-A	—	—	—
G1X1LG6-A	G1X1WH6-A	—	F1X1LG6-A	—
G1X1.5LG6-A	G1X1.5WH6-A	—	F1X1.5LG6-A	—
G1X2LG6-A	G1X2WH6-A	—	F1X2LG6-A	NE1X2WH6-A
G1X3LG6-A	G1X3WH6-A	G1X3BL6-A	F1X3LG6-A	—
G1X4LG6-A	G1X4WH6-A	—	F1X4LG6-A	—
G1.5X1LG6-A	G1.5X1WH6-A	—	F1.5X1LG6-A	—
G1.5X1.5LG6-A	G1.5X1.5WH6-A	—	F1.5X1.5LG6-A	—
G1.5X2LG6-A	G1.5X2WH6-A	—	F1.5X2LG6-A	NE1.5X2WH6-A
G1.5X3LG6-A	G1.5X3WH6-A	—	F1.5X3LG6-A	—
G1.5X4LG6-A	G1.5X4WH6-A	—	F1.5X4LG6-A	—
G2X1LG6-A	G2X1WH6-A	—	F2X1LG6-A	—
G2X1.5LG6-A	G2X1.5WH6-A	—	F2X1.5LG6-A	—
G2X2LG6-A	G2X2WH6-A	G2X2BL6-A	F2X2LG6-A	NE2X2WH6-A
G2X3LG6-A	G2X3WH6-A	—	F2X3LG6-A	—
G2X4LG6-A	G2X4WH6-A	G2X4BL6-A	F2X4LG6-A	—
G2X5LG6-A	G2X5WH6-A	—	F2X5LG6-A	—
G2.5X3LG6-A	G2.5X3WH6-A	—	—	—
G3X1LG6-A	G3X1WH6-A	—	F3X1LG6-A	NE3X1WH6-A
G3X2LG6-A	G3X2WH6-A	—	F3X2LG6-A	—
G3X3LG6-A	G3X3WH6-A	G3X3BL6-A	F3X3LG6-A	—
G3X4LG6-A	G3X4WH6-A	—	F3X4LG6-A	—
G3X5LG6-A	G3X5WH6-A	—	F3X5LG6-A	—
G4X1.5LG6-A	G4X1.5WH6-A	—	—	—
G4X2LG6-A	G4X2WH6-A	—	F4X2LG6-A	NE4X2WH6-A
G4X3LG6-A	G4X3WH6-A	—	F4X3LG6-A	NE4X3WH6-A
G4X4LG6-A	G4X4WH6-A	G4X4BL6-A	F4X4LG6-A	NE4X4WH6-A
G4X5LG6-A	G4X5WH6-A	—	F4X5LG6-A	—

\*All 3 sizes of Flexible Duct come provided with adhesive: FL12X12LG-A, FL25X25LG-A, FL50X50LG-A

### Specifications for Factory Applied Tape

Duct Size WxH	Rows of Tape	Tape			
		Width		Thickness	
		In.	mm	In.	mm
.5 x .5 through 1.5 x 4	1	.50	12.7	.03	.8
2 x 1 through 3 x 3	2	.50	12.7	.03	.8
3 x 4 through 3 x 5	2	.75	19.1	.03	.8
4 x 1.5 through 4 x 3	2	.50	12.7	.03	.8
4 x 4 through 6 x 4	2	.75	19.1	.03	.8

# Wiring Duct *Tools*

## PANDUCT® Cutting Tool



- Easily cuts any PANDUCT® duct and cover

Control Panel

Part Number	Part Description	Std. Pkg. Qty.
DCT	Hand held duct cutting tool.	1
DCT-BLD	Replacement blade kit with blade and nylon insert.	1
DCT-RI	Replacement nylon insert.	5

Always use approved safety goggles when using any tools.



DCT-BLD



DCT-RI

Special Environment



Use to cut any PANDUCT® Duct or Cover.



Cut cover as shown, latch side-up.

Voice & Data

## PANDUCT® Duct Finger Cutting Tool



- Easily removes duct fingers in tight places
- For use with all slotted wiring duct

Tools & Accessories

Part Number	Part Description	Std. Pkg. Qty.
DFCT	Hand held duct finger cutting tool.	1

Always use approved safety goggles when using any tools.

Technical Info



Index

## PANDUCT® Notching Tool



- Notches duct sidewalls to bottom scoreline for tee and corner junctions

Part Number	Part Description	Std. Pkg. Qty.
DNT-100	Hand held sidewall notching tool.	1

Always use approved safety goggles when using any tools.

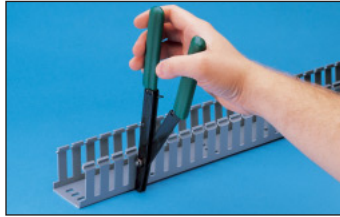

Step 1 — Notch wiring duct sidewall at the desired opening width.

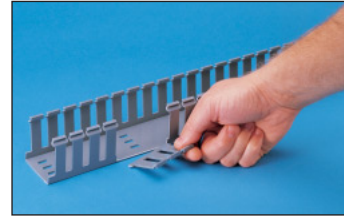

Step 2 — Snap off notched wiring duct piece at bottom scoreline.

## PANDUCT® Nylon Rivet Installation Tool



TNR

- Installs PANDUIT® Nylon Rivets (NR1) quickly and easily

Part Number	Part Description	Std. Pkg. Qty.
TNR	Hand held nylon rivet installation tool.	1

### Nylon Rivets

NR1-C	Nylon rivet for use with TNR Rivet Tool.	100
NR1-M	Nylon rivet for use with TNR Rivet Tool.	1000

Always use approved safety goggles when using any tools.



NR1

Total Thickness of Panel and Duct		Panel Hole Dia. Needed	
In.	mm	In.	mm
.158 - .187	4.0 - 4.7	.18	4.7
.188 - .218	4.8 - 5.5	.19	4.9
.219 - .250	5.6 - 6.4	.20	5.2
.251 and up	6.5 and up	.21	5.4

- Fast, lowest cost mounting method
- Installs quickly and easily using PANDUIT® Rivet Installation Tool (TNR)

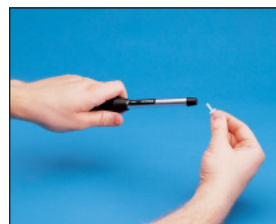

Step 1 — Insert rivet in tool.



Step 2 — Position rivet into hole.



Step 3 — Install rivet with sharp tap.

Overview

# Wiring Duct *Tools & Accessories*

## **Notes**

Control  
Panel

Special  
Environment

Voice &  
Data

Tools &  
Accessories

Technical  
Info

Index



PANDUIT® provides detailed technical information to assist in selecting and specifying the proper Wiring Duct:

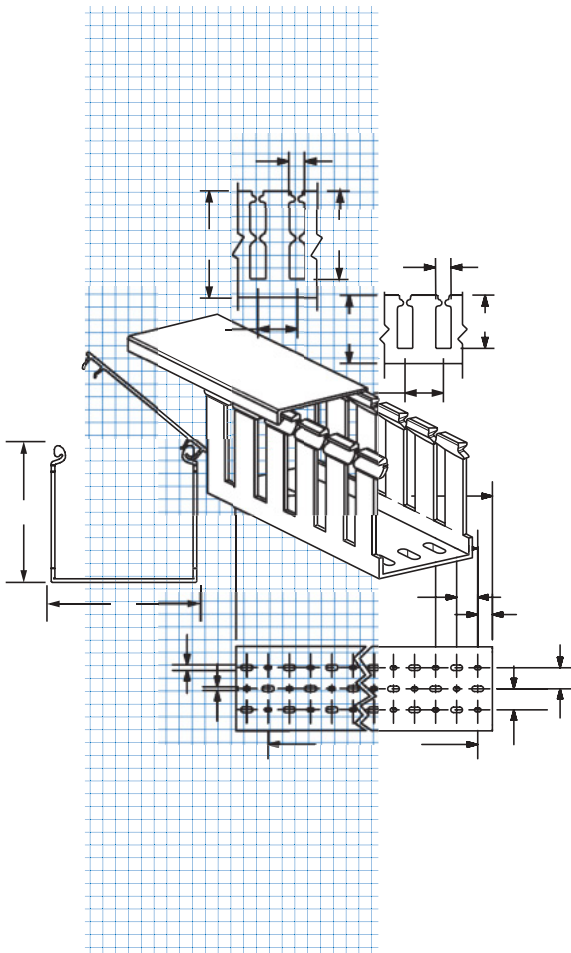

## Wiring Duct Dimensional Information

- Types G & D Wiring Duct .....F2
- Type F Wiring Duct & Type FS Raceway .....F3
- Types MC & TMC Wiring Duct .....F4
- Type NNC Wiring Duct .....F5
- Type NE Wiring Duct .....F6
- Type H & Type FL Wiring Duct .....F7

## Wirefill Capacity Information

- Types G, F & FS Wiring Duct .....F8
- Types MC, NNC & TMC Wiring Duct .....F9
- Type H Wiring Duct .....F9
- Type FL Wiring Duct .....F9
- Type NE Wiring Duct .....F10
- Wirefill Formula Explanation .....F11

## Technical Information

- UL94 Vertical Burning Test .....F12
- Material Specifications .....F13
- Color Selection Guide .....F14
- Installation Tips .....F15



## PANDUCT® Type F Wiring Duct & FS Raceway Dimensions

Dimensions are shown for reference only. Contact customer service (see page footnote) for specific dimensional needs.

For .5", .75", 1" and 1.5" high duct.

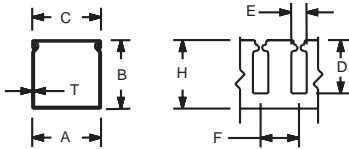

For 2", 3", 4" and 5" high duct.

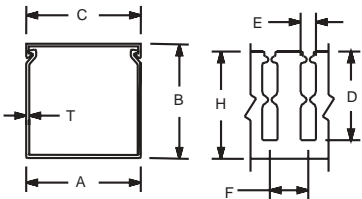

Note: 'A' dimension is measured at base.  
Note: 'K' dimension shown in mounting hole dimensions below.

**Mounting Hole Dimensions**  
For .5", .75", 1" and 1.5" wide duct.

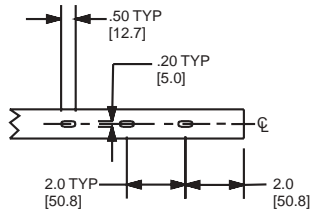

For 2.0", 2.5", 3", 4" and 6" wide duct.

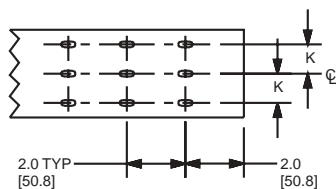

Note: For Type FS Raceway, no mounting holes is the standard condition; if mounting holes are required, delete NM from the Part Number.

DUCT SIZE (W x H)	DIMENSIONS — Inches (mm)								K	T
	A	B	C	D	E	F	H			
.5 x .5 (12.7) (12.7)	0.69 (17.5)	0.60 (15.2)	0.69 (17.5)	0.38 (9.5)	0.20 (5.0)	0.50 (12.7)	0.50 (12.7)	ON CENTERLINE	0.05 (1.3)	
.5 x 1 (12.7) (25.4)	0.69 (17.5)	1.06 (26.9)	0.69 (17.5)	0.75 (19.1)	0.20 (5.0)	0.50 (12.7)	1.00 (25.4)		0.05 (1.3)	
.75 x .75 (19.1) (19.1)	0.93 (23.6)	0.82 (20.8)	0.94 (23.9)	0.56 (14.3)	0.20 (5.0)	0.50 (12.7)	0.75 (19.1)		0.06 (1.4)	
.75 x 1.5 (19.1) (38.1)	0.93 (23.6)	1.57 (39.9)	0.94 (23.9)	1.20 (30.5)	0.20 (5.0)	0.50 (12.7)	1.50 (38.1)		0.07 (1.8)	
1 x 1 (25.4) (25.4)	1.26 (32.0)	1.12 (28.4)	1.25 (31.8)	0.75 (19.1)	0.20 (5.0)	0.50 (12.7)	1.00 (25.4)		0.06 (1.4)	
1 x 1.5 (25.4) (38.1)	1.26 (32.0)	1.62 (41.1)	1.25 (31.8)	1.20 (30.5)	0.20 (5.0)	0.50 (12.7)	1.50 (38.1)		0.07 (1.8)	
1 x 2 (25.4) (50.8)	1.26 (32.0)	2.12 (53.8)	1.25 (31.8)	1.63 (41.3)	0.20 (5.0)	0.50 (12.7)	2.00 (50.8)		0.08 (2.0)	
1 x 3 (25.4) (76.2)	1.26 (32.0)	3.12 (79.2)	1.25 (31.8)	2.63 (66.7)	0.20 (5.0)	0.50 (12.7)	3.00 (76.2)		0.10 (2.4)	
1 x 4 (25.4) (101.6)	1.26 (32.0)	4.10 (104.1)	1.25 (31.8)	3.63 (92.1)	0.20 (5.0)	0.50 (12.7)	4.00 (101.6)		0.11 (2.7)	
1.5 x 1 (38.1) (25.4)	1.75 (44.5)	1.12 (28.4)	1.75 (44.5)	0.75 (19.1)	0.20 (5.0)	0.50 (12.7)	1.00 (25.4)		0.06 (1.5)	
1.5 x 1.5 (38.1) (38.1)	1.75 (44.5)	1.62 (41.1)	1.75 (44.5)	1.20 (30.5)	0.20 (5.0)	0.50 (12.7)	1.50 (38.1)		0.07 (1.8)	
1.5 x 2 (38.1) (50.8)	1.75 (44.5)	2.12 (53.8)	1.75 (44.5)	1.63 (41.3)	0.20 (5.0)	0.50 (12.7)	2.00 (50.8)		0.08 (2.0)	
1.5 x 3 (38.1) (76.2)	1.75 (44.5)	3.12 (79.2)	1.75 (44.5)	2.63 (66.7)	0.20 (5.0)	0.50 (12.7)	3.00 (76.2)		0.10 (2.4)	
1.5 x 4 (38.1) (101.6)	1.75 (44.5)	4.10 (104.1)	1.75 (44.5)	3.63 (92.1)	0.20 (5.0)	0.50 (12.7)	4.00 (101.6)		0.11 (2.7)	
2 x 1 (50.8) (25.4)	2.25 (57.2)	1.12 (28.4)	2.25 (57.2)	0.75 (19.1)	0.20 (5.0)	0.50 (12.7)	1.00 (25.4)		0.06 (1.5)	
2 x 1.5 (50.8) (38.1)	2.25 (57.2)	1.62 (41.1)	2.25 (57.2)	1.20 (30.5)	0.20 (5.0)	0.50 (12.7)	1.50 (38.1)		0.07 (1.8)	
2 x 2 (50.8) (50.8)	2.25 (57.2)	2.12 (53.8)	2.25 (57.2)	1.63 (41.3)	0.20 (5.0)	0.50 (12.7)	2.00 (50.8)		0.08 (2.0)	
2 x 3 (50.8) (76.2)	2.25 (57.2)	3.12 (79.2)	2.25 (57.2)	2.63 (66.7)	0.20 (5.0)	0.50 (12.7)	3.00 (76.2)		0.10 (2.4)	
2 x 4 (50.8) (101.6)	2.25 (57.2)	4.10 (104.1)	2.25 (57.2)	3.63 (92.1)	0.20 (5.0)	0.50 (12.7)	4.00 (101.6)		0.11 (2.7)	
2 x 5 (50.8) (127.0)	2.25 (57.2)	5.10 (129.5)	2.25 (57.2)	4.63 (117.5)	0.20 (5.0)	0.50 (12.7)	5.00 (127.0)		0.12 (2.9)	
3 x 1 (76.2) (25.4)	3.25 (82.6)	1.12 (28.4)	3.25 (82.6)	0.75 (19.1)	0.20 (5.0)	0.50 (12.7)	1.00 (25.4)	0.07 (1.7)		
3 x 2 (76.2) (50.8)	3.25 (82.6)	2.12 (53.8)	3.25 (82.6)	1.63 (41.3)	0.20 (5.0)	0.50 (12.7)	2.00 (50.8)	0.08 (2.0)		
3 x 3 (76.2) (76.2)	3.25 (82.6)	3.12 (79.2)	3.25 (82.6)	2.63 (66.7)	0.20 (5.0)	0.50 (12.7)	3.00 (76.2)	0.10 (2.4)		
3 x 4 (76.2) (101.6)	3.25 (82.6)	4.10 (104.1)	3.25 (82.6)	3.63 (92.1)	0.20 (5.0)	0.50 (12.7)	4.00 (101.6)	0.11 (2.7)		
3 x 5 (76.2) (127.0)	3.25 (82.6)	5.10 (129.5)	3.25 (82.6)	4.63 (117.5)	0.20 (5.0)	0.50 (12.7)	5.00 (127.0)	0.12 (2.9)		
4 x 1.5 (101.6) (38.1)	4.25 (108.0)	1.62 (41.1)	4.25 (108.0)	N/A	N/A	N/A	1.50 (38.1)	0.07 (1.8)		
4 x 2 (101.6) (50.8)	4.25 (108.0)	2.12 (53.8)	4.25 (108.0)	1.63 (41.3)	0.20 (5.0)	0.50 (12.7)	2.00 (50.8)	0.08 (2.0)		
4 x 3 (101.6) (76.2)	4.25 (108.0)	3.12 (79.2)	4.25 (108.0)	2.63 (66.7)	0.20 (5.0)	0.50 (12.7)	3.00 (76.2)	0.10 (2.4)		
4 x 4 (101.6) (101.6)	4.25 (108.0)	4.10 (104.1)	4.25 (108.0)	3.63 (92.1)	0.20 (5.0)	0.50 (12.7)	4.00 (101.6)	0.11 (2.7)		
4 x 5 (101.6) (127.0)	4.25 (108.0)	5.10 (129.5)	4.25 (108.0)	4.63 (117.5)	0.20 (5.0)	0.50 (12.7)	5.00 (127.0)	0.12 (2.9)		
6 x 4 (152.4) (101.6)	6.25 (158.8)	4.15 (105.4)	6.25 (158.8)	N/A	N/A	N/A	4.00 (101.6)	0.11 (2.8)		

> Available for Type FS Duct only.  
See page F14 for wiring duct color and size availability.

# Wiring Duct *Technical Info*

## PANDUCT® Type MC & TMC Wiring Duct Dimensions

Dimensions are shown for reference only. Contact customer service (see page footnote) for specific dimensional needs.

Control Panel

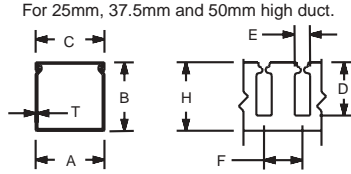

For 62.5mm, 75mm and 100mm high duct.

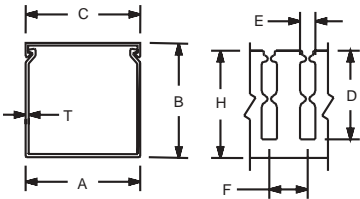

Special Environment

Data & Voice

Note: 'A' dimension is measured at base.  
Note: 'K' dimension shown in mounting hole dimensions below.

### Mounting Hole Dimensions

For 25mm, 37.5mm and 50mm width duct.

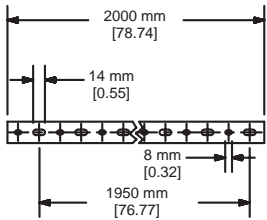

For 75mm and 100mm width duct.

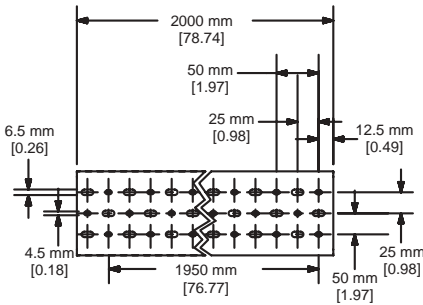

Tools & Accessories

Technical Info

DUCT SIZE (W x H)	DIMENSIONS — mm (Inches)								K	T
	A	B	C	D	E	F	H			
25 x 25 (.98) x (.98)	24.6 (0.97)	23.6 (0.93)	24.6 (0.97)	13.6 (0.54)	5.0 (0.20)	12.5 (0.49)	20.5 (0.81)	ON CENTERLINE	1.4 (0.06)	
25 x 37.5 (.98) x (1.48)	24.6 (0.97)	35.8 (1.41)	24.6 (0.97)	24.7 (0.97)	5.0 (0.20)	12.5 (0.49)	33.0 (1.30)		1.4 (0.06)	
25 x 50 (.98) x (1.97)	24.6 (0.97)	47.8 (1.88)	24.6 (0.97)	34.8 (1.37)	5.0 (0.20)	12.5 (0.49)	45.5 (1.79)		1.5 (0.06)	
25 x 62.5 (.98) x (2.46)	24.6 (0.97)	59.7 (2.35)	24.6 (0.97)	45.8 (1.80)	5.0 (0.20)	12.5 (0.49)	58.0 (2.28)		1.5 (0.06)	
25 x 75 (.98) x (2.95)	24.6 (0.97)	73.2 (2.88)	24.6 (0.97)	57.6 (2.27)	5.0 (0.20)	12.5 (0.49)	70.5 (2.78)		1.7 (0.07)	
37.5 x 37.5 (1.48) x (1.48)	37.1 (1.46)	35.8 (1.41)	37.1 (1.46)	24.7 (0.97)	5.0 (0.20)	12.5 (0.49)	33.0 (1.30)		1.5 (0.06)	
37.5 x 50 (1.48) x (1.97)	37.1 (1.46)	47.8 (1.88)	37.1 (1.46)	34.8 (1.37)	5.0 (0.20)	12.5 (0.49)	45.5 (1.79)		1.7 (0.07)	
37.5 x 62.5 (1.48) x (2.46)	37.1 (1.46)	59.7 (2.35)	37.1 (1.46)	45.8 (1.80)	5.0 (0.20)	12.5 (0.49)	58.0 (2.28)		1.7 (0.07)	
37.5 x 75 (1.48) x (2.95)	37.1 (1.46)	72.4 (2.85)	37.1 (1.46)	57.6 (2.27)	5.0 (0.20)	12.5 (0.49)	70.5 (2.78)		1.8 (0.07)	
50 x 50 (1.97) x (1.97)	49.5 (1.95)	48.0 (1.89)	49.6 (1.95)	34.8 (1.37)	5.0 (0.20)	12.5 (0.49)	45.5 (1.79)		1.7 (0.07)	
50 x 75 (1.97) x (2.95)	49.5 (1.95)	72.4 (2.85)	49.6 (1.95)	57.6 (2.27)	5.0 (0.20)	12.5 (0.49)	70.5 (2.78)		1.9 (0.08)	
50 x 100 (1.97) x (3.94)	49.5 (1.95)	97.8 (3.85)	49.6 (1.95)	81.0 (3.19)	5.0 (0.20)	12.5 (0.49)	95.5 (3.76)		2.2 (0.09)	
62.5 x 37.5 (2.46) x (1.48)	62.0 (2.44)	35.8 (1.41)	62.1 (2.44)	24.7 (0.97)	5.0 (0.20)	12.5 (0.49)	33.0 (1.30)	1.7 (0.07)		
62.5 x 62.5 (2.46) x (2.46)	62.0 (2.44)	59.7 (2.35)	62.1 (2.44)	45.8 (1.80)	5.0 (0.20)	12.5 (0.49)	58.0 (2.28)	1.8 (0.07)		
75 x 50 (2.95) x (1.97)	74.7 (2.94)	48.0 (1.89)	74.6 (2.94)	34.8 (1.37)	5.0 (0.20)	12.5 (0.49)	45.5 (1.79)	25.0 (0.98)	2.0 (0.08)	
75 x 62.5 (2.95) x (2.46)	74.7 (2.94)	59.7 (2.35)	74.6 (2.94)	45.8 (1.80)	5.0 (0.20)	12.5 (0.49)	58.0 (2.28)	25.0 (0.98)	2.0 (0.08)	
75 x 75 (2.95) x (2.95)	74.7 (2.94)	73.2 (2.88)	74.6 (2.94)	57.6 (2.27)	5.0 (0.20)	12.5 (0.49)	70.5 (2.78)	25.0 (0.98)	2.2 (0.09)	
75 x 100 (2.95) x (3.94)	74.7 (2.94)	97.8 (3.85)	74.6 (2.94)	81.0 (3.19)	5.0 (0.20)	12.5 (0.49)	95.5 (3.76)	25.0 (0.98)	2.3 (0.09)	
100 x 50 (3.94) x (1.97)	99.6 (3.92)	48.0 (1.89)	99.6 (3.92)	34.8 (1.37)	5.0 (0.20)	12.5 (0.49)	45.5 (1.79)	25.0 (0.98)	2.0 (0.08)	
100 x 62.5 (3.94) x (2.46)	99.6 (3.92)	59.7 (2.35)	99.6 (3.92)	45.8 (1.80)	5.0 (0.20)	12.5 (0.49)	58.0 (2.28)	25.0 (0.98)	2.0 (0.08)	
100 x 75 (3.94) x (2.95)	99.6 (3.92)	73.2 (2.88)	99.6 (3.92)	57.6 (2.27)	5.0 (0.20)	12.5 (0.49)	70.5 (2.78)	25.0 (0.98)	2.5 (0.10)	
100 x 100 (3.94) x (3.94)	99.6 (3.92)	97.8 (3.85)	99.6 (3.92)	81.0 (3.19)	5.0 (0.20)	12.5 (0.49)	95.5 (3.76)	25.0 (0.98)	2.5 (0.10)	

> Available for Type MC Duct only.

Index

## PANDUCT® Type NNC Wiring Duct Dimensions

Dimensions are shown for reference only. Contact customer service (see page footnote) for specific dimensional needs.

For 25mm, 37.5mm and 50mm high duct.

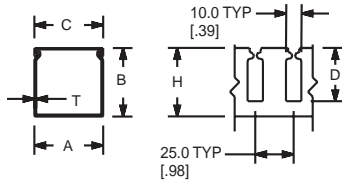

For 75mm and 100mm high duct.

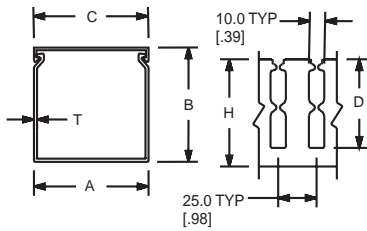

### Mounting Hole Dimensions

For 25mm, 37.5mm and 50mm width duct.

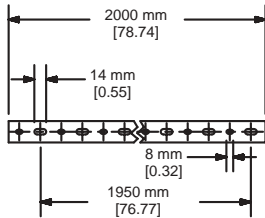

For 75mm and 100mm width duct.

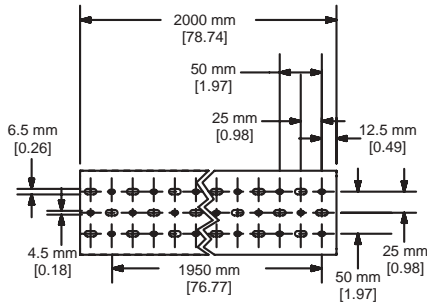

DUCT SIZE (W x H)	DIMENSIONS – mm (Inches)					
	A	B	C	D	H	K
25 x 25 (.98) x (.98)	24.6 (0.97)	23.6 (0.93)	24.6 (0.97)	13.6 (0.54)	20.3 (0.80)	1.5 (0.06)
25 x 37 (.98) x (1.48)	24.6 (0.97)	35.8 (1.41)	24.6 (0.97)	24.6 (0.97)	33.0 (1.30)	1.8 (0.07)
25 x 50 (.98) x (1.97)	24.6 (0.97)	47.8 (1.88)	24.6 (.97)	34.8 (1.37)	45.5 (1.79)	2.0 (0.08)
25 x 75 (.98) x (2.95)	24.6 (0.97)	72.4 (2.85)	24.6 (0.97)	57.6 (2.27)	70.6 (2.78)	2.0 (0.08)
37.5 x 37.5 (1.48) x (1.48)	37.1 (1.46)	35.8 (1.41)	37.1 (1.46)	24.7 (0.97)	33.0 (1.30)	1.8 (0.07)
37.5 x 50 (1.48) x (1.97)	37.1 (1.46)	47.8 (1.88)	37.1 (1.46)	34.8 (1.37)	45.5 (1.79)	2.0 (0.08)
37.5 x 75 (1.48) x (2.95)	37.1 (1.46)	72.4 (2.85)	37.1 (1.46)	57.6 (2.27)	70.6 (2.78)	2.0 (0.08)
50 x 50 (1.97) x (1.97)	49.5 (1.95)	47.8 (1.88)	49.5 (1.95)	34.8 (1.37)	45.5 (1.79)	2.0 (0.08)
50 x 75 (1.97) x (2.95)	49.5 (1.95)	72.4 (2.85)	49.5 (1.95)	57.6 (2.27)	70.6 (2.78)	2.0 (0.08)
50 x 100 (1.97) x (3.94)	49.5 (1.95)	97.8 (3.85)	49.5 (1.95)	81.0 (3.19)	95.5 (3.76)	2.3 (0.09)
75 x 75 (2.95) x (2.95)	74.7 (2.94)	72.4 (2.85)	74.7 (2.94)	57.6 (2.27)	70.6 (2.78)	2.0 (0.08)
100 x 50 (3.94) x (1.97)	99.6 (3.92)	47.8 (1.88)	99.6 (3.92)	34.8 (1.37)	45.5 (1.79)	2.0 (0.08)
100 x 75 (3.94) x (2.95)	99.6 (3.92)	72.4 (2.85)	99.6 (3.92)	57.6 (2.27)	70.6 (2.78)	2.0 (0.08)
100 x 100 (3.92) x (3.85)	99.6 (3.92)	97.8 (3.85)	99.6 (3.92)	81.0 (3.19)	95.5 (3.76)	2.3 (0.09)

Control Panel

Special Environment

Data & Voice

Tools & Accessories

Technical Info

Index

# Wiring Duct *Technical Info*

## PANDUCT® Type NE Wiring Duct Dimensions

Dimensions are shown for reference only. Contact customer service (see page footnote) for specific dimensional needs.

Control Panel

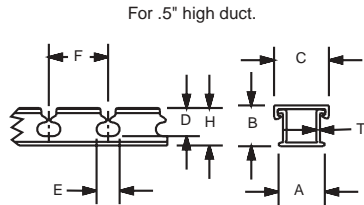

Special Environment

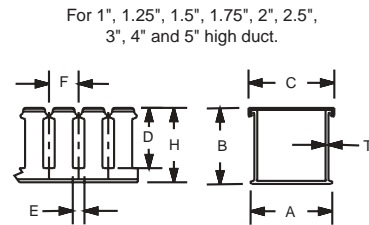

Data & Voice

**Mounting Hole Dimensions**  
For 0.5", 0.75", 1", and 1.5" wide duct.

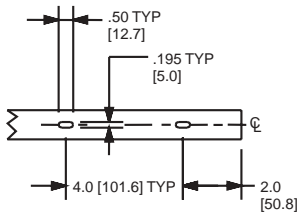

For 2.0", 2.5", 3" and 4" wide duct.

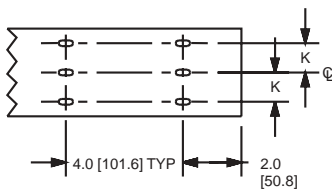

Tools & Accessories

Technical Info

DUCT SIZE (W x H)	DIMENSIONS — Inches (mm)								K	T
	A	B	C	D	E	F	H			
.5 x .5 (12.7) (12.7)	0.63 (16.0)	0.56 (14.2)	0.69 (17.5)	0.38 (9.7)	0.37 (9.4)	0.80 (20.3)	0.50 (12.7)	ON CENTERLINE	0.05 (1.3)	
.5 x 1 (12.7) (25.4)	0.63 (16.0)	1.06 (26.9)	0.69 (17.5)	0.75 (19.1)	0.31 (7.9)	0.80 (20.3)	1.00 (25.4)		0.06 (1.5)	
1 x 1 (25.4) (25.4)	1.14 (29.0)	1.06 (26.9)	1.25 (31.8)	0.75 (19.1)	0.31 (7.9)	0.80 (20.3)	1.00 (25.4)		0.06 (1.5)	
1 x 1.5 (25.4) (38.1)	1.14 (29.0)	1.62 (41.1)	1.25 (31.8)	1.20 (30.5)	0.31 (7.9)	0.80 (20.3)	1.50 (38.1)		0.07 (1.8)	
1 x 2 (25.4) (50.8)	1.14 (29.0)	2.06 (52.3)	1.25 (31.8)	1.63 (41.4)	0.31 (7.9)	0.80 (20.3)	2.00 (50.8)		0.07 (1.8)	
1 x 3 (25.4) (76.2)	1.14 (29.0)	3.06 (77.7)	1.25 (31.8)	2.63 (66.8)	0.31 (7.9)	1.00 (25.4)	3.00 (76.2)		0.07 (1.8)	
1 x 4 (25.4) (101.6)	1.14 (29.0)	4.06 (103.1)	1.25 (31.8)	3.63 (92.2)	0.31 (7.9)	1.00 (25.4)	4.00 (101.6)		0.08 (2.0)	
1.5 x 1.5 (38.1) (38.1)	1.64 (41.7)	1.62 (41.1)	1.75 (44.5)	1.20 (30.5)	0.31 (7.9)	0.80 (20.3)	1.50 (38.1)		0.07 (1.8)	
1.5 x 2 (38.1) (50.8)	1.64 (41.7)	2.06 (52.3)	1.75 (44.5)	1.63 (41.4)	0.31 (7.9)	0.80 (20.3)	2.00 (50.8)		0.07 (1.8)	
1.5 x 3 (38.1) (76.2)	1.64 (41.7)	3.06 (77.7)	1.75 (44.5)	2.63 (66.8)	0.31 (7.9)	1.00 (25.4)	3.00 (76.2)		0.07 (1.8)	
1.5 x 4 (38.1) (101.6)	1.64 (41.7)	4.06 (103.1)	1.75 (44.5)	3.63 (92.2)	0.31 (7.9)	1.00 (25.4)	4.00 (101.6)		0.08 (2.0)	
2 x 1 (50.8) (25.4)	2.14 (54.4)	1.06 (26.9)	2.25 (57.2)	0.75 (19.1)	0.31 (7.9)	0.80 (20.3)	1.00 (25.4)		0.50 (12.7)	0.06 (1.5)
2 x 2 (50.8) (50.8)	2.14 (54.4)	2.06 (52.3)	2.25 (57.2)	1.63 (41.4)	0.31 (7.9)	0.80 (20.3)	2.00 (50.8)	0.50 (12.7)	0.07 (1.8)	
2 x 3 (50.8) (76.2)	2.14 (54.4)	3.06 (77.7)	2.25 (57.2)	2.63 (66.8)	0.31 (7.9)	1.00 (25.4)	3.00 (76.2)	0.50 (12.7)	0.07 (1.8)	
2 x 4 (50.8) (101.6)	2.14 (54.4)	4.06 (103.1)	2.25 (57.2)	3.63 (92.2)	0.31 (7.9)	1.00 (25.4)	4.00 (101.6)	0.50 (12.7)	0.08 (2.0)	
2.5 x 3 (63.5) (76.2)	2.64 (67.1)	3.06 (77.7)	2.75 (69.9)	2.63 (66.8)	0.31 (7.9)	1.00 (25.4)	3.00 (76.2)	0.75 (19.1)	0.07 (1.8)	
3 x 1 (76.2) (25.4)	3.14 (79.8)	1.06 (26.9)	3.25 (82.6)	.75 (19.1)	.31 (7.9)	0.80 (20.3)	1.00 (25.4)	1.00 (25.4)	0.06 (1.5)	
3 x 2 (76.2) (50.8)	3.14 (79.8)	2.06 (52.3)	3.25 (82.6)	1.63 (41.4)	0.31 (7.9)	0.80 (20.3)	2.00 (50.8)	1.00 (25.4)	0.07 (1.7)	
3 x 3 (76.2) (76.2)	3.14 (79.8)	3.06 (77.7)	3.25 (82.6)	2.63 (66.8)	0.31 (7.9)	1.00 (25.4)	3.00 (76.2)	1.00 (25.4)	0.07 (1.8)	
3 x 4 (76.2) (101.6)	3.14 (79.8)	4.06 (103.1)	3.25 (82.6)	3.63 (92.2)	0.31 (7.9)	1.00 (25.4)	4.00 (101.6)	1.00 (25.4)	0.08 (2.0)	
3 x 5 (76.2) (127.0)	3.14 (79.8)	5.06 (128.5)	3.25 (82.6)	4.63 (117.6)	0.38 (9.7)	1.33 (33.8)	5.00 (127.0)	1.00 (25.4)	0.09 (2.3)	
4 x 2 (101.6) (50.8)	4.14 (105.2)	2.06 (52.3)	4.25 (108.0)	1.63 (41.4)	0.31 (7.9)	0.80 (20.3)	2.00 (50.8)	1.50 (38.1)	0.07 (1.8)	
4 x 3 (101.6) (76.2)	4.14 (105.2)	3.06 (77.7)	4.25 (108.0)	2.63 (66.8)	0.31 (7.9)	1.00 (25.4)	3.00 (76.2)	1.50 (38.1)	0.07 (1.8)	
4 x 4 (101.6) (101.6)	4.14 (105.2)	4.06 (103.1)	4.25 (108.0)	3.63 (92.2)	0.31 (7.9)	1.00 (25.4)	4.00 (101.6)	1.50 (38.1)	0.08 (2.0)	
4 x 5 (101.6) (127.0)	4.14 (105.2)	5.06 (128.5)	4.25 (108.0)	4.63 (117.6)	0.38 (9.7)	1.33 (33.8)	5.00 (127.0)	1.50 (38.1)	0.09 (2.3)	

## PANDUCT® Type H Wiring Duct Dimensions

Dimensions are shown for reference only. Contact customer service (see page footnote) for specific dimensional needs.

DUCT SIZE (W x H)	DIMENSIONS-Inches (mm)								
	A	B	C	D	E	F	H	K	T
1.5 x 2 (38.1) x (50.8)	1.75 (44.5)	1.98 (50.3)	1.88 (47.8)	1.63 (41.4)	0.31 (7.9)	0.80 (20.3)	1.92 (48.8)	1.00	0.08 (2.0)
1.5 x 3 (38.1) x (76.2)	1.75 (44.5)	3.06 (77.7)	1.88 (47.8)	2.63 (66.8)	0.31 (7.9)	1.00 (25.4)	3.00 (76.2)		0.10 (2.5)
2 x 2 (50.8) x (50.8)	2.17 (55.1)	1.98 (50.3)	2.29 (58.2)	1.57 (39.9)	0.31 (7.9)	0.80 (20.3)	1.92 (48.8)	0.50 (12.7)	0.08 (2.0)
2 x 3 (50.8) x (76.2)	2.17 (55.1)	3.06 (77.7)	2.29 (58.2)	2.63 (66.8)	0.31 (7.9)	0.50 (12.7)	3.00 (76.2)	0.50 (12.7)	0.10 (2.5)
2 x 4 (50.8) x (101.6)	2.17 (55.1)	4.1 (104.1)	4.38 (111.3)	3.63 (92.2)	0.31 (7.9)	1.00 (25.4)	4.00 (101.6)	0.50 (12.7)	0.10 (2.7)
3 x 3 (76.2) x (76.2)	3.25 (82.6)	3.06 (77.7)	3.38 (85.9)	2.63 (66.8)	0.31 (7.9)	1.00 (25.4)	3.00 (76.2)	1.00 (25.4)	0.10 (2.5)
3 x 4 (76.2) x (101.6)	3.25 (82.6)	4.1 (104.1)	3.38 (85.9)	3.63 (92.2)	0.31 (7.9)	1.00 (25.4)	4.00 (101.6)	1.00 (25.4)	0.11 (2.8)
4 x 4 (101.6) x (101.6)	4.25 (108.0)	4.1 (104.1)	4.38 (111.3)	3.63 (92.2)	0.31 (7.9)	1.00 (25.4)	4.00 (101.6)	1.50 (38.1)	0.11 (2.8)

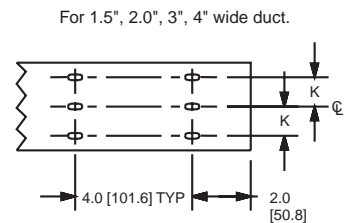
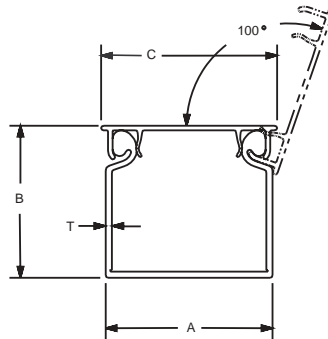
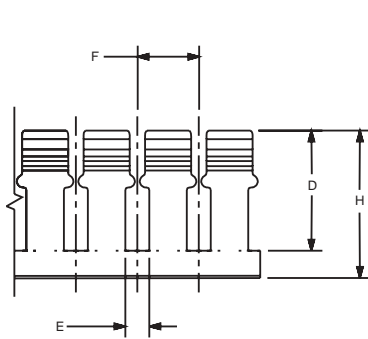

## PANDUCT® Type FL Wiring Duct Dimensions

Dimensions are shown for reference only. Dimensions are in mm (in.). Contact customer service (see page footnote) for specific dimensional needs.

DUCT SIZE (W x H)	DIMENSIONS-mm (Inches)	
	A	B
12 x 12 (0.47) x (0.47)	12.5 (0.49)	12.5 (0.49)
25 x 25 (0.98) x (0.98)	25.0 (0.98)	25.0 (0.98)
50 x 50 (1.97) x (1.97)	50.0 (1.97)	50.0 (1.97)

Note: Type FL Duct has factory applied adhesive. For 50 x 50 two strips of tape are used; otherwise, only one strip is centered on the part.

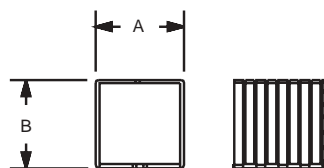
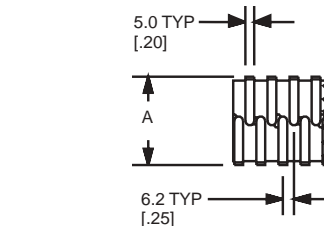

Note: 'B' dimension is without adhesive.

### Mounting Hole Dimensions For FL12X12LG-A

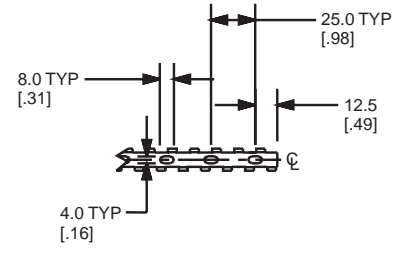

### For FL25X25LG-A & FL50X50LG-A

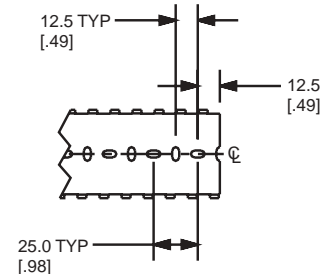

# Wiring Duct *Technical Info*

## PANDUCT® Type D, G, F & FS Wiring Duct — Wirefill Capacity

NOMINAL DUCT SIZE (W x H) inches	NOMINAL AREA in <sup>2</sup>	ELECTRICAL											COMMUNICATION						
		8 AWG		10 AWG		12 AWG		14 AWG			16 AWG		18 AWG		22 AWG		24 AWG		
		.216	.153	.122	.158	.105	.139	.165	.096	.125	.084	.113	.065	.217	.250	.422	UTP/CM CAT 5e	STP/CM CAT 6	UTP/CM
		THHN	THHN	THHN	MTW	THHN	MTW	MTW	TFFN	MTW	TFFN	MTW	MTW	UTP/CM CAT 5e	STP/CM CAT 6	UTP/CM			
.5 x .5	.250	3	6	10	6	13	7	5	16	9	20	11	34	3	2	1			
.5 x 1	.500	6	12	19	11	26	15	10	31	18	40	22	68	6	5	2			
.5 x 2	1.000	12	24	38	23	52	30	21	62	37	81	45	135	12	9	3			
.75 x .75	.563	7	14	22	13	29	17	12	35	21	46	25	76	7	5	2			
.75 x 1	.750	9	18	29	17	39	22	16	47	27	61	34	101	9	7	2			
.75 x 1.5	1.125	14	27	43	26	58	33	24	70	41	91	50	152	14	10	4			
.75 x 2	1.500	18	37	58	34	78	44	31	93	55	121	67	203	18	14	5			
1 x 1	1.000	12	24	38	23	52	30	21	62	37	81	45	135	12	9	3			
1 x 1.5	1.500	18	37	58	34	78	44	31	93	55	121	67	203	18	14	5			
1 x 2	2.000	24	49	77	46	104	59	42	124	73	162	90	270	24	18	6			
1 x 3	3.000	37	73	115	69	155	89	63	186	110	243	134	406	36	27	10			
1 x 4	4.000	49	98	154	92	207	118	84	248	146	324	179	541	49	37	13			
1.5 x 1	1.500	18	37	58	34	78	44	31	93	55	121	67	203	18	14	5			
1.5 x 1.5	2.250	28	55	86	52	117	67	47	140	82	182	101	304	27	21	7			
1.5 x 2	3.000	37	73	115	69	155	89	63	186	110	243	134	406	36	27	10			
1.5 x 3	4.500	55	110	173	103	233	133	94	279	165	364	201	609	55	41	14			
1.5 x 4	6.000	73	146	230	137	311	177	126	372	219	486	269	811	73	55	19			
2 x 1	2.000	24	49	77	46	104	59	42	124	73	162	90	270	24	18	6			
2 x 1.5	3.000	37	73	115	69	155	89	63	186	110	243	134	406	36	27	10			
2 x 2	4.000	49	98	154	92	207	118	84	248	146	324	179	541	49	37	13			
2 x 3	6.000	73	146	230	137	311	177	126	372	219	486	269	811	73	55	19			
2 x 4	8.000	98	195	307	183	415	237	168	496	293	648	358	1082	97	73	26			
2 x 5	10.000	122	244	384	229	518	296	210	620	366	810	448	1352	121	91	32			
2.5 x 3	7.500	92	183	288	172	389	222	157	465	274	607	336	1014	91	69	24			
3 x 1	3.000	37	73	115	69	155	89	63	186	110	243	134	406	36	27	10			
3 x 2	6.000	73	146	230	137	311	177	126	372	219	486	269	811	73	55	19			
3 x 3	9.000	110	220	346	206	466	266	189	558	329	729	403	1217	109	82	29			
3 x 4	12.000	147	293	461	275	622	355	252	744	439	972	537	1623	146	110	39			
3 x 5	15.000	184	366	576	343	777	444	315	930	549	1215	671	2029	182	137	48			
4 x 1.5	6.000	73	146	230	137	311	177	126	372	319	486	269	811	73	55	19			
4 x 2	8.000	98	195	307	183	415	237	168	496	293	648	358	1082	97	73	26			
4 x 3	12.000	147	293	461	275	622	355	252	744	439	972	537	1623	146	110	39			
4 x 4	16.000	196	391	614	366	829	473	336	992	585	1296	716	2164	194	146	51			
4 x 5	20.000	245	488	768	458	1037	592	420	1240	731	1620	895	2705	243	183	64			
6 x 4	24.000	294	586	921	549	1244	710	504	1488	878	1944	1074	3246	291	219	77			

Not all sizes available for each duct type.  
See **page F14** for wiring duct color and size availability.  
Wirefill is based on 50% cross-sectional area.

**Formula used to calculate fill capacity:**

$$\text{Number of Wires} = \frac{\text{Duct W x H}}{1.75 \times (\text{Wire O.D.})^2}$$

See **page F11** for explanation of wirefill formula.

### Formula to approximate wiring duct size needed:

#### Wire O.D. for multiple wire types:

$$\text{Wire O.D.} = \frac{\sum (\text{Number of Wires} \times \text{Wire O.D.})}{\text{Number of Wires}}$$

Example:  
15 wires with .165" O.D. = 15 x .165 = 2.475  
28 wires with .065" O.D. = 28 x .065 = 1.820  
16 wires with .125" O.D. = 16 x .125 = 2.000  
**59 total wires = 6.295**

$$6.295 \div 59 = \text{Wire O.D.} = \boxed{.107}$$

1. Determine the **number of wires** the duct will need to contain.
2. Determine the **wire outside diameter** (for multiple wires see formula at left).
3. Calculate the necessary **wire area** using the following formula:

$$\text{Wire Area} = \text{Number of Wires} \times [1.75 \times (\text{Wire O.D.})^2]$$

Example: Wire Area = 59 x [1.75 x (.107)<sup>2</sup>] = 59 x .020 = **1.182**

4. **Choose a Duct** with W x H equal to or greater than the result from step 3.

$$\text{Area of Selected Duct} \geq \text{Calculated Wire Area}$$

Example: For Duct Size .75" x 1.5" Duct Area = .75 x 1.5 = 1.125 sq. in.  
(No good 1.125 < 1.182)  
For Duct Size 1.5" x 1" Duct Area = 1.5 x 1 = 1.1500 sq. in.  
(Good 1.500 > 1.182)

In the above example 1" x 1.5" duct or larger could also be used.



## PANDUCT® Type MC, NNC & TMC Wiring Duct — Wirefill Capacity

NOMINAL DUCT SIZE (W x H) mm.	NOMINAL AREA mm <sup>2</sup>	ELECTRICAL											COMMUNICATION					
		8 AWG		10 AWG		12 AWG		14 AWG			16 AWG		18 AWG		22 AWG	24 AWG		
		.216	.153	.122	.158	.105	.139	.165	.096	.125	.084	.113	.065	.217	.250	.422		
		THHN	THHN	THHN	MTW	THHN	MTW	MTW	THHN	MTW	THHN	MTW	MTW	UTP/CM CAT 5e	STP/CM CAT 6	UTP/CM		
25 x 25	625	12	24	37	22	50	29	20	60	35	78	43	131	12	9	3		
25 x 37	925	18	35	55	33	74	42	30	89	52	116	64	194	17	13	5		
25 x 50	1250	24	47	74	44	100	57	41	120	71	157	87	262	24	18	6		
25 x 62	1550	29	59	92	55	125	71	50	149	88	195	108	325	29	22	8		
25 x 75	1875	36	71	112	67	151	86	61	180	106	235	130	393	35	27	9		
37 x 37	1369	26	52	81	49	110	63	45	132	78	172	95	287	26	19	7		
37 x 50	1850	35	70	110	66	149	85	60	178	105	232	128	388	35	26	9		
37 x 62	2294	44	87	136	81	184	105	75	220	130	288	159	481	43	33	11		
37 x 75	2775	53	105	165	98	223	127	90	267	157	348	193	582	52	39	14		
50 x 50	2500	47	95	149	89	201	115	81	240	142	314	173	524	47	35	12		
50 x 75	3750	71	142	223	133	301	172	122	360	213	471	260	786	71	53	19		
50 x 100	5000	95	189	298	177	402	229	163	481	283	628	347	1048	94	71	25		
62 x 37	2294	44	87	136	81	184	105	75	220	130	288	159	481	43	33	11		
62 x 62	3844	73	145	229	136	309	176	125	369	218	483	267	806	72	54	19		
75 x 50	3750	71	142	223	133	301	172	122	360	213	471	260	786	71	53	19		
75 x 62	4650	88	176	277	165	374	213	151	447	264	584	323	975	87	66	23		
75 x 75	5625	107	213	335	200	452	258	183	541	319	706	390	1179	106	80	28		
75 x 100	7500	142	284	446	266	603	344	244	721	425	941	520	1572	141	106	37		
100 x 50	5000	95	189	298	177	402	229	163	481	283	628	347	1048	94	71	25		
100 x 62	6200	118	235	369	220	498	284	202	596	351	778	430	1300	117	88	31		
100 x 75	7500	142	284	446	266	603	344	244	721	425	941	520	1572	141	106	37		
100 x 100	10000	190	378	595	355	803	458	325	961	567	1255	694	2096	188	142	50		

Not all sizes available for each duct type.  
See page F14 for wiring duct color and size availability.  
Wirefill is based on 50% cross-sectional area.

## PANDUCT® Type H Wiring Duct — Wirefill Capacity

NOMINAL DUCT SIZE (W X H) inches	NOMINAL AREA in <sup>2</sup>	ELECTRICAL											NETWORK CABLES					
		8 AWG		10 AWG		12 AWG		14 AWG			16 AWG		18 AWG		22 AWG	24 AWG		
		.216	.153	.122	.158	.105	.139	.165	.096	.125	.084	.113	.065	.217	.250	.422		
		THHN	THHN	THHN	MTW	THHN	MTW	MTW	THHN	MTW	THHN	MTW	MTW	UTP/CM CAT 5e	UTP/CM CAT 6	UTP/CM		
1.5 X 2	3.000	34	69	108	64	147	83	59	175	103	229	126	383	34	25	9		
1.5 X 3	4.500	52	103	163	97	220	125	89	263	155	344	190	575	51	38	13		
2 X 2	4.000	46	92	145	86	196	111	79	234	138	306	169	511	45	34	12		
2 X 3	6.000	69	138	217	129	294	167	119	351	207	459	253	767	68	51	18		
2 X 4	8.000	92	184	290	173	392	223	158	469	276	612	338	1023	91	69	24		
3 X 3	9.000	104	207	326	194	441	251	178	527	311	689	380	1151	103	77	27		
3 X 4	12.000	139	277	435	259	588	335	238	703	415	919	507	1535	137	103	36		
4 X 4	16.000	185	369	581	346	784	447	317	938	553	1225	677	2047	183	138	48		

Wirefill is based on 50% cross-sectional area.

## PANDUCT® Type FL Wiring Duct — Wirefill Capacity

NOMINAL DUCT SIZE (W x H) mm	NOMINAL AREA mm <sup>2</sup>	ELECTRICAL	
		10 AWG	12 AWG
		.153	.122
		THHN	THHN
12 x 12	144	3	5
25 x 25	625	12	19
50 x 50	2500	43	67

Wirefill is based on 50% cross-sectional area.

Control Panel

Special Environment

Data &amp; Voice

Tools &amp; Accessories

Technical Info

Index

# Wiring Duct *Technical Info*

## PANDUCT® Type NE Wiring Duct — Wirefill Capacity

Control Panel

Special Environment

Data & Voice

Tools & Accessories

Technical Info

Index

NOMINAL DUCT SIZE (W x H) inches	NOMINAL AREA in <sup>2</sup>	ELECTRICAL											COMMUNICATION						
		8 AWG		10 AWG		12 AWG		14 AWG			16 AWG		18 AWG		22 AWG		24 AWG		
		.216	.153	.122	.158	.105	.139	.165	.096	.125	.084	.113	.065	.217	.250	.422			
		THHN	THHN	THHN	MTW	THHN	MTW	MTW	TFFN	MTW	TFFN	MTW	MTW	UTP/CM CAT 5e	STP/CM CAT 6	UTP/CM			
.5 x .5	.250	3	5	8	5	11	6	5	14	8	18	10	30	3	2	1			
.5 x 1	.500	5	11	17	10	23	13	9	27	16	35	20	59	5	4	1			
1 x 1	1.000	11	21	34	20	45	26	18	54	32	71	39	118	11	8	3			
1 x 1.5	1.500	16	32	50	30	68	39	28	81	48	106	59	178	16	12	4			
1 x 2	2.000	21	43	67	40	91	52	37	109	64	142	78	237	21	16	6			
1 x 3	3.000	32	64	101	60	136	78	55	163	96	213	117	355	32	24	8			
1 x 4	4.000	43	85	134	80	181	104	73	217	128	283	157	473	42	32	11			
1.5 x 1.5	2.250	24	48	76	45	102	58	41	122	72	159	88	266	24	18	6			
1.5 x 2	3.000	32	64	101	60	136	78	55	163	96	213	117	355	32	24	8			
1.5 x 3	4.500	48	96	151	90	204	116	83	244	144	319	176	533	48	36	13			
1.5 x 4	6.000	64	128	202	120	272	155	110	326	192	425	235	710	64	48	17			
2 x 1	2.000	21	43	67	40	91	52	37	109	64	142	78	237	21	16	6			
2 x 2	4.000	43	85	134	80	181	104	73	217	128	283	157	473	42	32	11			
2 x 3	6.000	64	128	202	120	272	155	110	326	192	425	235	710	64	48	17			
2 x 4	8.000	86	171	269	160	363	207	147	434	256	567	313	947	85	64	22			
2.5 x 3	7.500	80	160	252	150	340	194	138	407	240	531	294	888	80	60	21			
3 x 1	3.000	32	64	101	60	136	78	55	163	96	213	117	355	32	24	8			
3 x 2	6.000	64	128	202	120	272	155	110	326	192	425	235	710	64	48	17			
3 x 3	9.000	96	192	302	180	408	233	165	488	288	638	352	1065	96	72	25			
3 x 4	12.000	129	256	403	240	544	311	220	651	384	850	470	1420	127	96	34			
3 x 5	15.000	161	320	504	300	680	388	275	814	480	1063	587	1775	159	120	42			
4 x 2	8.000	86	171	269	160	363	207	147	434	256	567	313	947	85	64	22			
4 x 3	12.000	129	256	403	240	544	311	220	651	384	850	470	1420	127	96	34			
4 x 4	16.000	171	342	537	320	726	414	294	868	512	1134	627	1893	170	128	45			
4 x 5	20.000	214	427	672	401	907	518	367	1085	640	1417	783	2367	212	160	56			

Wirefill is based on 50% cross-sectional area.

**Formula used to calculate fill capacity:** Number of Wires =  $\frac{\text{Duct W x H}}{2.00 \times (\text{Wire O.D.})^2}$

See [page F11](#) for explanation of wirefill formula.

### Formula to approximate wiring duct size needed:

#### Wire O.D. for multiple wire types:

$$\text{Wire O.D.} = \frac{\sum (\text{Number of Wires} \times \text{Wire O.D.})}{\text{Number of Wires}}$$

Example:

15 wires with .165" O.D. = 15 x .165 = 2.475  
 28 wires with .065" O.D. = 28 x .065 = 1.820  
 16 wires with .125" O.D. = 16 x .125 = 2.000  
**59 total wires = 6.295**

6.295 ÷ 59 = Wire O.D. = .107

1. Determine the **number of wires** the duct will need to contain.
2. Determine the **wire outside diameter** (for multiple wires see formula at left).
3. Calculate the necessary **wire area** using the following formula:

$$\text{Wire Area} = \text{Number of Wires} \times [2 \times (\text{Wire O.D.})^2]$$

Example:  $\text{Wire Area} = 59 \times [2 \times (.107)^2] = 59 \times .020 = 1.357$

4. **Choose a Duct** with W x H equal to or greater than the result from step 3.

$$\text{Area of Selected Duct} \geq \text{Calculated Wire Area}$$

Example: For Duct Size .75" x 1.5" Duct Area = .75 x 1.5 = 1.125 sq. in.  
 (No good 1.125 < 1.1357)  
 For Duct Size 1.5" x 1" Duct Area = 1.5 x 1 = 1.1500 sq. in.  
 (Good 1.500 > 1.357)

In the above example 1" x 1.5" duct or larger could also be used.

## Wirefill Formula (Flush cover duct Types G, F, FS, D, H, MC, NNC, & TMC)

### General Formula

PANDUIT® Wiring Duct wirefills are calculated using the following general formula:

$$50\% \text{ Wirefill} = 50\% \text{ of } \left( \frac{\text{Usable Duct Area}}{\text{Wire Area}} \right)$$

### Why use a 50% Wirefill?

As specified in NFPA79-2002 section 14.5.2, *Percentage Fills of Raceways (Ducts)*, a 50% wirefill is given as the maximum wirefill capacity in all PANDUIT® Wiring Ducts. This helps ensure general safe wiring practices are followed. In actual practice, a 50% wirefill is the maximum amount of wiring the duct can hold given the additional airspace created between cables by non-uniform cable shapes, cable interlacing and cable packing factors.

### What is the Usable Duct Area?

The usable area we define as the calculation of internal area that can be occupied by wires or cables.

#### Calculation of Internal Area

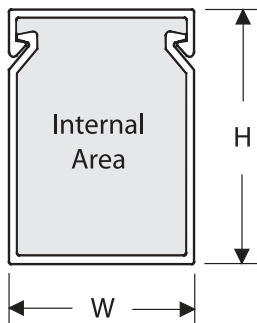

Since we use the outer channel dimensions in our calculation we make an adjustment in our formula for the thickness of material and for design elements that extend inside the channel.

#### Air Space Allotment

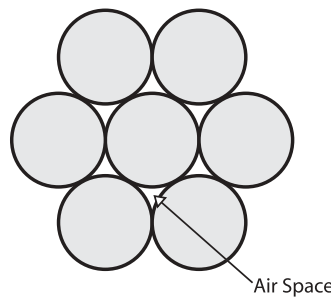

In our wirefill formula an adjustment is made to the channel internal area to account for “unusable” air space that will be present between cables when placed in the channel. Our formula assumes a uniform close packed or high-density cable arrangement (see diagram).<sup>1</sup>

Considering these factors the usable duct area is equal to an average of 90% of the nominal area, or  $(W \times H) \times .90$ .

### Wire Area

The wire area formula is converted to allow calculation using the cable diameter:

$$\begin{aligned} A_{\text{WIRE}} &= \pi r^2 \\ A_{\text{WIRE}} &= (\pi/4) \times D^2 \\ A_{\text{WIRE}} &= .785 \times D^2 \end{aligned}$$

### Formula Derivation

Inserting the elements from above into the general formula results in the following:

$$50\% \text{ Wirefill} = .50 \left( \frac{(W \times H) \times 0.90}{.785 \times D^2} \right)$$

Simplifying this formula results in the formula used for wire fill calculation<sup>2</sup>:

$$50\% \text{ Wirefill} = \left( \frac{W \times H}{1.75 \times D^2} \right)$$

NOTE: When calculating wirefill capacity using the above formula, variables W, H, and D must be expressed in same units (i.e. mm or inches).

<sup>1</sup> This calculation does not account for additional airspace created between cables by non-uniform cable shapes, cable interlacing and cable packing factors.

<sup>2</sup> The resulting formula is used for all PANDUIT® Flush Cover Ducts, this excludes Type NE duct which has a different profile design that results in a divisor of  $2.0 \times D^2$  (rather than  $1.75 \times D^2$  as shown here) to be used in the wirefill calculation formula.

# Wiring Duct *Technical Info*

## **PANDUCT® Wiring Duct and Raceway — UL94 Vertical Burn Test\***

### **Flammability**

This test method measures the comparative burning characteristics of solid plastic materials.

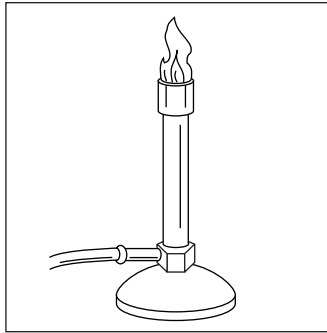

### **UL Vertical Burning Test**

Test samples measure 125mm by the 13mm by the minimum thickness of the end product. Tests are conducted utilizing unaged samples (as manufactured) and aged samples (7 days @70°C/158°F). A standard test flame is applied for two 10 second applications to the unsupported end of avertically clamped sample. The after-flame is recorded following the first flame application. Both after-flame and afterglow times are recorded following the second flame application. Also observed and documented are, if the sample drips flaming particles that ignite the cotton layer below.

### **Materials Classed V-0 Shall:**

- After flame for each sample does not exceed 10 seconds following the removal of each flame application
- Total afterflame time for a set of five samples following both flame application is not greater than 50 seconds
- Afterflame plus afterglow time for each sample does not exceed 30 seconds following the second flame application
- The sample does not exhibit afterflame or afterglow up to the holding clamp
- The cotton indicator below the sample does not ignite from flaming particles or droplets from the test sample

### **Materials Classed V-1 Shall:**

- Not have any specimens which burn with flaming combustion for more than 30 seconds after either application of the test flame
- Not have a total flaming combustion time exceeding 250 seconds for each set of five specimens
- Not have any specimens with glowing combustion, which persists for more than 60 seconds after the second removal of the test flame
- Not have any specimens which burn with flaming or glowing combustion up to the holding clamp
- Not have any specimens which drip flaming particles that ignite the cotton indicator below the test specimen

### **Materials Classed V-2 Shall:**

- Not have any specimens which burn with flaming combustion for more than 30 seconds after either application of the test flame
- Not have a total flaming combustion time exceeding 250 seconds each set of five specimens
- Not have any specimens with glowing combustion which persists for more than 60 seconds after the second removal of the test flame
- Not have any specimens which burn with flaming or glowing combustion up to the holding clamp
- Be permitted to have specimens which drip flaming particles which ignite the cotton indicator below the test specimen

\* The flammability rating determined from this method does not indicate its performance in end-user applications.

# Wiring Duct *Technical Info*

## PANDUCT® Wiring Duct and Raceway — Color and Size Selection

Control Panel

Special Environment

Voice & Data

Tools & Accessories

Technical Info

Index

Duct Size W x H (inches)	LG Light Gray					WH White					DG Dark Gray	BL Black	IB Intrinsic Blue*	BR Beige	IG International Gray							
	G	F	FS			G	F	FS	NE													
.5 x .5	G	F	FS			G	F	FS	NE													
.5 x 1	G	F	FS			G	F	FS	NE													
.5 x 2	G					G																
.5 x 4	G					G																
.75 x .75	G	F	FS			G	F	FS														
.75 x 1	G					G																
.75 x 1.5	G	F				G	F															
.75 x 2	G					G																
1 x 1	G	F	FS		NNC25X25mm	G	F	FS	NE	NNC25X25mm	G	G		G	MC25X25mm							
1 x 1.5	G	F	FS		NNC25X37mm	G	F		NE	NNC25X37mm	G	G		TMC25X37mm	MC25X37mm							
1 x 2	G	F		D	NNC25X50mm	G	F		NE	NNC25X50mm	G	G	D	G	MC25X50mm							
1 x 2.5															MC25X62mm							
1 x 3	G	F	FS	D	NNC25X75mm	G	F	D	NE	NNC25X75mm	G	G	D		MC25X75mm							
1 x 4	G	F		D		G		D	NE			G	D									
1.5 x 1	G	F	FS			G	F	FS														
1.5 x 1.5	G	F	FS		NNC37X37mm	G	F	FS	NE	NNC37X37mm		G		TMC37X37mm	MC37X37mm							
1.5 x 2	G	F	FS	D	H	NNC37X50mm	G	F		NE	H	NNC37X50mm	G	G	D	H	MC37X50mm					
1.5 x 2.5															MC37X62mm							
1.5 x 3	G	F	FS	D	H	NNC37X75mm	G	F	D	NE	H	NNC37X75mm	G	G	D	H	MC37X75mm					
1.5 x 4	G	F		D		G	F		D	NE		G	G	D								
2 x 1	G	F	FS			G	F	FS	NE			G	G									
2 x 1.5	G	F	FS			G	F	FS				G										
2 x 2	G	F	FS	D	H	NNC50X50mm	G	F	FS	D	NE	H	NNC50X50mm	G	FS	G	FS	D	H	G	TMC50X50mm	MC50X50mm
2 x 3	G	F	FS	D	H	NNC50X75mm	G	F	FS	D	NE	H	NNC50X75mm	G	G	D	H	G			MC50X75mm	
2 x 4	G	F		D	H	NNC50X100mm	G	F		D	NE	H	NNC50X100mm	G	G	D	H				MC50X100mm	
2 x 5	G	F				G						G										
2.5 x 1.5																					MC62X37mm	
2.5 x 2.5																					MC62X62mm	
2.5 x 3	G			D		G			NE				G									
3 x 1	G	F	FS			G	F	FS	NE													
3 x 2	G	F	FS	D		G	F	FS	NE			G	G	FS							TMC75X50mm	MC75X50mm
3 x 2.5																					MC75X62mm	
3 x 3	G	F	FS	D	H	NNC75X75mm	G	F	FS	D	NE	H	NNC75X5mm	G	FS	G	FS	D	H	G	TMC75X75mm	MC75X75mm
3 x 4	G	F	FS	D	H		G	F	FS	D	NE	H		G	G	D	H	G			MC75X100mm	
3 x 5	G	F	FS			G	F	FS	NE			G										
4 x 1.5	G		FS			G						G	G									
4 x 2	G	F	FS	D		NNC100X50mm	G	F	FS	NE		NNC100X50mm		G		D					TMC100X50mm	MC100X50mm
4 x 2.5																					MC100X62mm	
4 x 3	G	F	FS	D		NNC100X75mm	G	F	FS	NE		NNC100X75mm	G	G							TMC100X75mm	MC100X75mm
4 x 4	G	F	FS	D	H	NNC100X100mm	G	F	FS	D	NE	H	NNC100X100mm	G	FS	G	FS	D	H	G		MC100X100mm
4 x 5	G	F	FS			G	F		NE			G	G									
6 x 4	G		FS			G						G										

### \*Intrinsic Blue Color — IB

Intrinsic Blue wiring duct is made from the same PVC material as our standard PVC duct. Intrinsic Blue is an internationally recognized standard blue color that identifies the wiring duct as “incapable of releasing sufficient electrical or thermal energy under normal or abnormal conditions to cause ignition of a specific hazardous atmospheric mixture in its most easily ignited concentrations.”

\*ISA-RD12.6 (Instrument Society of America)

# Wiring Duct *Technical Info*

## PANDUCT® Wiring Duct and Raceway — Color and Size Selection

Duct Size W x H (inches)	LG Light Gray						WH White						DG Dark Gray	BL Black	IB Intrinsic Blue*	BR Beige	IG International Gray			
	G	F	FS				G	F	FS			NE								
.5 x .5	G	F	FS				G	F	FS			NE								
.5 x 1	G	F	FS				G	F	FS			NE								
.5 x 2	G						G													
.5 x 4	G						G													
.75 x .75	G	F	FS				G	F	FS											
.75 x 1	G						G													
.75 x 1.5	G	F					G	F												
.75 x 2	G						G						G							
1 x 1	G	F	FS			NNC25X25mm	G	F	FS		NE	NNC25X25mm	G	G		G	MC25X25mm			
1 x 1.5	G	F	FS			NNC25X37mm	G	F	FS		NE	NNC25X37mm	G	G		TMC25X37mm	MC25X37mm			
1 x 2	G	F		D		NNC25X50mm	G	F		D	NE	NNC25X50mm	G	G	D	G	MC25X50mm			
1 x 2.5																	MC25X62mm			
1 x 3	G	F	FS	D		NNC25X75mm	G	F	FS	D	NE	NNC25X75mm	G	G	D		MC25X75mm			
1 x 4	G	F		D			G			D	NE		G	D						
1.5 x 1	G	F	FS				G	F	FS											
1.5 x 1.5	G	F	FS			NNC37X37mm	G	F	FS		NE	NNC37X37mm		G		TMC37X37mm	MC37X37mm			
1.5 x 2	G	F	FS	D	H	NNC37X50mm	G	F	FS	D	H	NNC37X50mm	G	G	D	H	MC37X50mm			
1.5 x 2.5																	MC37X62mm			
1.5 x 3	G	F	FS	D	H	NNC37X75mm	G	F	FS	D	NE	NNC37X75mm	G	G	D	H	MC37X75mm			
1.5 x 4	G	F		D			G	F		D	NE		G	G	D					
2 x 1	G	F	FS				G	F	FS		NE			G						
2 x 1.5	G	F	FS				G	F	FS				G							
2 x 2	G	F	FS	D	H	NNC50X50mm	G	F	FS	D	NE	H	NNC50X50mm	G	FS	D	H	G	TMC50X50mm	MC50X50mm
2 x 3	G	F	FS	D	H	NNC50X75mm	G	F	FS	D	NE	H	NNC50X75mm	G	G	D	H	G		MC50X75mm
2 x 4	G	F		D	H	NNC50X100mm	G	F		D	NE	H	NNC50X100mm	G	G	D	H			MC50X100mm
2 x 5	G	F					G						G							
2.5 x 1.5																				MC62X37mm
2.5 x 2.5																				MC62X62mm
2.5 x 3	G			D			G				NE			G						
3 x 1	G	F	FS				G	F	FS		NE									
3 x 2	G	F	FS	D			G	F	FS	D	NE		G	G	FS				TMC75X50mm	MC75X50mm
3 x 2.5																				MC75X62mm
3 x 3	G	F	FS	D	H	NNC75X75mm	G	F	FS	D	NE	H	NNC75X75mm	G	FS	D	H	G	TMC75X75mm	MC75X75mm
3 x 4	G	F	FS	D	H		G	F	FS	D	NE	H		G	G	D	H			MC75X100mm
3 x 5	G	F	FS				G	F	FS		NE			G						
4 x 1.5	G		FS				G						G	G						
4 x 2	G	F	FS	D		NNC100X50mm	G	F	FS	D	NE	NNC100X50mm		G	D			TMC100X50mm	MC100X50mm	
4 x 2.5																				MC100X62mm
4 x 3	G	F	FS	D		NNC100X75mm	G	F	FS	D	NE	NNC100X75mm	G	G				TMC100X75mm	MC100X75mm	
4 x 4	G	F	FS	D	H	NNC100X100mm	G	F	FS	D	NE	H	NNC100X100mm	G	FS	D	H	G		MC100X100mm
4 x 5	G	F	FS				G	F	FS		NE			G	G					
6 x 4	G		FS				G						G							

### \*Intrinsic Blue Color — IB

Intrinsic Blue wiring duct is made from the same PVC material as our standard PVC duct. Intrinsic Blue is an internationally recognized standard blue color that identifies the wiring duct as “incapable of releasing sufficient electrical or thermal energy under normal or abnormal conditions to cause ignition of a specific hazardous atmospheric mixture in its most easily ignited concentrations.”

\*ISA-RD12.6 (Instrument Society of America)

## Installation Tips:

### Application of Latex Paint on PANDUCT® Wiring Duct



The following is recommended to properly prepare the surface of the wiring duct/raceway and covers for the best adhesion of latex paint:

1. Clean surface with mild soap and water solution or mineral spirits with a clean lint free towel. Allow to dry.
2. Using a sanding pad (such as synthetic stripping pad or medium/fine steel wool), slightly roughen the surface to be painted.
3. Apply a coat of all-purpose 100% Acrylic primer and allow to dry.
4. Apply the desired topcoat of latex paint and allow to dry.
5. Install the wiring duct/raceway and covers.

### Cutting Wiring Duct and Cover

For small quantities, use the DCT Duct Cutting Tool on [page E14](#). For larger quantities use a miter cutting saw blade for clean burr-free cuts. Recommended Blade: Carbide 80T or 100T; .90" thickness, .125 kerf.

### Recommended Precaution when Using Type NNC and NE Wiring Duct

Cleaning solvents and cutting fluids that contain any of the following chemical agents should not come in contact with Type NNC or Type NE wiring duct. These chemicals are known to cause stress cracking in the halogen free PPO material.

- Hydrocarbons
- Phenols
- Ketones
- Amines
- Ethers
- Organic, Inorganic and Oxidizing Acids
- Petrol

Note: PANDUIT® assumes no liability for the accuracy or completeness of this list.

## Assured Quality

To assure optimum quality, PANDUIT® products are designed and manufactured to meet applicable international, UL and customer standards:



The International Standards Organization (ISO) establishes worldwide standards for products and services in recognition of increasing globalization of markets. ISO program sets up the requirements for quality assurance systems of these worldwide standards. PANDUIT® is registered to ISO 9001, the most comprehensive model in the standard, meant for companies who design, manufacture, install and service the products they sell. Registration has been awarded by Underwriters Laboratories (Certificate No. A2269) after extensive audit of QA systems employed at PANDUIT®.



ISO 14001 is a voluntary standard for Environmental Management Systems established by the International Standards Organization. The international standard provides a benchmark for continual improvement in environmental performance. Business partners can be confident that PANDUIT® manufacturing facilities around the globe are engaged in an on-going process to maximize value while minimizing impact on global natural resources.

# Wiring Duct *Technical Info*

## Agency Approvals



File No. E147128

All *PANDUIT*® wiring duct is recognized by Underwriters Laboratory as meeting the requirements set forth in UL Standard 1565 “Positioning Devices.” Underwriters Laboratory is an independent, not-for-profit organization that investigates, tests and certifies thousands of products and materials for electrical safety.



File No. 016446, 210335

The Canadian Standards Association as meeting the applicable requirements in CSA Standard C22.2 No. 18.5 certifies all *PANDUIT*® wiring duct. The Canadian Standard Association is a not-for-profit association serving business, industry, government and consumers in Canada and the global marketplace.



Most *PANDUIT*® wiring duct carries the CE (Conformite European) Marking indicating it meets the essential requirements of all relevant European Directives.

## Standards

### ***PANDUIT*® Wiring Duct Compliant with National Fire Protection Agency 79-2002**

*PANDUIT*® has completed material testing with compliant results per IEC 60332-1 test method (Tests on Electric Cables Under Fire Conditions). Results show *PANDUIT*® wiring ducts are manufactured with flame-retardant materials (as defined). This testing was required in order to comply with stricter requirements included in the NFPA-79-2002 Electrical Standard for Industrial Machinery. Section 14.3.1 in the standard states that “Nonmetallic ducts shall be permitted [inside enclosures] only when they are made with a flame-retardant material.” Flame-retardant material is defined in the standard by the IEC 60332-1 test method.

As specified in NFPA79-2002 section 14.5.1.4, *PANDUIT*® Wiring Duct publishes a maximum percentage wire fill for common wire types equal to 50 percent of the interior cross-sectional area of the duct.

*PANDUIT*® bend radius control accessories can be mounted at right angle and tee junctions created using wiring duct in order to maintain cable bend radius control as is specified in NFPA79-2002 section 14.1.4.9.

### ***PANDUIT*® PVC Divider Wall Compliant with UL508/UL508A Standards for Industrial Equipment/ Industrial Control Panels**

Separation of circuits is required under certain installation practices within a control panel. As required in UL508/UL508A a factory-installed conductor shall be separated from a conductor used in a different circuit when the conductors are not insulated for the maximum voltage of either circuit. In an installation where separation utilizing the method of air spacing is not appropriate, an insulating barrier (such as wiring duct with divider wall) is allowed. The barrier shall be manufactured from an insulating material exhibiting minimum properties described in UL508, section 15. These properties include High Current Arc Resistance to Ignition (HAI), Hot Wire Ignition (HWI), Comparative Tracking Index (CTI), electrical Relative Thermal Index (RTI) and flame class.

*PANDUIT*® PVC divider wall material is compliant with UL508, section 15.

### ***PANDUIT*® Wiring Duct Compliant with DIN 43 659**

This European standard specifies dimensions for slotted trunkings that will be used in electrical switchgear assemblies and that conform to the corresponding requirements in DIN VDE 0660 Part 506. The dimensions specified within the standard include:

- The channel mounting hole pattern
- Mounting hole slot dimensions
- Mounting hole pitch and location
- The distance from first to last like size mounting hole
- Minimum overall product length

*PANDUIT*® Type MC, TMC, and NNC wiring duct conform to this standard.





PANDUCT® Wiring Duct
Alphanumeric Part Number Index

Table with 2 columns: Part Number, Page Number. Rows include ABM112-A-C, ABM2S-A-C, ABMM-A-C, ABMT-A-C, ABMT-A-C20, ABMT-S6-C, ABMT-S6-C20.

C

Table with 2 columns: Part Number, Page Number. Rows include C.5LG6, C.75BL6, C.75LG6, C1.5BL6, C1.5LG6, C100IG2, C1BL6, C1LG6, C2.5BL6, C2.5LG6, C25IG2, C2BL6, C2LG6, C37IG2, C3BL6, C3LG6, C4BL6, C4LG6, C50IG2, C62IG2, C6LG6, C75IG2, CS1BL6, CS1LG6, CS1WH6, CSC1BL6, CSC1LG6, CSC1WH6, CSP1.5LG-Q, CSP1LG-Q, CSP2LG-Q, CSP3LG-Q.

Table with 2 columns: Part Number, Page Number. Rows include CSP4LG-Q, CSPC1.5LG-Q, CSPC1LG-Q, CSPC2LG-Q, CSPC3LG-Q, CSPC4LG-Q.

D

Table with 2 columns: Part Number, Page Number. Rows include D1.5H6, D1.5X2LG6, D1.5X3LG6, D1.5X4LG6, D1H6, D1X2LG6, D1X3LG6, D1X4LG6, D2.5X3LG6, D2H6, D2X2LG6, D2X3LG6, D2X4LG6, D3H6, D3X2LG6, D3X3LG6, D3X4LG6, D4H6, D4X2LG6, D4X3LG6, D4X4LG6, D50H2, D75H2, D100H2, DB-C, DCT, DCT-BLD, DCT-RI, DFCT, DJS1LG6, DJS1WH6, DJSP1.5LG-Q, DJSP2LG-Q.

Overview

Control Panel

Special Environment

Data & Voice

Tools & Accessories

Technical Info

Index

# Wiring Duct *Index*

Part Number	Page Number
DJSP3LG-Q	E8
DJSP4LG-Q	E8
DNT-100	E14
<b>F</b>	
F.5X.5LG6	B6
F.5X1LG6	B6
F.75X.75LG6	B6
F.75X1.5LG6	B6
F1-C	E10
F1.5X1.5LG6	B6
F1.5X1LG6	B6
F1.5X2LG6	B6
F1.5X3LG6	B6
F1.5X4LG6	B6
F1X1.5LG6	B6
F1X1LG6	B6
F1X2LG6	B6
F1X3LG6	B6
F1X4LG6	B6
F2-C	E10
F2X1.5LG6	B6
F2X1LG6	B6
F2X2LG6	B6
F2X3LG6	B6
F2X4LG6	B6
F2X5LG6	B6
F3-C	E10
F3X1LG6	B6
F3X2LG6	B6
F3X3LG6	B6
F3X4LG6	B6
F3X5LG6	B6
F4-C	E10
F4X2LG6	B6
F4X3LG6	B6
F4X4LG6	B6
F4X5LG6	B6
FL12X12LG-A	E4
FL25X25LG-A	E4
FL50X50LG-A	E4
FMWR-C	E7
FS.5X.5LG6NM	D8
FS.5X1LG6NM	D8

Part Number	Page Number
FS.75X.75LG6NM	D8
FS1.5X1.5LG6NM	D8
FS1.5X1LG6NM	D8
FS1.5X2LG6NM	D8
FS1.5X3LG6NM	D8
FS1X1.5LG6NM	D8
FS1X1LG6NM	D8
FS1X2LG6NM	D8
FS1X3LG6NM	D8
FS1X4LG6NM	D8
FS2X1.5LG6NM	D8
FS2X1LG6NM	D8
FS2X2LG6NM	D8
FS2X3LG6NM	D8
FS2X4LG6NM	D8
FS3X1LG6NM	D8
FS3X2LG6NM	D8
FS3X3LG6NM	D8
FS3X4LG6NM	D8
FS3X5LG6NM	D8
FS4X2LG6NM	D8
FS4X3LG6NM	D8
FS4X4LG6NM	D8
FS4X5LG6NM	D8
FS6X4LG6NM	D8
FWR-C	E7
<b>G</b>	
G.5X.5LG6	B4
G.5X1LG6	B4
G.5X2LG6	B4
G.5X4LG6	B4
G.75X.75LG6	B4
G.75X1.5LG6	B4
G.75X1LG6	B4
G.75X2BL6	D10
G.75X2LG6	B4
G1.5X1.5BL6	D10
G1.5X1.5LG6	B4
G1.5X1LG6	B4
G1.5X2BL6	D10
G1.5X2LG6	B4
G1.5X3BL6	D10
G1.5X3LG6	B4

Control Panel

Special Environment

Voice &amp; Data

Tools &amp; Accessories

Technical Info

Index

Part Number	Page Number
G1.5X4BL6	.D10
G1.5X4LG6	.B4
G1X1.5BL6	.D10
G1X1.5LG6	.B4
G1X1BL6	.D10
G1X1LG6	.B4
G1X2BL6	.D10
G1X2LG6	.B4
G1X3BL6	.D10
G1X3LG6	.B4
G1X4BL6	.D10
G1X4LG6	.B4
G2.5X3BL6	.D10
G2.5X3LG6	.B4
G2X1.5LG6	.B4
G2X1BL6	.D10
G2X1LG6	.B4
G2X2BL6	.D10
G2X2LG6	.B4
G2X3BL6	.D10
G2X3LG6	.B4
G2X4BL6	.D10
G2X4LG6	.B4
G2X5LG6	.B4
G3X1LG6	.B4
G3X2BL6	.D10
G3X2LG6	.B4
G3X3BL6	.D10
G3X3LG6	.B4
G3X4BL6	.D10
G3X4LG6	.B4
G3X5LG6	.B4
G4X1.5LG6	.B4
G4X2BL6	.D10
G4X2LG6	.B4
G4X3BL6	.D10
G4X3LG6	.B4
G4X4BL6	.D10
G4X4LG6	.B4
G4X5BL6	.D10
G4X5LG6	.B4
G6X4LG6	.B4

Part Number	Page Number
<b>H</b>	
H1.5X2BL6	.D6
H1.5X2LG6	.B12
H1.5X3BL6	.D6
H1.5X3LG6	.B12
H2X2BL6	.D6
H2X2LG6	.B12
H2X3BL6	.D6
H2X3LG6	.B12
H2X4BL6	.D6
H2X4LG6	.B12
H3X3BL6	.D6
H3X3LG6	.B12
H3X4BL6	.D6
H3X4LG6	.B12
H4X4BL6	.D6
H4X4LG6	.B12
HC1.5BL6	.D6
HC1.5LG6	.B12
HC2BL6	.D6
HC2LG6	.B12
HC3BL6	.D6
HC3LG6	.B12
HC4BL6	.D6
HC4LG6	.B12
HLS-15R0	.D12
HLS-75R0	.D12
HLT3I-X0	.D12
<b>L</b>	
LPMS-S8-C	.E12
<b>M</b>	
MC100X100IG2	.B10
MC100X50IG2	.B10
MC100X62IG2	.B10
MC100X75IG2	.B10
MC25X25IG2	.B10
MC25X37IG2	.B10
MC25X50IG2	.B10
MC25X62IG2	.B10
MC25X75IG2	.B10
MC37X37IG2	.B10

Overview

Control Panel

Special Environment

Data & Voice

Tools & Accessories

Technical Info

Index

# Wiring Duct *Index*

	Part Number	Page Number	Part Number	Page Number
Control Panel	MC37X50IG2	.B10	NE4X4WH6	.C6
	MC37X62IG2	.B10	NE4X5WH6	.C6
	MC37X75IG2	.B10	NNC25X25LG2	.C4
	MC50X100IG2	.B10	NNC25X37LG2	.C4
	MC50X50IG2	.B10	NNC25X50LG2	.C4
	MC50X75IG2	.B10	NNC25X75LG2	.C4
	MC62X37IG2	.B10	NNC37X37LG2	.C4
	MC62X62IG2	.B10	NNC37X50LG2	.C4
	MC75X100IG2	.B10	NNC37X75LG2	.C4
	MC75X50IG2	.B10	NNC50X50LG2	.C4
	MC75X62IG2	.B10	NNC50X75LG2	.C4
	MC75X75IG2	.B10	NNC50X100LG2	.C4
	Special Environment			NNC75X75LG2
			NNC100X50LG2	.C4
			NNC100X75LG2	.C4
			NNC100X100LG2	.C4
			NR1-C	.E14
			NR1-M	.E14
Voice & Data				
	Tools & Accessories			
Technical Info				
	Index			



Part Number	Page Number
SNS1-C	E9
SNS1.5-C	E9
SNS2-C	E9
SNS3-C	E9
<b>T</b>	
TA1S8-C	E12
TC100BR2	C8
TC25BR2	C8
TC37BR2	C8
TC50BR2	C8
TC75BR2	C8
TM2S8-C	E11
TM3S8-C	E11
TMC100X50BR2	C8
TMC100X75BR2	C8
TMC25X37BR2	C8
TMC37X37BR2	C8
TMC50DW2	C8,E5
TMC50X50BR2	C8
TMC75DW2	C8,E5
TMC75X50BR2	C8

Part Number	Page Number
TMC75X75BR2	C8
TNR	E14
TRC2BL	D11
TRC2HDBL	D11
TRC4BL	D11
TTS-20R0	D13
TTS-35RX0	D13
<b>U</b>	
UCT3S-X0	D12
UCT5S-X0	D12
UGCTC5S-X0	D12
UGCTE3S-X0	D12
<b>W</b>	
WR2-C	E6
WR3-C	E6
WR4-C	E6
WR5-C	E6
WRS-A-C10	E6

**PANDUIT®** is a global leader in wiring and communication products, delivering end-to-end solutions in support of demanding electrical and networking requirements.

## PANDUIT® Catalogs

### Cable Ties

SA-CTCB03

- *PAN-TY*® Cable Ties
- *PAN-TY*® Clamp Ties
- *PAN-TY*® Push Mount Ties
- *PAN-TY*® Marker Ties
- *DOME-TOP*® Barb Ty Cable Ties
- *DOME-TOP*® Barb Ty Clamp Ties
- *DOME-TOP*® Barb Ty Marker Ties
- *CONTOUR-TY*™ Cable Ties
- *DURA-TY*™ Cable Ties
- *BELT-TY*™ In-Line Cable Ties
- *TAK-TY*® Hook & Loop Cable Ties
- *STA-STRAP*® Cable Ties
- Cable Tie Installation Tools
- Custom Hot Stamping

### Wiring Accessories/Abrasion Protection

SA-CTCB03

- Adhesive Backed Cable Tie Mounts
- Screw Applied Cable Tie Mounts
- Flat Cable Mounts
- Fixed Diameter Clamps
- Harness Board Accessories
- Spiral Wrap
- Grommet Edging
- Braided Expandable Sleeving
- Corrugated Loom Tubing and Fittings
- Heat Shrink Tubing
- Non-Shrink PVC Tubing
- *PAN-WRAP*™ Split Harness Wrap

### Identification Products

SA-101N315C-ID

- Hand-Held Printers
- Desktop Printers
- Labeling Software
- Computer Printable Labels
- Wire Markers
- Lockout/Tagout Products
- Voltage Markers
- Warning Labels
- Safety Signs and Tags
- Letters and Numbers

### Terminals

SA-TM03CB02A

- *PAN-TERM*® Terminals
- Ferrule End Sleeves
- *PAN-TERM*® Disconnects
- *PAN-TERM*® Splices
- *PAN-TERM*® Wire Joints
- Terminal Kits
- Ferrule End Sleeve Kits
- *REEL SMART*™ Terminal Products
- Terminal Installation Tools

### Power Connectors

SA101N15C-NL

- Copper Compression Lugs
- Copper Compression Splices
- High Voltage Lugs and Splices
- Compression Taps
- Aluminum Compression Lugs
- Aluminum Compression Splices
- Compression Connector Accessories
- Copper Mechanical Connectors
- Split Bolt Connectors
- Aluminum Mechanical Connectors - Dual Rated Connectors
- Grounding Connectors
- Crimping Tools and Dies

### Stainless Steel Products

SA-SSCB06

- *PAN-STEEL*® Stainless Steel Cable Ties
- *PAN-STEEL*® Stainless Steel Strapping
- Installation Tools
- *PAN-STEEL*® System Accessories
- *PAN-STEEL*® System Permanent Identification

### Surface Raceway

SA-SRCB02

- Office Furniture Raceway
- Cove Raceway
- *PAN-WAY*® TG-70 Surface Raceway
- *PAN-WAY*® T-70 & Twin-70 Surface Raceway
- *PAN-WAY*® T-45 Surface Raceway
- *ULTIMATE ID*™ Network Labeling System
- Faceplates, Surface Mount Outlet Boxes & Labeling Administration
- *PAN-WAY*® LD Profile Surface Raceway
- *PAN-WAY*® T130 Surface Raceway
- *PAN-POLE*™ Outlet Poles

### Network Connectivity

SA-NCCB04

- Modules
- *ULTIMATE ID*™ System
- Work Area
- Zone Cabling
- Patch Panels, Copper Patch Cords & Punchdowns
- Fiber Connectors, Enclosures & Patch Cords
- Racks & Cable Management
- Grounding and Bonding
- Fiber Routing
- Surface Raceway
- Labeling & Administration
- Cable Ties & Accessories