

# C4AQ-P, Radial, 2 or 4 Leads, 450 – 1,100 VDC, for DC Link (Automotive Grade) - 125°C with Long Life

## Overview

The C4AQ-P capacitor is a polypropylene metallized film capacitor with a rectangular, plastic box-type design filled with resin, and uses 2 or 4 tinned wires.

Automotive grade devices meet the demanding Automotive Electronics Council's AEC-Q200 qualification requirements with longer life performances at 125°C.

## Applications

Typical applications include DC filtering, DC link, power electronics, energy storage, renewable energy grid interface, motor drives, and automotive applications.

## Benefits

- Long life at 125°C
- Self-healing
- Low loss
- Low ESL
- Low profile dimensions available
- High ripple current
- High dV/dt
- High capacitance density
- High contact reliability
- Suitable for high frequency applications
- Automotive Grades (AEC-Q200)

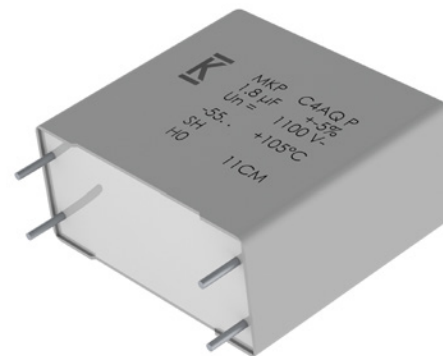

## Part Number System

C4	A	Q	Q	B	W	5270	P	3	N	J
Series	Type	Application	Rated Voltage (VDC)	Case	Terminals Code	Capacitance Code (pF)	Release	Lead Diameter (mm)	Size Code: B x H x L (mm)	Tolerance
C4 = MKP power capacitors	A = Box, wire terminals	Q = DC link Automotive Grade	G = 450 H = 600 J = 700 O = 900 Q = 1,100	B, E = Box plastic case L = Low Profile box, plastic case	U = 2 pins W = 4 pins	Digits 2 – 4 indicate the first three digits of the capacitance value. First digit indicates the number of zeros to be added.	P = Long performance life at 125°C	1 = 0.8 2 = 1.0 3 = 1.2	See dimensions table below for valid case sizes	J = 5% K = 10%

**Series Selection**

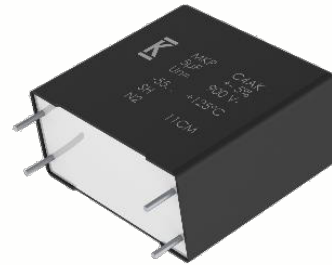

**DC-LINK, DC FILTER  
 TREE FAMILY**

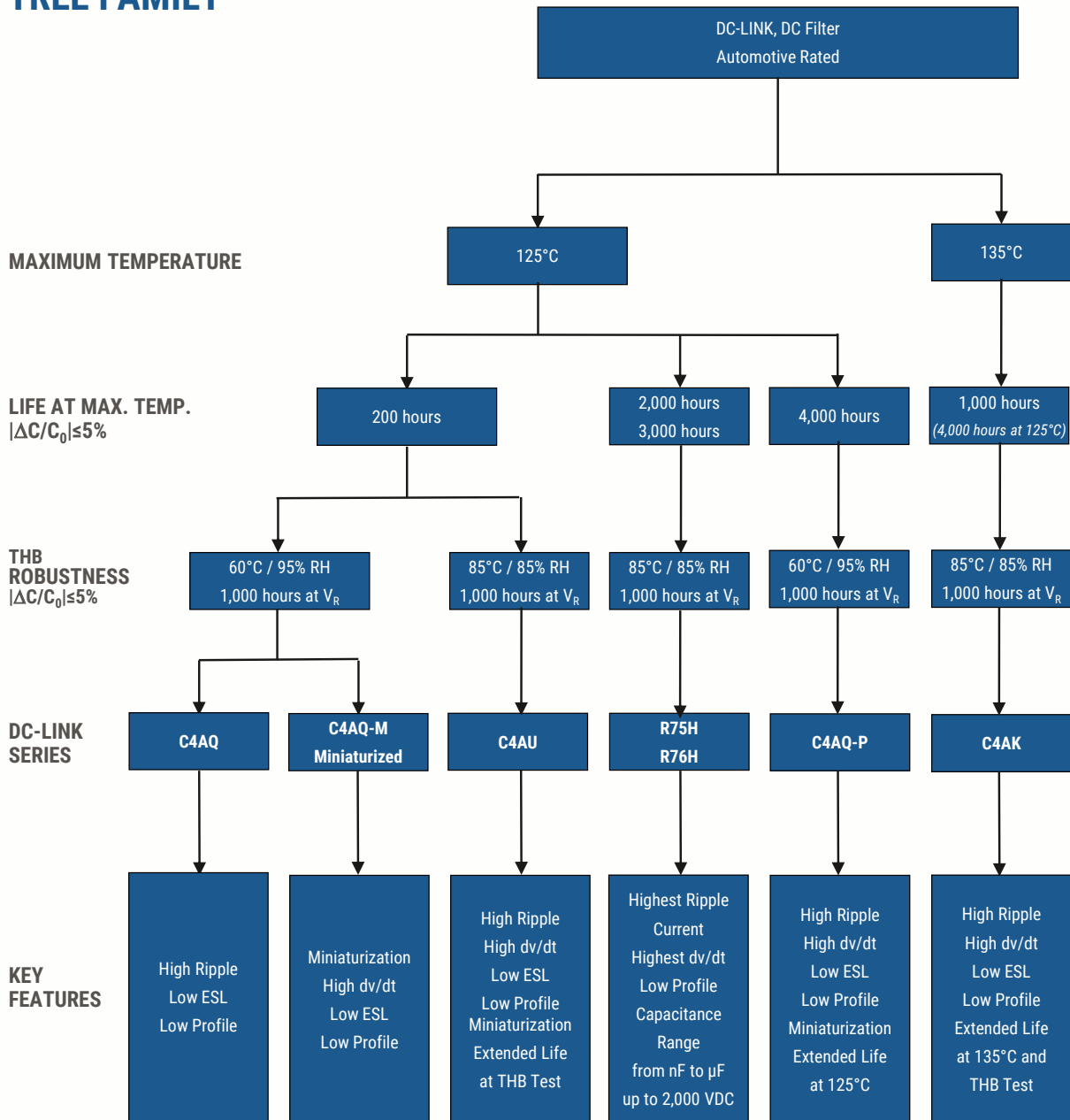

©KEMET Corporation. All Rights Reserved.

## Dimensions – Millimeters

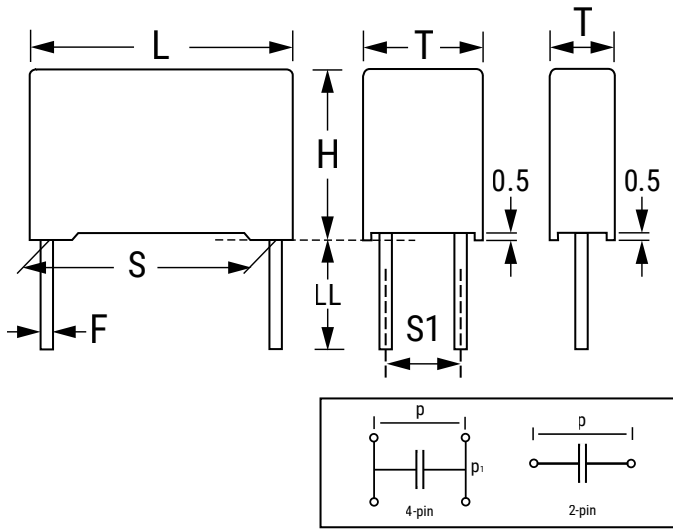

Size Code		S		S1		T		H		L		LL		F	
Digit 6	Digit 14	Nominal	Tolerance	Nominal	Tolerance	Nominal	Tolerance	Nominal	Tolerance	Nominal	Tolerance	Nominal	Tolerance	Nominal	Tolerance
B	W	27.5	±0.4	-	-	11.0	+0.3/-0.7	20.0	+0.2/-0.7	31.5	+0.5/-0.7	6	+0/-2	0.8	±0.05
B	X	27.5	±0.4	-	-	13.0	+0.3/-0.7	25.0	+0.2/-0.7	31.5	+0.5/-0.7	6	+0/-2	0.8	±0.05
B	Y	27.5	±0.4	-	-	14.0	+0.3/-0.7	28.0	+0.2/-0.7	31.5	+0.5/-0.7	6	+0/-2	0.8	±0.05
B	1	27.5	±0.4	-	-	19.0	+0.3/-0.7	29.0	+0.2/-0.7	31.5	+0.5/-0.7	6	+0/-2	0.8	±0.05
B	2	27.5	±0.4	-	-	22.0	+0.3/-0.7	37.0	+0.2/-0.7	31.5	+0.5/-0.7	6	+0/-2	0.8	±0.05
B	F	37.5	±0.4	10.2	±0.4	20.0	+0.4/-0.7	40.0	+0.2/-0.7	42.0	+0.6/-0.7	6	+0/-2	1.2	±0.05
B	J	37.5	±0.4	10.2	±0.4	28.0	+0.4/-0.7	37.0	+0.2/-0.7	42.0	+0.6/-0.7	6	+0/-2	1.2	±0.05
B	L	37.5	±0.4	20.3	±0.4	30.0	+0.4/-0.7	45.0	+0.2/-0.7	42.0	+0.6/-0.7	6	+0/-2	1.2	±0.05
B	O	37.5	±0.4	20.3	±0.4	35.0	+0.4/-0.7	50.0	+0.2/-0.7	42.0	+0.6/-0.7	6	+0/-2	1.2	±0.05
B	M	52.5	±0.4	20.3	±0.4	30.0	+0.5/-0.7	45.0	+0.3/-0.7	57.5	+0.8/-0.7	6	+0/-2	1.2	±0.05
B	N	52.5	±0.4	20.3	±0.4	35.0	+0.5/-0.7	50.0	+0.3/-0.7	57.5	+0.8/-0.7	6	+0/-2	1.2	±0.05
E	A	52.5	±0.4	20.3	±0.4	45.0	+0.5/-0.7	56.0	+0.3/-0.7	57.5	+0.8/-0.7	6	+0/-2	1.2	±0.05
E	B	52.5	±0.4	20.3	±0.4	45.0	+0.5/-0.7	65.0	+0.3/-0.7	57.5	+0.8/-0.7	6	+0/-2	1.2	±0.05
L	1	27.5	±0.4	-	-	21.0	+0.3/-0.7	12.5	+0.2/-0.7	32.0	+0.5/-0.7	6	+0/-2	0.8	±0.05
L	2	27.5	±0.4	-	-	24.0	+0.3/-0.7	15.0	+0.2/-0.7	32.0	+0.5/-0.7	6	+0/-2	0.8	±0.05
L	3	37.5	±0.4	10.2	±0.4	24.0	+0.4/-0.7	19.0	+0.2/-0.7	41.5	+0.6/-0.7	6	+0/-2	1.2	±0.05
L	4	37.5	±0.4	10.2	±0.4	24.0	+0.4/-0.7	15.0	+0.2/-0.7	41.5	+0.6/-0.7	6	+0/-2	1.2	±0.05
L	6	37.5	±0.4	20.3	±0.4	35.0	+0.4/-0.7	24.0	+0.2/-0.7	42.0	+0.6/-0.7	6	+0/-2	1.2	±0.05
L	8	37.5	±0.4	20.3	±0.4	43.0	+0.4/-0.7	25.0	+0.2/-0.7	42.0	+0.6/-0.7	6	+0/-2	1.2	±0.05
L	9	27.5	±0.4	-	-	31.0	+0.3/-0.7	19.0	+0.2/-0.7	32.0	+0.5/-0.7	6	+0/-2	0.8	±0.05

## Qualification

Reference Standards	IEC 61071, EN 61071, VDE0560
Climatic Category	55/105/56 according to IEC 60068-1

Automotive grade products meet or exceed the requirements outlined by the Automotive Electronics Council. Details regarding test methods and conditions are referenced in document AEC-Q200, Stress Test Qualification for Passive Components. For additional information regarding the Automotive Electronics Council and AEC-Q200, visit the AEC website at [www.aecouncil.com](http://www.aecouncil.com).

## General Technical Data

Dielectric	Polypropylene metallized film, non-inductive type, self-healing property
Application	DC filtering, DC link
Special Features	AEC-Q200 qualified
Climatic Category	55/105/56 IEC 60068-1
Temperature Range	-55°C to +125°C
Endurance Test	500 hours at $1.3 \times V_{OP} + C/D$ + 500 hours at $1.3 \times V_{OP}$ at 70°C, 85°C, 105°C, 125°C
Standard	IEC 61071, EN 61071, VDE0560, AEC-Q200
Protection	Solvent resistant plastic case UL 94 V-0 compliant Thermosetting resin sealing UL 94 V-0 compliant
Installation	Any position
Leads	Tinned wires, standard lead wire length 6 (+0/-2) mm
Packaging	Packed in cardboard trays with protection for the terminals
RoHS Compliance	Compliant with Directive 2002/95/EC and Directive 2011/65/EU of the European Parliament and the Council of the EU on 8 June 2011, including the Commission Delegated Directive (EU) 2015/863 that amended Annex II to Directive 2011/65/EU.

## Electrical Characteristics

Rated Capacitance Range	1 – 210 $\mu$ F
Rated Voltage ( $V_{NDC}$ ) Range	450 – 1,100 VDC
Capacitance Tolerance	$\pm 5\%$ (J) or $\pm 10\%$ (K) measured at $T = +25^{\circ}\text{C} \pm 5^{\circ}\text{C}$
Dissipation Factor PP Typical ( $\text{tg}\delta_0$ )	$\leq 0.0002$ at 10 kHz with $T = 25^{\circ}\text{C} \pm 5^{\circ}\text{C}$
Surge Voltage	$1.5 * V_{NDC}$ for maximum 10 times in a lifetime at $25^{\circ}\text{C} \pm 5^{\circ}\text{C}$
Overvoltage (IEC 61071)	$1.15 * V_{NDC}$ for maximum 30 minutes, once per day
	$1.3 * V_{NDC}$ for maximum 1 minute, once per day
Peak Non-Repetitive Current	$1.5 * I_{PKR}$ for maximum 1,000 times in a lifetime
Insulation Resistance	$IR \times C \geq 30.000$ seconds at 100 VDC 1 minute at $T = +25^{\circ}\text{C} \pm 5^{\circ}\text{C}$
Capacitance Deviation in Operation	$\pm 2.0\%$ maximum on capacitance value measured at $T = +25^{\circ}\text{C} \pm 5^{\circ}\text{C}$
Temperature Storage	$-40$ to $+80^{\circ}\text{C}$
Storage time	$\leq 36$ months from the date marked on the label glued to the package
Permissible Relative Humidity - Storage	Annual average $\leq 70\%$ , 85% on 30 days/year randomly distributed throughout year. Dewing not admissible.

## Life Expectancy

Life Expectancy	100,000 hours at $V_{NDC}$ at hot spot temperature $T_{HS} = +85^{\circ}\text{C}$
	19,000 hours at $V_{OP105}$ at hot spot temperature $T_{HS} = +105^{\circ}\text{C}$
	4,000 hours at $V_{OP85}$ at hot spot temperature $T_{HS} = +125^{\circ}\text{C}$
Capacitance Drop at End of Life	$-5\%$ (typical)
Failure Rate IEC 61709	$\leq 140$ FIT at $V_{NDC}$ at hot spot temperature $T_{HS} = +85^{\circ}\text{C}$

## Test Method

Test Voltage Between Terminals	$1.5 * V_{NDC}$ for 10 seconds or $1.65 * V_{NDC}$ for 2 seconds, at $T = +25^{\circ}\text{C} \pm 5^{\circ}\text{C}$
Test Voltage Between Terminals and Case	3.2 k VAC 50 Hz for 2 seconds
Damp Heat	IEC 60068-2-78
Change of Temperature	IEC 60068-2-14
Biased Humidity Test 40°C/93% R.H. at $V_{NDC}$ - 1,000 hours	$ \Delta C/C_0  \leq 5\%$ $ \Delta DF/DF_0  \leq 200\%$ (at 10 kHz) $IR \geq 50\%$ of initial limit
Biased Humidity Test 60°C/95% R.H. at $V_{NDC}$ - 1,000 hours	$ \Delta C/C_0  \leq 5\%$ $ \Delta DF/DF_0  \leq 200\%$ (at 10 kHz) $IR \geq 100 \text{ M}\Omega$
Biased Humidity Test 85°C/85% R.H. at $0.55 * V_{NDC}$ - 1,000 hours	$ \Delta C/C_0  \leq 5\%$ $ \Delta DF  \leq 0.005$ (at 1 kHz) $IR \geq 100 \text{ M}\Omega$

## Operative Voltage Derating

	Symbol	Voltage (VDC)					Life Expectancy (Hours)
Operating Voltage at 70°C ( $T_{HS}$ )	$V_{OP70}$	500	650	800	1100	1,300	100,000
Rated Voltage at 85°C ( $T_{HS}$ )	$V_{NDC}$	450	600	700	900	1,100	100,000
Operating Voltage at 105°C ( $T_{HS}$ )	$V_{OP105}$	350	450	550	700	850	19,000
Operating Voltage at 115°C ( $T_{HS}$ )	$V_{OP115}$	315	420	490	630	770	4,000
Operating Voltage at 125°C ( $T_{HS}$ )	$V_{OP125}$	270	360	420	540	660	4,000

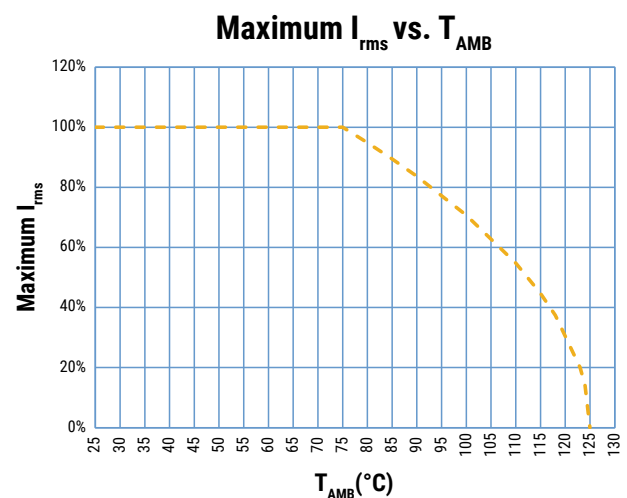
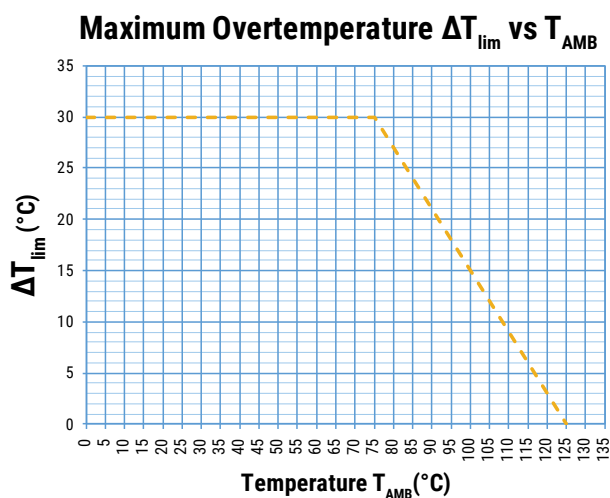

$T_{AMB}$  is the maximum ambient temperature surrounding the capacitor or hottest contact point (e.g. tracks), whichever is higher, in the worst operation conditions in °C.

## Typical Waveforms

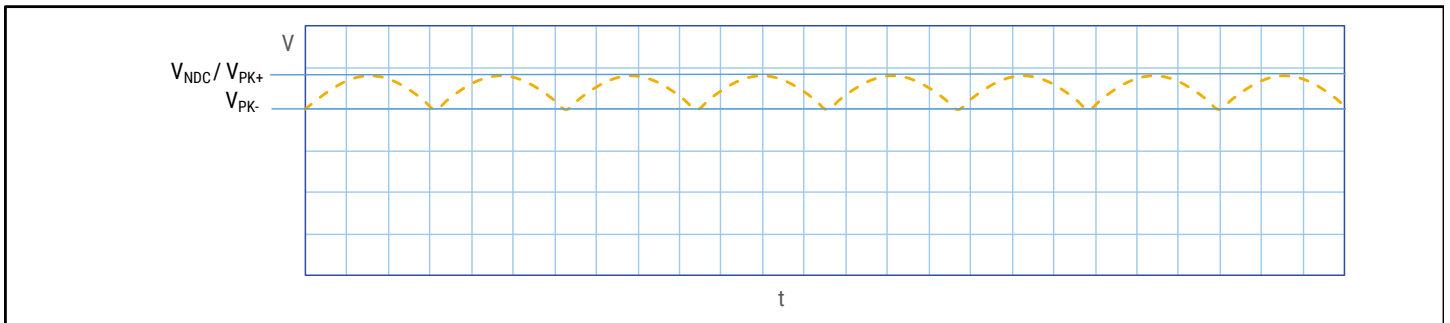
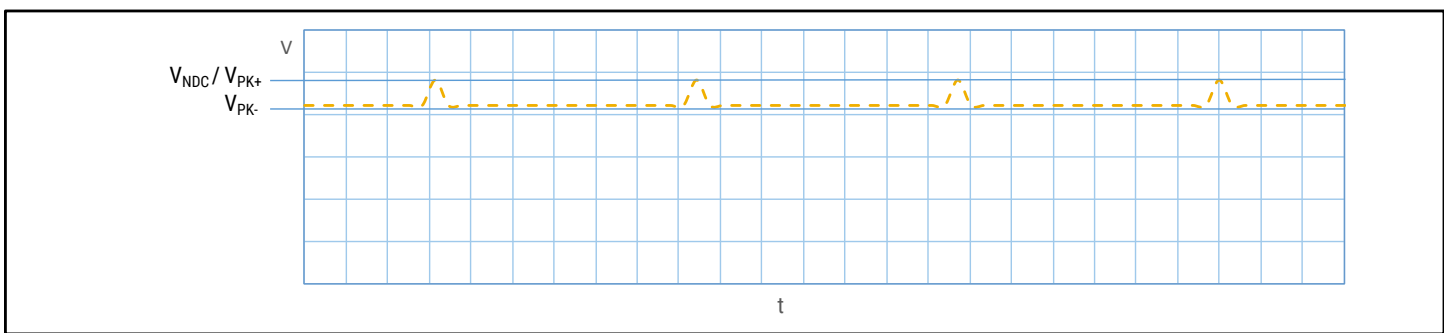
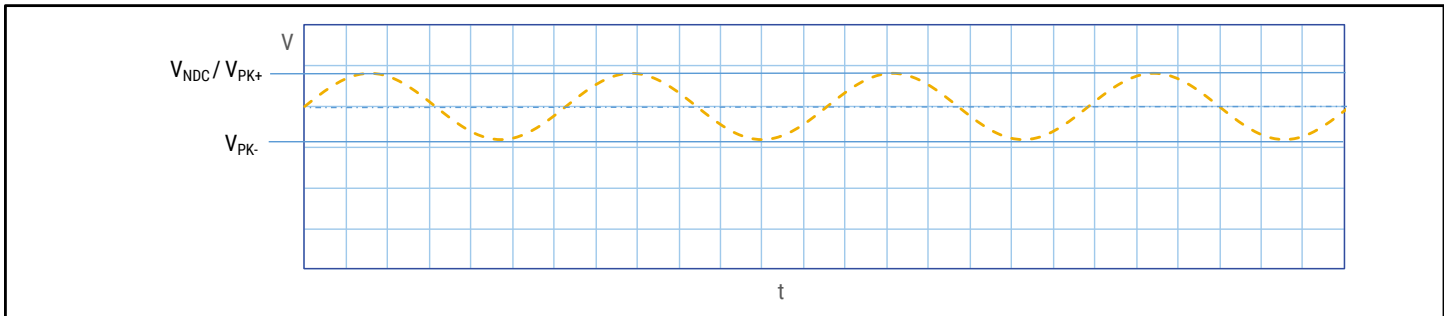

The applied peak-to-peak ripple voltage shall not exceed  $0.2 \times V_{NDC}$ .  
The peak voltage shall not exceed the rated voltage  $V_{NDC}$ .

## Life Expectancy/Failure Quota Graphs

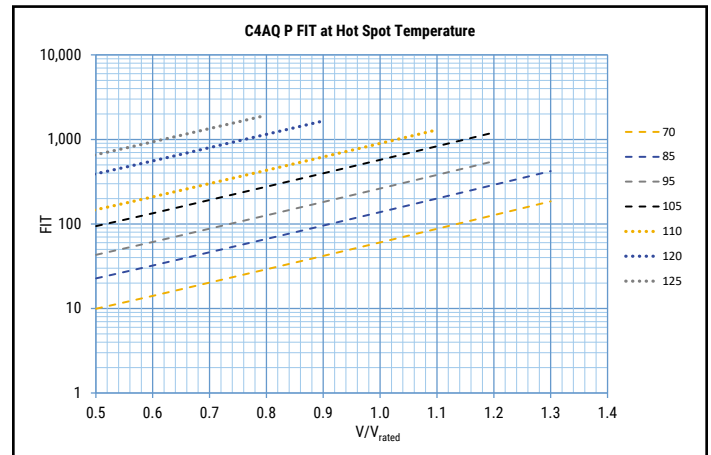
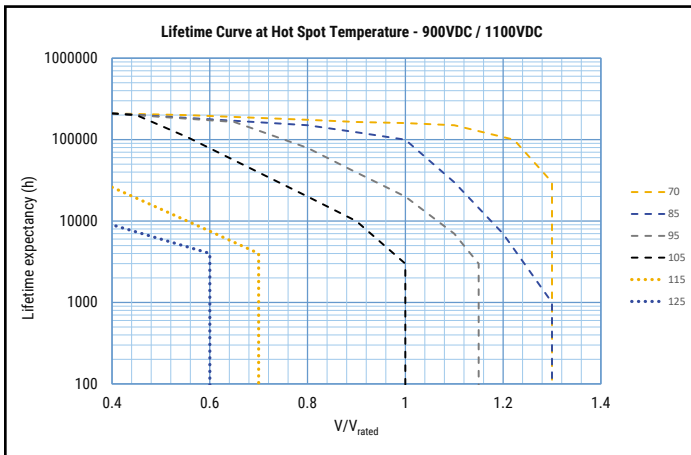
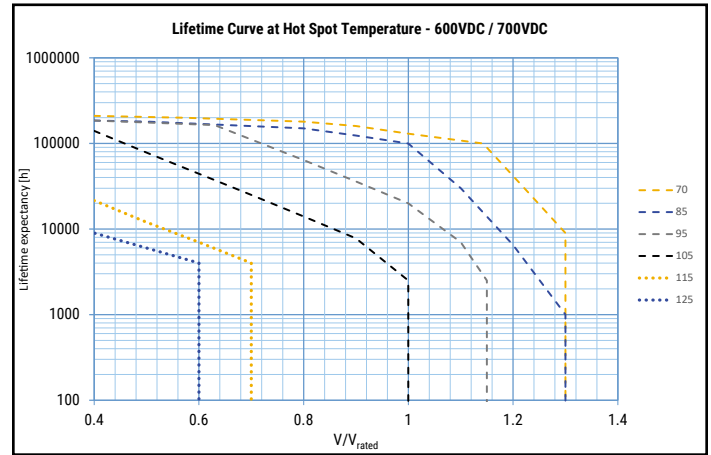
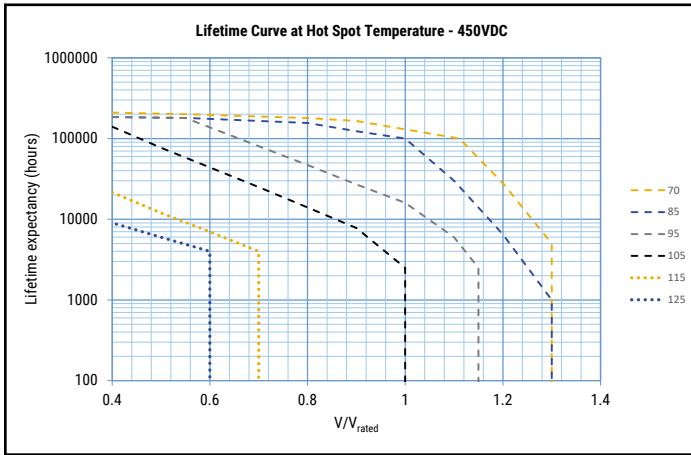



## Environmental Compliance

As a leading global supplier of electronic components and an environmentally conscious company, KEMET continually aspires to improve the environmental effects of our manufacturing processes and our finished electronic components.

In Europe (RoHS Directive) and in some other geographical areas such as China (China RoHS), legislation has been enacted to prevent or otherwise limit the use of certain hazardous materials, including lead (Pb), in electronic equipment. KEMET monitors legislation globally to ensure compliance and endeavors to adjust our manufacturing processes and/or electronic components as may be required by applicable law.

For military, medical, automotive, and some commercial applications, the use of lead (Pb) in the termination is necessary and/or required by design. KEMET is committed to communicating RoHS compliance to our customers. Information related to RoHS compliance will be provided in data sheets and using specific identifiers on the packaging labels.

All KEMET power film capacitors are RoHS compliant.

---

## Materials & Environment

The selection of raw materials that KEMET uses for the production of its electronic components is the result of extensive experience. KEMET directs specific attention toward environmental protection. KEMET selects its suppliers according to ISO 9001 standards and performs statistical analyses on raw materials before acceptance for use in manufacturing our electronic components. All materials are, to the best of KEMET's knowledge, non-toxic and free from cadmium; mercury; chrome and compounds; polychlorine triphenyl (PCB); bromide and chlorinedioxins bromurate clorurate; CFC and HCFC; and asbestos.

## Dissipation Factor

Dissipation factor is a complex function involved with capacitor inefficiency. The  $\tan\delta$  may vary up and down with increased temperature. For more information, refer to Performance Characteristics.

## Sealing

### Hermetically Sealed Capacitors

As the temperature increases, the pressure inside the capacitor increases. If the internal pressure is high enough, it can cause a breach in the capacitor. Such a breach can result in leakage, impregnation, filling fluid, or moisture susceptibility.

### Barometric Pressure

The altitude at which hermetically sealed capacitors are operated controls the capacitor's voltage rating. As the barometric pressure decreases, the susceptibility to terminal arc-over increases. Non-hermetic capacitors can be affected by internal stresses due to pressure changes. These effects can be in the form of capacitance changes, dielectric arc-over, and/or low insulation resistance. Altitude can also affect heat transfer. Heat that is generated in an operation cannot be dissipated properly, and high  $RI^2$  losses and eventual failure can result.

**Table 1 – Ratings & Part Number Reference**

Cap Value (µF)	VDC	Dimensions (mm)					dV/dt V/µs	lpkr Apk	ESL nH	ESR <sub>typ</sub> at 10 kHz mΩ	Irms* 75°C at 10 kHz Arms	Rth (HS/Amb) (°C/W)	Packaging Quantity	PART NUMBER	
		T	H	L	S	S1									
<b>V<sub>NDC</sub> at 85°C = 450 VDC; V<sub>OP105</sub> at 105°C = 350 VDC; V<sub>OP115</sub> at 115°C = 310 VDC; V<sub>OP125</sub> at 125°C = 270 VDC</b>															
5.6	450	11	20	31.5	27.5	\	65	364	17	14.0	6.8	44	256	C4AQGBU4560P1WK	
10	450	13	25	31.5	27.5	\	65	650	22	8.6	9.6	36	234	C4AQGBU5100P1XK	
12.5	450	14	28	31.5	27.5	\	65	813	24	7.4	11.0	33	96	C4AQGBU5125P1YK	
15	450	19	29	31.5	27.5	\	65	975	25	6.4	12.6	29	72	C4AQGBU5150P11K	
25	450	22	37	31.5	27.5	\	65	1625	28	4.8	16.0	23	64	C4AQGBU5250P12K	
40	450	20	40	42	37.5	10.2	30	1200	12	3.7	19.6	20	58	C4AQGBW5400P3FK	
50	450	28	37	42	37.5	10.2	30	1500	10	3.1	22.8	18	36	C4AQGBW5500P3JK	
70	450	30	45	42	37.5	20.3	30	2100	13	2.3	29.1	15	36	C4AQGBW5700P3LK	
90	450	35	50	42	37.5	20.3	30	2700	14	1.9	35.1	13	30	C4AQGBW5900P3OK	
100	450	30	45	57.5	52.5	20.3	15	1500	13	3.2	27.4	12	27	C4AQGBW6100P3MK	
130	450	35	50	57.5	52.5	20.3	15	1950	15	2.5	33.3	10	23	C4AQGBW6130P3NK	
170	450	45	56	57.5	52.5	20.3	15	2550	17	2.0	41.6	8	18	C4AQGEW6170P3AK	
210	450	45	65	57.5	52.5	20.3	15	3150	19	1.8	47.7	7	18	C4AQGEW6210P3BK	
<b>V<sub>NDC</sub> at 85°C = 600 VDC; V<sub>OP105</sub> at 105°C = 450 VDC; V<sub>OP115</sub> at 115°C = 400 VDC; V<sub>OP125</sub> at 125°C = 350 VDC</b>															
3.3	600	11	20	31.5	27.5	\	65	215	17	18.7	5.9	44	256	C4AQHBU4330P1WJ	
5.6	600	13	25	31.5	27.5	\	65	364	22	11.8	8.2	36	234	C4AQHBU4560P1XJ	
7	600	14	28	31.5	27.5	\	65	455	24	9.9	9.5	33	96	C4AQHBU4700P1YJ	
10	600	19	29	31.5	27.5	\	65	650	25	7.5	11.7	29	72	C4AQHBU5100P11J	
15	600	22	37	31.5	27.5	\	65	975	28	5.8	14.6	23	64	C4AQHBU5150P12J	
20	600	20	40	42	37.5	10.2	30	600	12	5.8	15.6	20	58	C4AQHBW5200P3FJ	
30	600	28	37	42	37.5	10.2	30	900	10	4.0	19.9	18	36	C4AQHBW5300P3JJ	
40	600	30	45	42	37.5	20.3	30	1200	13	3.1	24.9	15	36	C4AQHBW5400P3LJ	
50	600	35	50	42	37.5	20.3	30	1500	14	2.5	29.9	13	30	C4AQHBW5500P3OJ	
55	600	30	45	57.5	52.5	20.3	15	825	13	4.5	23.0	12	27	C4AQHBW5550P3MJ	
75	600	35	50	57.5	52.5	20.3	15	1125	15	3.4	28.7	10	23	C4AQHBW5750P3NJ	
110	600	45	56	57.5	52.5	20.3	15	1650	17	2.4	37.9	8	18	C4AQHEW6110P3AJ	
130	600	45	65	57.5	52.5	20.3	15	1950	19	2.1	42.9	7	18	C4AQHEW6130P3BJ	
<b>V<sub>NDC</sub> at 85°C = 700 VDC; V<sub>OP105</sub> at 105°C = 550 VDC; V<sub>OP115</sub> at 115°C = 470 VDC; V<sub>OP125</sub> at 125°C = 400 VDC</b>															
2.7	700	11	20	31.5	27.5	\	65	176	17	20.1	5.7	44	256	C4AQJBU4270P1WJ	
4	700	13	25	31.5	27.5	\	65	260	22	14.2	7.5	36	234	C4AQJBU4400P1XJ	
5	700	14	28	31.5	27.5	\	65	325	24	11.8	8.7	33	96	C4AQJBU4500P1YJ	
8	700	19	29	31.5	27.5	\	65	520	25	8.0	11.2	29	72	C4AQJBU4800P11J	
12.5	700	22	37	31.5	27.5	\	65	813	28	6.1	14.1	23	64	C4AQJBU5125P12J	
15	700	20	40	42	37.5	10.2	30	450	12	6.8	14.5	20	58	C4AQJBW5150P3FJ	
20	700	28	37	42	37.5	10.2	30	600	10	5.2	17.4	18	36	C4AQJBW5200P3JJ	
30	700	30	45	42	37.5	20.3	30	900	13	3.5	23.2	15	36	C4AQJBW5300P3LJ	
40	700	35	50	42	37.5	20.3	30	1200	14	2.8	28.7	13	30	C4AQJBW5400P3OJ	
45	700	30	45	57.5	52.5	20.3	15	675	13	4.8	22.3	12	27	C4AQJBW5450P3MJ	
55	700	35	50	57.5	52.5	20.3	15	825	15	4.0	26.4	10	23	C4AQJBW5550P3NJ	
60	700	35	50	57.5	52.5	20.3	15	900	15	3.6	27.5	10	23	C4AQJBW5600P3NJ	
85	700	45	56	57.5	52.5	20.3	15	1275	17	2.8	35.8	8	18	C4AQJEW5850P3AJ	
100	700	45	65	57.5	52.5	20.3	15	1500	19	2.4	40.6	7	18	C4AQJEW6100P3BJ	
Cap Value (µF)	VDC	T	H	L	S	S1	V/µs	Apk	nH	mΩ	Arms	(°C/W)	Packaging Quantity	PART NUMBER	
		Dimensions (mm)					dV/dt	lpkr	ESL	ESR <sub>typ</sub> at 10 kHz	Irms* 75°C at 10 kHz	Rth (HS/Amb)			

(\* ) I<sub>rms</sub> value that leads to a ΔT of ≈ 30°C in the hot spot > T<sub>HS</sub> = T<sub>AMB</sub> + ΔT = 75°C + 30°C = 105°C. Attention: Hot spot at 105°C reduced the life time!

**Table 1 – Ratings & Part Number Reference cont.**

Cap Value (µF)	VDC	Dimensions (mm)					dV/dt V/µs	Ipkr Apk	ESL nH	ESR <sub>typ</sub> at 10 kHz mΩ	Irms* 75°C at 10 kHz Arms	Rth (HS/Amb) (°C/W)	Packaging Quantity	PART NUMBER
		T	H	L	S	S1								
<b>V<sub>NDC</sub> at 85°C = 900 VDC; V<sub>OP105</sub> at 105°C = 700 VDC; V<sub>OP115</sub> at 115°C = 600 VDC; V<sub>OP125</sub> at 125°C = 500 VDC</b>														
1.5	900	11	20	31.5	27.5	\	70	105	17	28.9	4.8	44	256	C4AQ0BU4150P1WJ
2.7	900	13	25	31.5	27.5	\	70	189	22	16.8	6.9	36	234	C4AQ0BU4270P1XJ
3.3	900	14	28	31.5	27.5	\	70	231	24	14.2	7.9	33	96	C4AQ0BU4330P1VJ
5	900	19	29	31.5	27.5	\	70	350	25	10.0	10.1	29	72	C4AQ0BU4500P11J
8	900	22	37	31.5	27.5	\	70	560	28	7.3	13.2	23	64	C4AQ0BU4800P12J
12	900	20	40	42	37.5	10.2	35	420	12	6.9	14.4	20	58	C4AQ0BW5120P3FJ
14	900	28	37	42	37.5	10.2	35	490	10	5.9	16.3	18	36	C4AQ0BW5140P3JJ
20	900	30	45	42	37.5	20.3	35	700	13	4.3	21.2	15	36	C4AQ0BW5200P3LJ
25	900	35	50	42	37.5	20.3	35	875	14	3.5	25.5	13	30	C4AQ0BW5250P3OJ
30	900	30	45	57.5	52.5	20.3	15	450	13	5.7	20.4	12	27	C4AQ0BW5300P3MJ
40	900	35	50	57.5	52.5	20.3	15	600	15	4.4	25.2	10	23	C4AQ0BW5400P3NJ
55	900	45	56	57.5	52.5	20.3	15	825	17	3.3	32.5	8	18	C4AQ0EW5550P3AJ
65	900	45	65	57.5	52.5	20.3	15	975	19	2.9	37.0	7	18	C4AQ0EW5650P3BJ
<b>V<sub>NDC</sub> at 85°C = 1,100 VDC; V<sub>OP105</sub> at 105°C = 850 VDC; V<sub>OP115</sub> at 115°C = 720 VDC; V<sub>OP125</sub> at 125°C = 600 VDC</b>														
1	1,100	11	20	31.5	27.5	\	80	80	17	36.4	4.2	44	256	C4AQQBU4100P1WJ
1.8	1,100	13	25	31.5	27.5	\	80	144	22	21.0	6.2	36	234	C4AQQBU4180P1XJ
2.2	1,100	14	28	31.5	27.5	\	80	176	24	17.6	7.1	33	96	C4AQQBU4220P1VJ
3.3	1,100	19	29	31.5	27.5	\	80	264	25	12.3	9.1	29	72	C4AQQBU4330P11J
5	1,100	22	37	31.5	27.5	\	80	400	28	9.0	11.8	23	64	C4AQQBU4500P12J
8	1,100	20	40	42	37.5	10.2	40	320	12	8.7	12.9	20	58	C4AQQBW4800P3FJ
10	1,100	28	37	42	37.5	10.2	40	400	10	6.9	15.0	18	36	C4AQQBW5100P3JJ
12	1,100	30	45	42	37.5	20.3	40	480	13	5.8	18.1	15	36	C4AQQBW5120P3LJ
18	1,100	35	50	42	37.5	20.3	40	720	14	4.1	23.7	13	30	C4AQQBW5180P3OJ
20	1,100	30	45	57.5	52.5	20.3	20	400	13	7.2	18.3	12	27	C4AQQBW5200P3MJ
25	1,100	35	50	57.5	52.5	20.3	20	500	15	5.7	22.0	10	23	C4AQQBW5250P3NJ
27	1,100	35	50	57.5	52.5	20.3	20	540	15	5.4	22.8	10	23	C4AQQBW5270P3NJ
38	1,100	45	56	57.5	52.5	20.3	20	760	17	4.0	29.8	8	18	C4AQQEW5380P3AJ
45	1,100	45	65	57.5	52.5	20.3	20	900	19	3.4	34.0	7	18	C4AQQEW5450P3BJ
Cap Value (µF)	VDC	T	H	L	S	S1	dV/dt V/µs	Apk	nH	mΩ	Arms	(°C/W)	Packaging Quantity	PART NUMBER
		Dimensions (mm)												

(\* ) I<sub>rms</sub> value that leads to a ΔT of ≈ 30°C in the hot spot > T<sub>HS</sub> = T<sub>AMB</sub> + ΔT = 75°C + 30°C = 105°C. Attention: Hot spot at 105°C reduced the life time!

**Table 2 – Ratings & Part Number Reference for Low Profile Design**

Cap Value (µF)	VDC	Dimensions (mm)					dV/dt V/µs	lpkr Apk	ESL nH	ESR <sub>typ</sub> at 10 kHz mΩ	Irms* 75°C at 10 kHz Arms	Rth (HS/Amb) (°C/W)	Packaging Quantity	PART NUMBER
		T	H	L	S	S1								
<b>V<sub>NDC</sub> at 85°C = 450 VDC; V<sub>OP105</sub> at 105°C = 350 VDC; V<sub>OP115</sub> at 115°C = 310 VDC; V<sub>OP125</sub> at 125°C = 270 VDC</b>														
5.6	450	21	12.5	32	27.5	\	65	364	11	13.6	6.8	46	192	C4AAGLU4560P11K
8	450	24	15	32	27.5	\	65	520	13	10.0	8.6	39	168	C4AAGLU4800P12K
15	450	31	19	32	27.5	\	65	975	16	6.1	12.6	30	80	C4AAGLU5150P19K
12	450	24	15	41.5	37.5	10.2	30	360	7	11.8	8.6	33	132	C4AAGLU5120P34K
16	450	24	19	41.5	37.5	10.2	30	480	8	8.9	10.5	29	88	C4AAGLU5160P33K
36	450	35	24	42	37.5	20.3	30	1080	9	4.1	17.8	23	60	C4AAGLU5360P36K
45	450	43	25	42	37.5	20.3	30	1350	9	3.3	21.4	19	48	C4AAGLU5450P38K
<b>V<sub>NDC</sub> at 85°C = 600 VDC; V<sub>OP105</sub> at 105°C = 450 VDC; V<sub>OP115</sub> at 115°C = 400 VDC; V<sub>OP125</sub> at 125°C = 350 VDC</b>														
3.3	600	21	12.5	32	27.5	\	65	215	11	18.5	5.8	46	192	C4AAGLU4330P11J
5	600	24	15	32	27.5	\	65	325	13	12.7	7.7	39	168	C4AAGLU4500P12J
10	600	31	19	32	27.5	\	65	650	16	7.0	11.7	30	80	C4AAGLU5100P19J
7.5	600	24	15	41.5	37.5	10.2	30	225	7	15.2	7.6	33	132	C4AAGLU4750P34J
10	600	24	19	41.5	37.5	10.2	30	300	8	11.4	9.3	29	88	C4AAGLU5100P33J
20	600	35	24	42	37.5	20.3	30	600	10	5.8	14.8	23	60	C4AAGLU5200P36J
30	600	43	25	42	37.5	20.3	30	900	9	4.0	19.5	19	48	C4AAGLU5300P38K
<b>V<sub>NDC</sub> at 85°C = 700 VDC; V<sub>OP105</sub> at 105°C = 550 VDC; V<sub>OP115</sub> at 115°C = 470 VDC; V<sub>OP125</sub> at 125°C = 400 VDC</b>														
2.7	700	21	12.5	32	27.5	\	65	176	11	19.8	5.6	46	192	C4AAGLU4270P11J
3.8	700	24	15	32	27.5	\	65	247	13	14.5	7.1	39	168	C4AAGLU4380P12J
7.5	700	31	19	32	27.5	\	65	488	16	8.0	10.9	30	80	C4AAGLU4750P19J
5.8	700	24	15	41.5	37.5	10.2	30	174	7	17.3	7.1	33	132	C4AAGLU4580P34J
8	700	24	19	41.5	37.5	10.2	30	240	8	12.5	8.9	29	88	C4AAGLU4800P33J
15	700	35	24	42	37.5	20.3	30	450	9	6.8	13.7	23	60	C4AAGLU5150P36J
22	700	43	25	42	37.5	20.3	30	660	9	4.7	17.9	19	48	C4AAGLU5220P38J
<b>V<sub>NDC</sub> at 85°C = 900 VDC; V<sub>OP105</sub> at 105°C = 700 VDC; V<sub>OP115</sub> at 115°C = 600 VDC; V<sub>OP125</sub> at 125°C = 500 VDC</b>														
1.5	900	21	12.5	32	27.5	\	70	105	11	28.6	4.7	46	192	C4AAGLU4150P11J
2.5	900	24	15	32	27.5	\	70	175	13	17.7	6.5	39	168	C4AAGLU4250P12J
4.8	900	31	19	32	27.5	\	70	336	16	9.9	9.8	30	80	C4AAGLU4480P19J
3.8	900	24	15	41.5	37.5	10.2	35	133	7	21.2	6.4	33	132	C4AAGLU4380P34J
5	900	24	19	41.5	37.5	10.2	35	175	8	16.2	7.8	29	88	C4AAGLU4500P33J
10	900	35	24	42	37.5	20.3	35	350	9	8.1	12.5	23	60	C4AAGLU5100P36J
14	900	43	25	42	37.5	20.3	35	490	9	5.9	15.9	19	48	C4AAGLU5140P38J
<b>V<sub>NDC</sub> at 85°C = 1,100 VDC; V<sub>OP105</sub> at 105°C = 850 VDC; V<sub>OP115</sub> at 115°C = 720 VDC; V<sub>OP125</sub> at 125°C = 600 VDC</b>														
1	1,100	21	12.5	32	27.5	\	80	80	11	36.2	4.2	46	192	C4AAGLU4100P11J
1.8	1,100	24	15	32	27.5	\	80	144	13	20.7	6.0	39	168	C4AAGLU4180P12J
3.3	1,100	31	19	32	27.5	\	80	264	16	11.9	9.0	30	80	C4AAGLU4330P19J
2.6	1,100	24	15	41.5	37.5	10.2	40	104	7	26.1	5.8	33	132	C4AAGLU4260P34J
3.5	1,100	24	19	41.5	37.5	10.2	40	140	8	19.4	7.1	29	88	C4AAGLU4350P33J
7.5	1,100	35	24	42	37.5	20.3	40	300	9	9.1	11.8	23	60	C4AAGLU4750P36J
10	1,100	43	25	42	37.5	20.3	40	400	9	6.9	14.7	19	48	C4AAGLU5100P38J
Cap Value (µF)	VDC	T	H	L	S	S1	dV/dt V/µs	lpkr Apk	ESL nH	ESR <sub>typ</sub> at 10 kHz mΩ	Irms* 75°C at 10 kHz Arms	Rth (HS/Amb) (°C/W)	Packaging Quantity	PART NUMBER
		Dimensions (mm)												

(\* ) I<sub>rms</sub> value that leads to a ΔT of ≈ 30°C in the hot spot > T<sub>HS</sub> = T<sub>AMB</sub> + ΔT = 75°C + 30°C = 105°C. Attention: Hot spot at 105°C reduced the life time!

## Soldering Process

The implementation of the RoHS directive has resulted in the selection of SnAuCu (SAC) alloys, or SnCu alloys, as the primary solder material. This has increased the liquidus temperature from 183°C for a SnPb eutectic alloy to 217 – 221°C for new alloys. As a result, the heat stress to the components, even in wave soldering, has increased considerably due to higher pre-heat and wave temperatures. Polypropylene capacitors are especially sensitive to heat (the melting point of polypropylene is 160 – 170°C). Wave soldering can be destructive, especially for mechanically small polypropylene capacitors (with lead spacing of 5 – 15 mm), and great care must be taken during soldering. The recommended solder profiles from KEMET should be used. Contact KEMET with any questions. In general, the wave soldering curve from IEC Publication 61760-1 Edition 2 serves as a solid guideline for successful soldering. See Figure 1.

Reflow soldering is not recommended for through-hole film capacitors. Exposing capacitors to a soldering profile in excess of the recommended limits may result in degradation or permanent damage to the capacitors.

Do not place the polypropylene capacitor through an adhesive curing oven to cure resin for surface mount components. Insert through-hole parts after curing the surface mount parts. Contact KEMET to discuss the actual temperature profile in the oven, if through-hole components must pass through the adhesive curing process. A maximum two soldering cycles is recommended. Allow time for the capacitor surface temperature to return to normal before the second soldering cycle.

### Manual Soldering Recommendations

Following is the recommendation for manual soldering with a soldering iron.



The soldering iron tip temperature should be set at 350°C (+10°C maximum) with the soldering duration not to exceed more than 3 seconds.

### Wave Soldering Recommendations

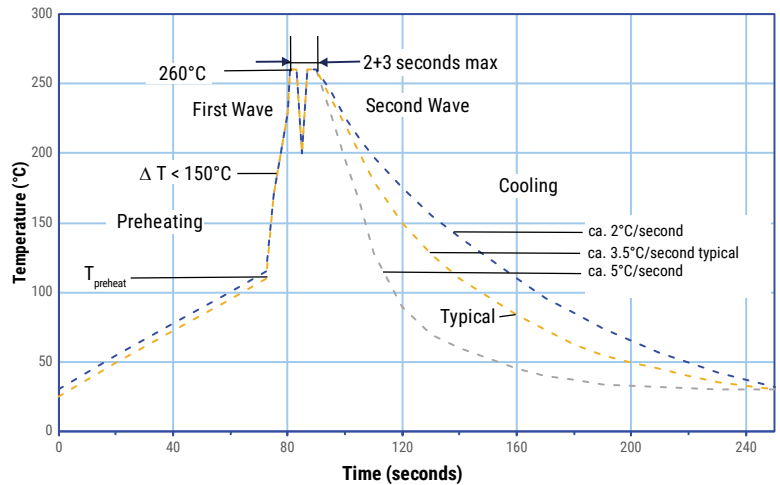

## Soldering Process cont.

### Wave Soldering Recommendations cont.

1. The tables indicates the maximum set-up temperature of the soldering process

Dielectric Film Material	Maximum Preheat Temperature		Maximum Peak Soldering Temperature	
	Capacitor Pitch $\leq 15$ mm	Capacitor Pitch $> 15$ mm	Capacitor Pitch $\leq 15$ mm	Capacitor Pitch $> 15$ mm
Polyester	130°C	130°C	270°C	270°C
Polypropylene	110°C	130°C	260°C	270°C
Paper	130°C	140°C	270°C	270°C
Polyphenylene Sulphide	150°C	160°C	270°C	270°C

2. The maximum temperature measured inside the capacitor: set the temperature so that inside the element the maximum temperature is below the limit.

Dielectric Film Material	Maximum Temperature Measured Inside the Element
Polyester	160°C
Polypropylene	110°C
Paper	160°C
Polyphenylene Sulphide	160°C

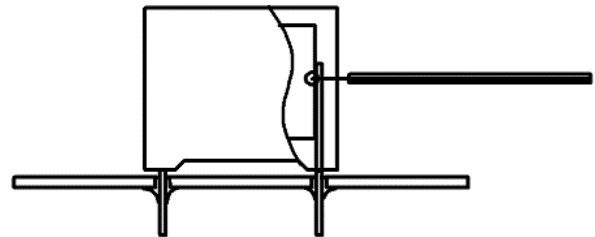

*Temperature monitored inside the capacitor.*

### Selective Soldering Recommendations

Selective dip soldering is a variation of reflow soldering. In this method, the printed circuit board with through-hole components to be soldered is pre-heated and transported over the solder bath, as in normal flow soldering, without touching the solder. When the board is over the bath, it is stopped. Pre-designed solder pots are lifted from the bath with molten solder, only at the places of the selected components, and pressed against the lower surface of the board to solder the components.

The temperature profile for selective soldering is similar to the double wave flow soldering outlined in this document. However, instead of two baths, there is only one with a time from 3 – 10 seconds. In selective soldering, the risk of overheating is greater than in double wave flow soldering, and great care must be taken so that the parts do not overheat.

## Mounting

### Resistance to Vibration and Mechanical Shock

AEC-Q200 Mechanical Stress Tests:

<b>Mechanical Shock</b>	<b>MIL-SDT-202 Method 213</b>	Test condition C Peak value 100 g, duration 6 ms, half-sine-wave (see MIL-HDBK for details)
<b>Vibration</b>	<b>MIL-SDT-202 Method 204</b>	5 g for 20 minutes, 12 cycles each of 3 orientations Use 8"X5" PCB, .031" thick. 7 secure points on one 8" side and 2 secure points at corners of opposite sides. Parts mounted within 2" from any secure point. Test from 10 – 2,000 Hz.

The capacitors are designed for PCB mounting.  
 The stand-off pipes must be in good contact with the printed circuit board.  
 The capacitor body has to be properly fixed (e.g. clamped or glued).

## Construction

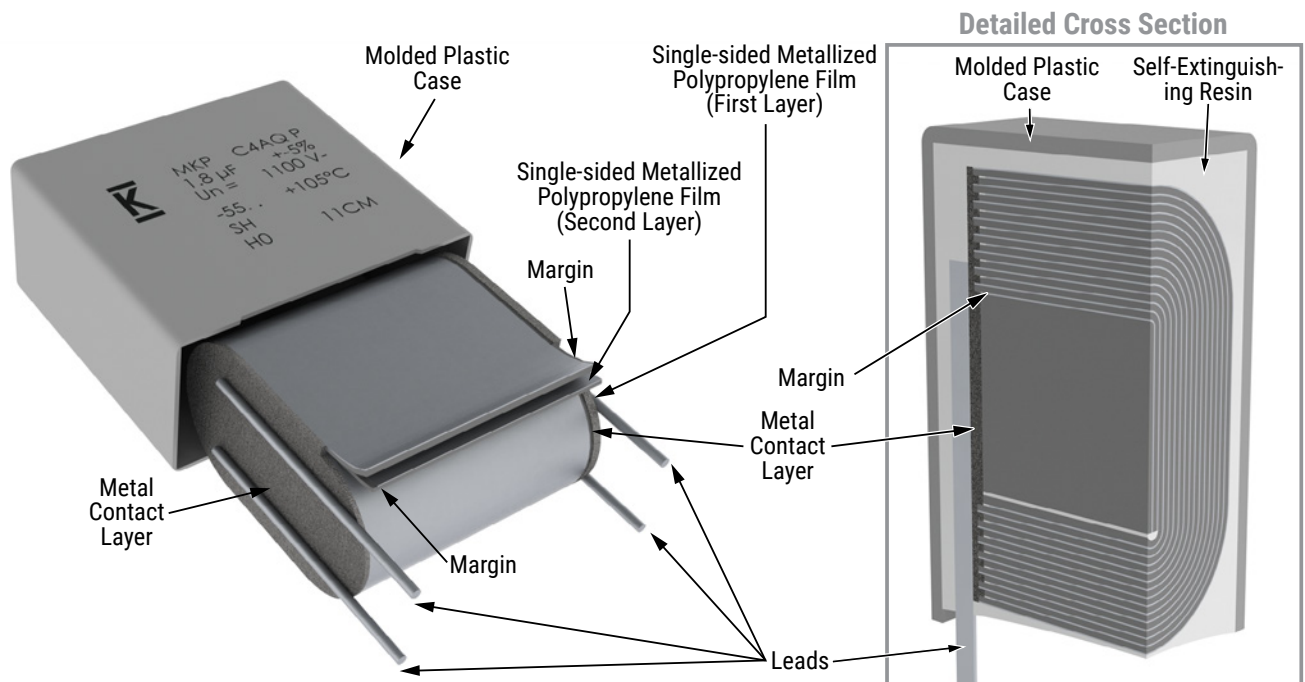



## Construction cont.

### Low Profile Version:

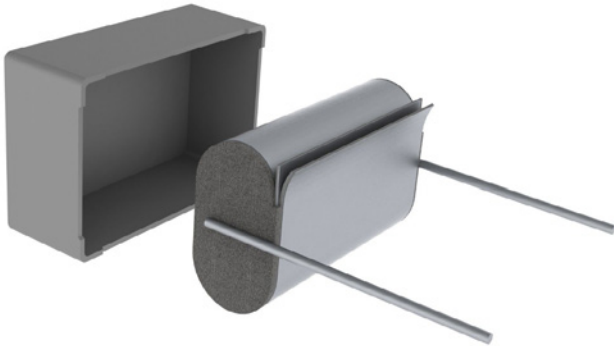

### Winding Scheme:

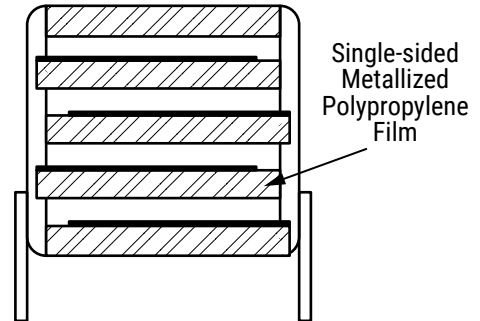

## Marking

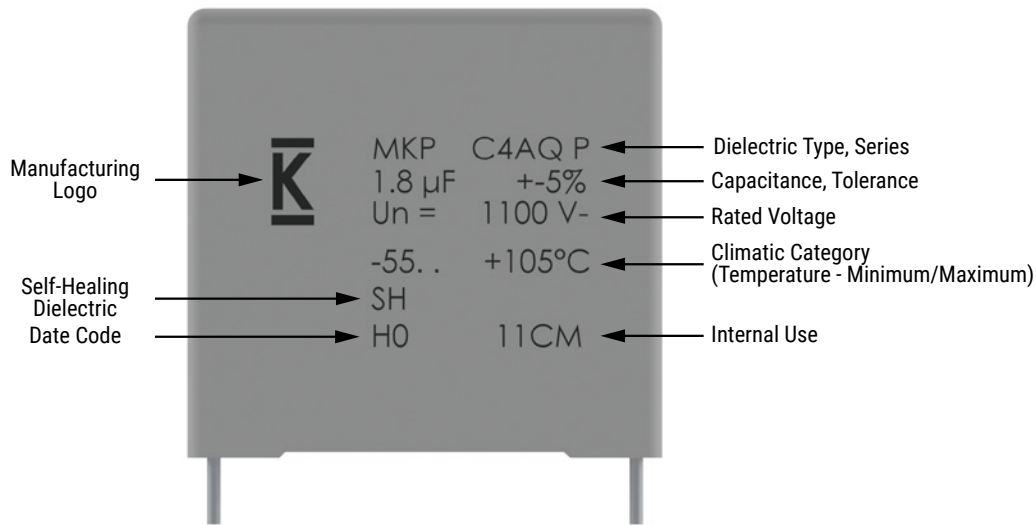

**Manufacturing Date Code (IEC-60062)**

Year	Code	Year	Code	Year	Code	Month	Code	Month	Code
2010	A	2017	J	2024	S	January	1	July	7
2011	B	2018	K	2025	T	February	2	August	8
2012	C	2019	L	2026	U	March	3	September	9
2013	D	2020	M	2027	V	April	4	October	0
2014	E	2021	N	2028	W	May	5	November	N
2015	F	2022	P	2029	X	June	6	December	D
2016	H	2023	R	2030	A				



## KEMET Electronics Corporation Sales Offices

For a complete list of our global sales offices, please visit [www.kemet.com/sales](http://www.kemet.com/sales).

---

### Disclaimer

All product specifications, statements, information and data (collectively, the "Information") in this datasheet are subject to change. The customer is responsible for checking and verifying the extent to which the Information contained in this publication is applicable to an order at the time the order is placed. All Information given herein is believed to be accurate and reliable, but it is presented without guarantee, warranty, or responsibility of any kind, expressed or implied.

Statements of suitability for certain applications are based on KEMET Electronics Corporation's ("KEMET") knowledge of typical operating conditions for such applications, but are not intended to constitute – and KEMET specifically disclaims – any warranty concerning suitability for a specific customer application or use. The Information is intended for use only by customers who have the requisite experience and capability to determine the correct products for their application. Any technical advice inferred from this Information or otherwise provided by KEMET with reference to the use of KEMET's products is given gratis, and KEMET assumes no obligation or liability for the advice given or results obtained.

Although KEMET designs and manufactures its products to the most stringent quality and safety standards, given the current state of the art, isolated component failures may still occur. Accordingly, customer applications which require a high degree of reliability or safety should employ suitable designs or other safeguards (such as installation of protective circuitry or redundancies) in order to ensure that the failure of an electrical component does not result in a risk of personal injury or property damage.

Although all product-related warnings, cautions and notes must be observed, the customer should not assume that all safety measures are indicated or that other measures may not be required.

*KEMET is a registered trademark of KEMET Electronics Corporation.*

# Mouser Electronics

Authorized Distributor

Click to View Pricing, Inventory, Delivery & Lifecycle Information:

## KEMET:

[C4AQGBU4560P1WK](#) [C4AQGBU5100P1XK](#) [C4AQGBU5125P1YK](#) [C4AQGBU5150P11K](#) [C4AQGBU5250P12K](#)  
[C4AQGBW5400P3FK](#) [C4AQGBW5500P3JK](#) [C4AQGBW5700P3LK](#) [C4AQGBW5900P3OK](#) [C4AQGBW6100P3MK](#)  
[C4AQGBW6130P3NK](#) [C4AQGEW6170P3AK](#) [C4AQGEW6210P3BK](#) [C4AQGLU4560P11K](#) [C4AQGLU4800P12K](#)  
[C4AQGLU5150P19K](#) [C4AQGLW5120P34K](#) [C4AQGLW5160P33K](#) [C4AQGLW5360P36K](#) [C4AQGLW5450P38K](#)  
[C4AQHBU4330P1WJ](#) [C4AQHBU4560P1XJ](#) [C4AQHBU4700P1YJ](#) [C4AQHBU5100P11J](#) [C4AQHBU5150P12J](#)  
[C4AQHBW5200P3FJ](#) [C4AQHBW5300P3JJ](#) [C4AQHBW5400P3LJ](#) [C4AQHBW5500P3OJ](#) [C4AQHBW5550P3MJ](#)  
[C4AQHBW5750P3NJ](#) [C4AQHEW6110P3AJ](#) [C4AQHEW6130P3BJ](#) [C4AQHLU4330P11J](#) [C4AQHLU4500P12J](#)  
[C4AQHLU5100P19J](#) [C4AQHLW4750P34J](#) [C4AQHLW5100P33J](#) [C4AQHLW5200P36J](#) [C4AQHLW5300P38K](#)  
[C4AQJBW5150P3FJ](#) [C4AQJBW5200P3JJ](#) [C4AQJBW5300P3LJ](#) [C4AQJBW5400P3OJ](#) [C4AQJBW5450P3MJ](#)  
[C4AQJBW5550P3NJ](#) [C4AQJBW5600P3NJ](#) [C4AQJEW5850P3AJ](#) [C4AQJEW6100P3BJ](#) [C4AQJLW4580P34J](#)  
[C4AQJLW4800P33J](#) [C4AQJLW5150P36J](#) [C4AQJLW5220P38J](#) [C4AQOBU4150P1WJ](#) [C4AQOBU4270P1XJ](#)  
[C4AQOBU4330P1YJ](#) [C4AQOBU4500P11J](#) [C4AQOBU4800P12J](#) [C4AQOBW5120P3FJ](#) [C4AQOBW5140P3JJ](#)  
[C4AQOBW5200P3LJ](#) [C4AQOBW5250P3OJ](#) [C4AQOBW5300P3MJ](#) [C4AQOBW5400P3NJ](#) [C4AQOEW5550P3AJ](#)  
[C4AQOEW5650P3BJ](#) [C4AQOLU4150P11J](#) [C4AQOLU4250P12J](#) [C4AQOLU4480P19J](#) [C4AQOLW4380P34J](#)  
[C4AQOLW4500P33J](#) [C4AQOLW5100P36J](#) [C4AQOLW5140P38J](#) [C4AQQBU4100P1WJ](#) [C4AQQBU4180P1XJ](#)  
[C4AQQBU4220P1YJ](#) [C4AQQBU4330P11J](#) [C4AQQBU4500P12J](#) [C4AQQBW4800P3FJ](#) [C4AQQBW5100P3JJ](#)  
[C4AQQBW5120P3LJ](#) [C4AQQBW5180P3OJ](#) [C4AQQBW5200P3MJ](#) [C4AQQBW5250P3NJ](#) [C4AQQBW5270P3NJ](#)  
[C4AQQEW5380P3AJ](#) [C4AQQEW5450P3BJ](#) [C4AQQLU4100P11J](#) [C4AQQLU4180P12J](#) [C4AQQLU4330P19J](#)  
[C4AQQLW4260P34J](#) [C4AQQLW4350P33J](#) [C4AQQLW4750P36J](#) [C4AQQLW5100P38J](#)