



ERbic

Bus Interface Connector System

www.erni.com

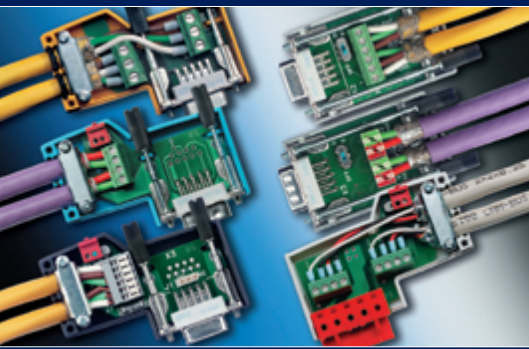



Table of Contents

ERNI bus interface connector, for short	4
General Information	4
Features	5
Applications	7
Dimensional Drawings	8
ERbic Profibus	9
ERbic Profibus Ordering Information	10
ERbic Profibus Ex i	12
ERbic Profibus Ex i Ordering Information	13
ERbic CAN Bus	14
ERbic CAN Bus Ordering Information	15
ERbic SafetyBUS p	17
ERbic SafetyBUS p Ordering Information	18
Part Number Index	19

ERbic is a trademark of the ERNI Elektroapparate GmbH, Adelberg.

General Information

The development of bus systems for industrial applications began in 1983. To be more accurate, it was the use of serial data transmission which brought about the breakthrough. In 1988, field bus systems were still new in industrial automation and a great deal of effort was required to win customers. But within a very short time, so-called field bus systems have gained acceptance to an extent that no one could have dreamed of.

This has only been possible because customers have simply been made aware of a clear product advantage. From then on, it was no longer necessary to individually wire device for device and signal for signal; instead so-called “bus nodes” could be installed, which communicate with one another by means of a 2-wire cable and pass on commands to the input and output modules. In this way, installation expense and the possibility of faults were considerably reduced. Added to this are features such as remote diagnostics, parameter setting and modularity, to name but a few. Of the multitude of field buses that came onto the market, some have almost disappeared again. The large control system manufacturers are trying to establish their systems in the marketplace through so-called user organizations, e.g. PNO (Profibus User Organization), CiA (CAN in Automation), SafetyBUS p (SafetyBUS Club), and other marketing activities.

A fundamental difference is constituted by the different network topologies. Hence, there are line, ring or star configurations. All have their particular advantages and disadvantages. Device hierarchies are also possible: master-slave systems or multi-master systems.

A characteristic of the line configuration is that the bus must be “terminated” by means of a resistor at the end of the line in order to avoid effects such as reflections, which may interfere with the communication.

Devices within the line are cabled by “looping through”. Here, the T function, which enables the bus to operate when the plug is removed, is of particular interest.

ERNI is currently concentrating on Profibus, CAN bus and SafetyBus p versions where, at the same time, customer-specific solutions e.g. for Bitbus, Interbus, etc. also exist. In the meantime, some bus systems have been internationally standardized. The so-called physical layer is also defined in these standards, which, among other things, specify the cable, the connectors and the contact assignment. There are still differences with regard to the protection class. Different plug connectors are recommended depending on this. The term “light duty” is used with IP 20 and “heavy duty” with IP 65/67.

ERNI bus interface connector, ERbic for short

The interface plugs of the ERbic line for various bus systems offer different features and advantages. They are based on D-Sub interface technology. All ERbics have compact external dimensions. There are versions with horizontal and vertical cable outlets.

Both pure node versions and pure termination versions are available as well as nodes with a connectable termination resistor. The node (without termination resistors) is used within the length of a line and the termination (with termination resistors) at the end of the line. The node with a connectable termination resistor can be used anywhere. The latter is simply configured as a termination by changing the position of the switch.

The housings of the pure terminations are a different color than the nodes. The end of the line is therefore immediately recognizable.

The bus systems are also different colors. The user can therefore easily find their way around within a system.

A T function is provided in all ERbics. A device can therefore be changed while the bus is running. The types with a connectable termination resistor are primarily suitable for customers with reduced storage or when setting up, extending or converting large systems.

Certain types are reversed with regard to the face of the connector, allowing the direction of the cable outlet to be determined. This is achieved by a special pin arrangement in the D-Sub connector.

However, the standard direction of the cable outlet is matched to the devices of the market leaders and should therefore be used for new designs.

A further outstanding feature is the termination technology. Depending upon the type, ERbics are available with screw terminals, cage-clamp terminals or IDC terminals.

Terminations using the Siemens FastConnect principle, for example, are therefore possible.

The development of field buses in the direction of safety-related applications is also satisfied by corresponding further advancement of the ERbic line. There is a Profibus Ex i version, which was developed together with ABB, or a SafetyBus p version for the Pilz company.

As an alternative to the plastic housing, the newly developed ERbic MAX has recently been introduced to the market. This has a metal housing and an axial cable outlet. It is particularly suitable for harsh environments and offers space advantages at the field device when several interfaces are present.

The metal housing guarantees optimum EMC.

Features



Common ERbic design for different bus systems. Versions for Profibus, CAN bus and SafetyBus p. Different colors among buses.

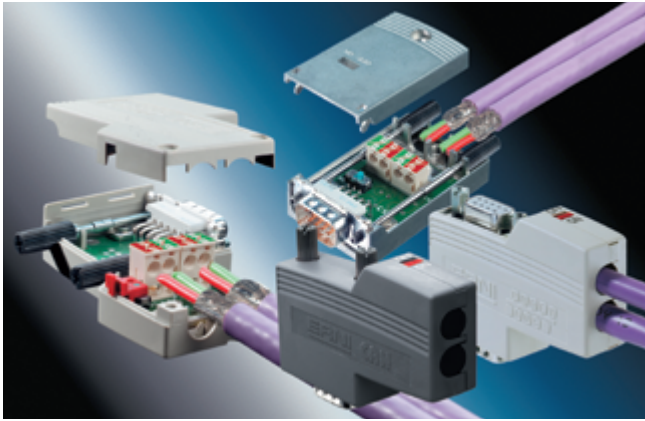

Node with connectable termination resistor

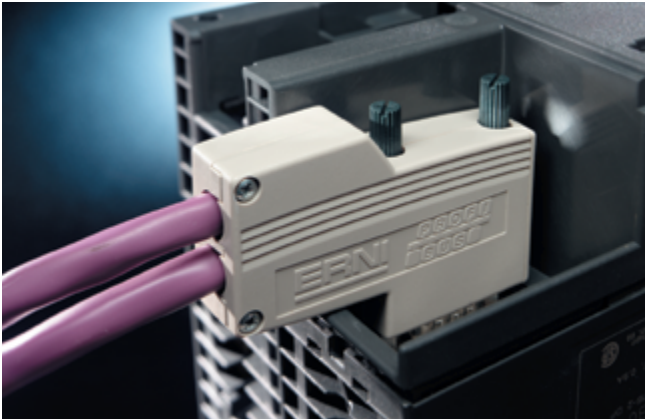

Integral T function, bus in, bus out



Support for max. data rates, e.g. Profibus, 12 Mbit/s through integral inductances

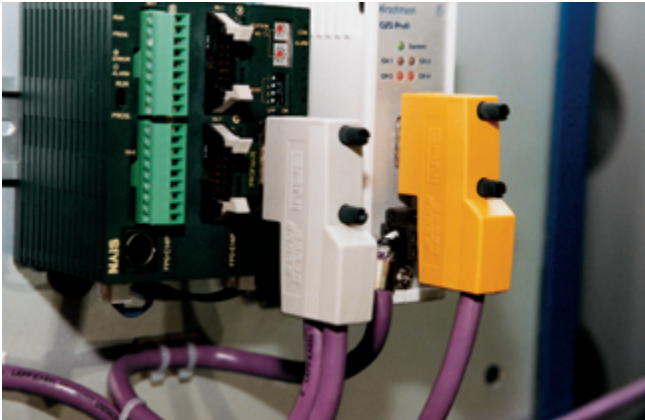

Pure nodes and termination versions. Color differentiation between node and termination within the bus

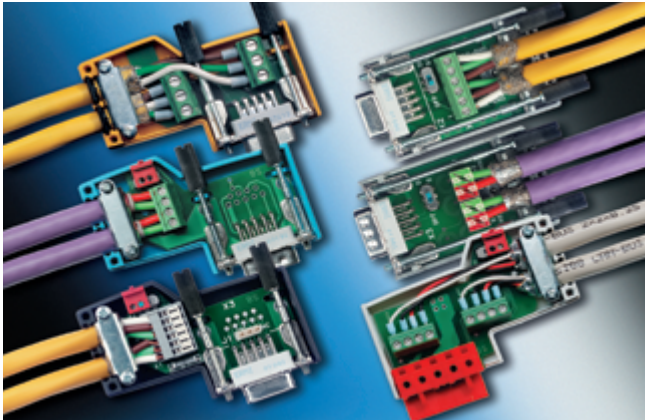

Flexibility through different termination technologies

Features



Full metal version for particularly severe loading



Reversed version for determining the cable outlet direction



Horizontal or vertical cable outlet



Versions with second D-Sub as service interface and externally connectable termination resistor

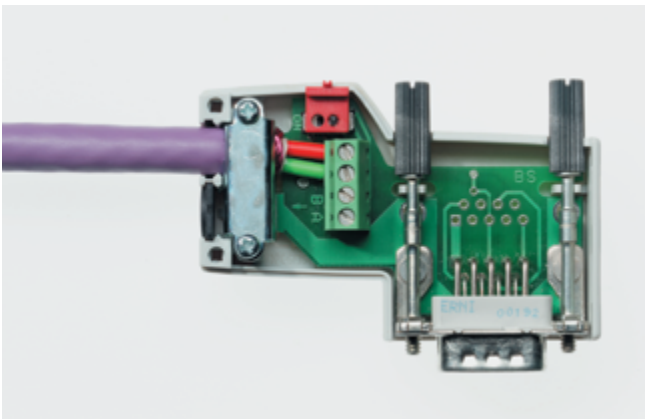

Reliable cable strain relief with shield connection



Special versions on request

Applications

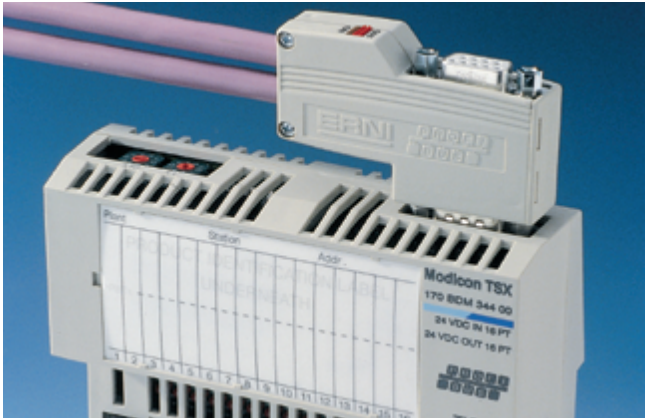
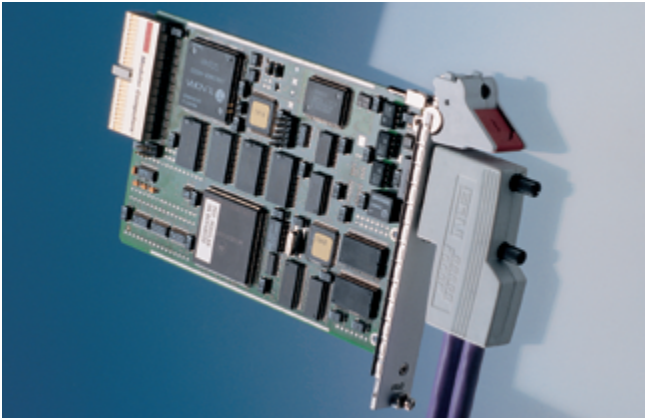
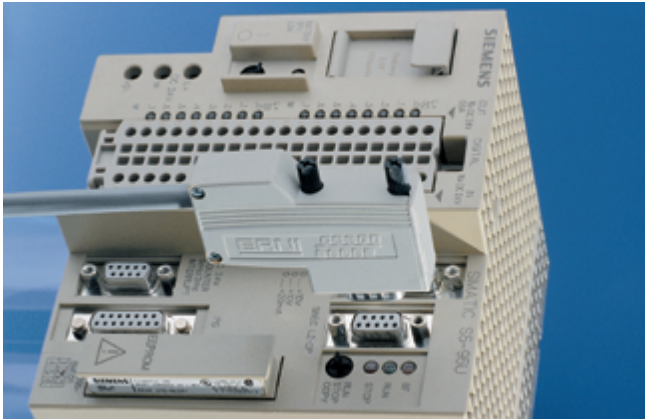

Dimensional Drawings

ERbic

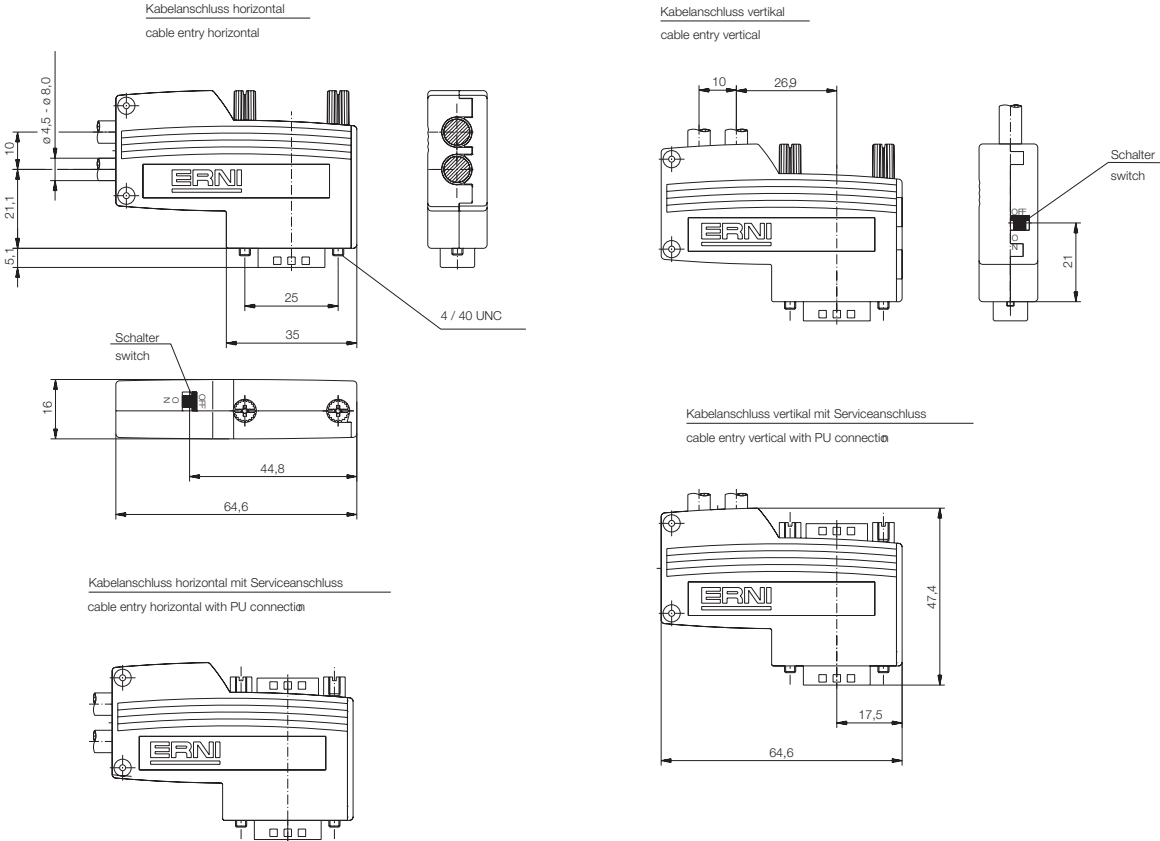

ERbic MAX

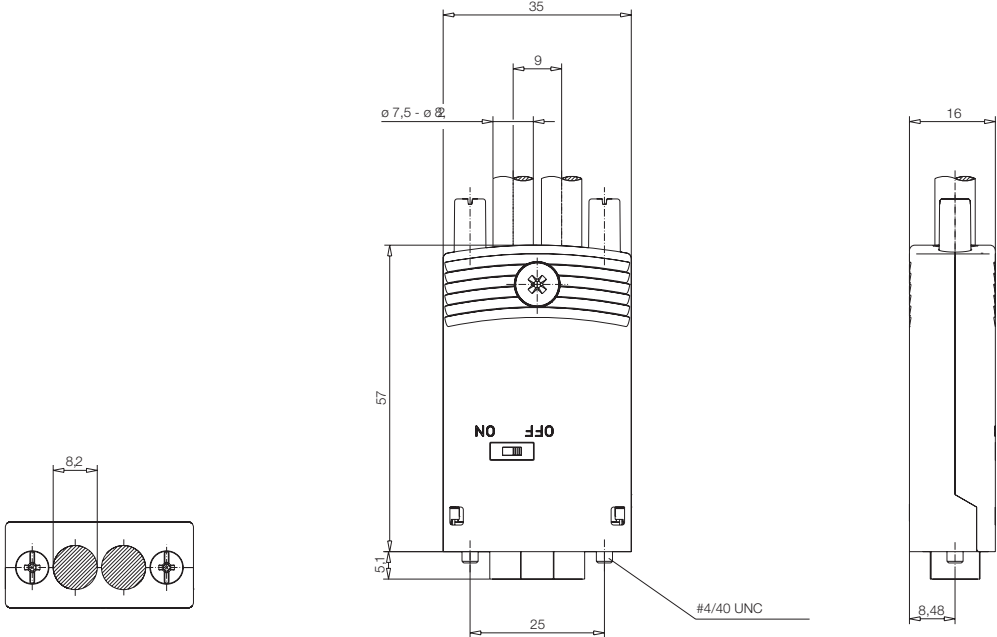

ERbic Profibus



Profibus is the most widely used field bus. It is promoted by Siemens and by organized, interested and committed manufacturers and users in the PNO (Profibus user organization). The IP 20 interface on the device side is standardized as a 9-pin D-Sub female connector. The max. data transmission rate is 12 Mbit/s. The cable is a shielded twisted pair conductor.

The cable sheath is violet and the signal cores are green (A) and red (B).

With its comprehensive program, ERNI provides customers with a wide variety of options.

Particular emphasis should be placed on the different termination technologies, from the traditional screw terminal to the cage clamp terminal to the IDC terminal.*

Electrical and mechanical characteristics

Interface connector
D-Sub male or female (PU connection)
D-Sub male reversed version
Cable termination

Cable diameter
Cross section of individual conductor

Termination type
Data transmission rate
Temperature range
Permissible humidity
Protection class
Housing material
D-Sub screw
UL approval
CE marking

D-Sub, 9-pin, male
Class 2
Class 3
2 x horizontal, 2 x vertical, MAX: 2 x axial
1 cable outlet can be sealed with blanking plate
4.5 mm (0.177") – 8.0 mm (0.315")
Screw terminal: solid max. 1.5 mm²; stranded max. 1.0 mm²
IDC terminal: solid \varnothing 0.64 mm
Cage-clamp terminal: 0.08 - 0.5 mm² (0.75 mm²)
Screw terminal, IDC terminal, cage-clamp terminal
According to bus specification, 12 MBit/s
-20 °C – +70 °C
Max. 75 % at + 25 °C, non-condensing
IP 40, MAX: IP 30
Thermoplast UL94V-1, MAX: ZnAl, galvanized
#4/40 UNC, knurled with cross-head
UL E84703 *

ERbic connectors are passive components and do not need to be identified with the CE marking according to EU directives.

* Due to continuous advancement, it is possible that the UL approval of a new version may not have been completed at the time of going to press.

Pin configuration

Terminal	D-Sub Pin	Signal
B (1)	3	RxD/TxD-P
A (2)	8	RxD/TxD-N
B (3)	3	RxD/TxD-P
A (4)	8	RxD/TxD-N
-	5	GND
-	6	VP (+5V)



ERbic Profibus

Ordering Information

ERbic Type	Color	Cable outlet	D-Sub 9-pin	Screw	Preferred ¹⁾	Part Number
Profibus with external switch and IDC terminal						
Profibus Standard	slat gray	horizontal	Male	#4/40 UNC	Yes	144037
Profibus reversed	slat gray	horizontal	Male	#4/40 UNC	Yes	144176
Profibus with service/PU connection	slat gray	horizontal	Male and Female (PU connection)	#4/40 UNC	Yes	144536
Profibus with service/PU connection, reversed	slat gray	horizontal	Male and Female (PU connection)	#4/40 UNC	Yes	154842
Profibus Standard	slat gray	vertical	Male	#4/40 UNC	Yes	134278
Profibus with service/PU connection	slat gray	vertical	Male and Female (PU connection)	#4/40 UNC	Yes	154825
Profibus with external switch and cage clamp						
Profibus Standard	slat gray	horizontal	Male	#4/40 UNC	Yes	174048
Profibus with service/PU connection	slat gray	horizontal	Male	#4/40 UNC	Yes	174049
Profibus with external switch, IDC terminal and metal housing						
Profibus MAX Standard	silver	axial	Male	#4/40 UNC	Yes	134928
Profibus with external switch and screw terminal						
Profibus Standard	slat gray	horizontal	Male	#4/40 UNC	Yes	134728
Profibus with service/PU connection	slat gray	horizontal	Male and Female (PU connection)	#4/40 UNC	Yes	144475



ERbic Profibus

Ordering Information

ERbic Type	Color	Cable outlet	D-Sub 9-pin	Screw	Preferred ¹⁾	Part Number
Profibus node with screw terminal						
Profibus Standard	slat gray	horizontal	Male	#4/40 UNC	Yes	103648
Profibus reversed	slat gray	horizontal	Male	#4/40 UNC		104577
Profibus with service/PU connection	slat gray	horizontal	Male and Female (PU connection)	#4/40 UNC	Yes	103663
Profibus Standard	slat gray	vertical	Male	#4/40 UNC	Yes	103658
Profibus reversed	slat gray	vertical	Male	#4/40 UNC		114592
Profibus termination with screw terminal						
Profibus Standard	yellow	horizontal	Male	#4/40 UNC	Yes	103649
Profibus reversed	yellow	horizontal	Male	#4/40 UNC		104322
Profibus with service/PU connection	yellow	horizontal	Male and Female (PU connection)	#4/40 UNC	Yes	104329
Profibus Standard	yellow	vertical	Male	#4/40 UNC	Yes	103659

Packaging: Single box with enclosed assembly instructions.

1) Preferred types are generally available from stock.

ERbic Profibus Ex i



There is a special Profibus specification for safety-orientated intrinsically safe applications. Intrinsic safety is achieved by limiting the energy. At low voltage, this is reflected, among other things, by a higher current density in the bus line, as the devices are also supplied with power via the bus line. With regard to the connector, the main factor is compliance with EN 50020. For example, defined clearance and creepage distances and current carrying capacity must be taken into account. These Ex i connectors have been developed in cooperation with ABB and approved for their S900 controller. The individual connector alone does not require separate approval. This must always be given in conjunction with the system in accordance with the relevant directives and standards.

Electrical and mechanical characteristics

Interface connector
D-Sub male
Cable termination

Cable diameter
Cross section of individual conductor
Termination type
Data transmission rate
Temperature range
Permissible humidity
Protection class
Housing material
D-Sub screw
UL approval
CE marking

D-Sub, 9-pin, male
Class 2
2 x horizontal
1 cable outlet can be sealed with blanking plate
4.5 mm (0.177") – 8.0 mm (0.315")
Screw terminal: solid max. 1.5 mm²; stranded max. 1.0 mm²
Screw terminal
According to bus specification, 12 MBit/s
-20 °C – +70 °C
Max. 75 % at + 25 °C, non-condensing
IP 40
Thermoplast UL94V-1
#4/40 UNC, knurled with cross-head
UL E84703 *
ERbic connectors are passive components and do not need to be identified with the CE marking according to EU directives.

* Due to continuous advancement, it is possible that the UL approval of a new version may not have been completed at the time of going to press.

Pin configuration

Terminal	D-Sub Pin	Signal
B (1)	3	RxD/TxD-P
A (2)	8	RxD/TxD-N
B (3)	3	RxD/TxD-P
A (4)	8	RxD/TxD-N
-	5	GND
-	6	VP (+5V)



ERbic Profibus Ex i

Ordering Information

ERbic Type	Color	Cable outlet	D-Sub 9-pin	Screw	Preferred ¹⁾	Part Number
Profibus Ex i with external switch and screw terminal						
Profibus Ex i Standard	blue	horizontal	Male	#4/40 UNC	Yes	134727

Packaging: Single box with enclosed assembly instructions.

1) Preferred types are generally available from stock.

ERbic CAN Bus



The CAN bus, originally developed for automobile engine management, is distinguished by its particularly high reliability. Among other things, this necessitates a more complicated protocol, which leads to lower data rates and cable lengths. This can be compensated for in part by larger cable cross sections. Data rates reach 1 Mbit/s. The 9-pin D-Sub connector is standardized as the interface to the device. In some cases, a version with a shield coupling capacitor is available as an option (cable shield <-> housing D-Sub).

Electrical and mechanical characteristics

Interface connector
D-Sub female or male (PU connection)
D-Sub female reversed version
Cable termination

Cable diameter
Cross section of individual conductor

Termination type
Data transmission rate
Temperature range
Permissible humidity
Protection class
Housing material
D-Sub screw
UL approval
CE marking

D-Sub, 9-pin, female
Class 2
Class 3
2 x horizontal, 2 x vertical, MAX: 2 x axial
1 cable outlet can be sealed with blanking plate
4.5 mm (0.177") – 8.0 mm (0.315")
Screw terminal: 0.14 – 0.5 mm²; HLG: 1.5 mm²
MAX: 0.14 – 1 mm² (HLG)
Cage-clamp terminal: 0.08 – 0.5 mm² (0.75 mm²) (HLG)
Screw terminal, cage-clamp terminal
According to CAN specification, max. 1 Mbit/s
-20 °C – +70 °C
Max. 75 % at +25 °C, non-condensing
IP 40 MAX: IP 30
Thermoplast UL94V-1 MAX: ZnAl, galvanized
#4/40 UNC, knurled with cross-head
UL E84703 *
ERbic connectors are passive components and do not need to be identified with the CE marking according to EU directives.

* Due to continuous advancement, it is possible that the UL approval of a new version may not have been completed at the time of going to press.

Pin configuration (HLG-Version)

Terminal	D-Sub Pin	Signal
1,6	3	CAN-GND
2,4	2	CAN-L
3,5	7	CAN-H
-	5	CAN-SHLD

Pin configuration (no HLG-Version)

Terminal	D-Sub	Signal
1,9	9	V+
2,10	6	V+ GND
3,8	3	CAN-GND
4,6	2	CAN-L
5,7	7	CAN-H
-	5	CAN-SHLD

ERbic CAN Bus

Ordering Information

ERbic Type	Color	Cable outlet	D-Sub 9-pin	Screw	Preferred ¹⁾	Part Number
CAN Bus with external switch and cage clamp						
CAN Bus with shield decoupling capacitor HLG*	anthracit	horizontal	Female	#4/40 UNC	yes	144744
CAN Bus with shield decoupling capacitor and service/PU connection HLG*	anthracit	horizontal	Female and Male (PU connection)	#4/40 UNC	yes	154826
CAN Bus with external switch and screw terminal						
CAN Bus Standard HLG*	anthracit	vertical	Female	#4/40 UNC	yes	154824
CAN Bus with external switch, screw terminal and metal housing						
CAN Bus MAX Standard HLG*	silver	axial	Female	#4/40 UNC	yes	154039
CAN Bus node with screw terminal						
CAN Bus Standard	anthracit	horizontal	Female	#4/40 UNC	yes	103668
CAN Bus with service/PU connection	anthracit	horizontal	Female and Male (PU connection)	#4/40 UNC		134149
CAN Bus with shield decoupling capacitor	anthracit	horizontal	Female	#4/40 UNC		103642
CAN Bus with shield decoupling capacitor, reversed	anthracit	horizontal	Female	#4/40 UNC		104320
CAN Bus with shield decoupling capacitor HLG*	anthracit	horizontal	Female	#4/40 UNC	yes	124620
CAN Bus with shield decoupling capacitor HLG*, reversed	anthracit	horizontal	Female	#4/40 UNC	yes	124654
CAN Bus Standard	anthracit	vertical	Female	#4/40 UNC		103669
CAN Bus with shield decoupling capacitor and service/PU connection	anthracit	horizontal	Female and Male (PU connection)	#4/40 UNC		103662
CAN Bus with shield decoupling capacitor	anthracit	vertical	Female	#4/40 UNC	yes	103652



ERbic Profibus

Ordering Information

ERbic Type	Color	Cable outlet	D-Sub 9-pin	Screw	Preferred ¹⁾	Part Number
CAN Bus termination with screw terminal						
CAN Bus Standard	green	horizontal	Female	#4/40 UNC	yes	103643
CAN Bus with service/ PU connection	green	horizontal	Female and Male (PU connection)	#4/40 UNC		104670
CAN Bus with shield decoupling capacitor	green	horizontal	Female	#4/40 UNC		103644
CAN Bus with shield decoupling capacitor, reversed	green	horizontal	Female	#4/40 UNC		104321
CAN Bus with shield decoupling capacitor HLG*	green	horizontal	Female	#4/40 UNC	yes	124621
CAN Bus with shield decoupling capacitor HLG*, reversed	green	horizontal	Female	#4/40 UNC		124655
CAN Bus Standard	green	vertical	Female	#4/40 UNC	yes	103653

*HLG, only CAN High, CAN Low and CAN Ground can be connected.

Packaging: Single box with enclosed assembly instructions.

1) Preferred types are generally available from stock.

ERbic SafetyBUS p



The SafetyBUS p utilizes the advantages of the CAN bus. A protocol has been developed by Pilz that satisfies safety engineering requirements.

A larger cable cross section of 0.75 mm² is specified to cover longer distances. Only the 3 conductors necessary for the bus are terminated within the connector (HLG).

Electrical and mechanical characteristics

Interface connector
D-Sub female
Cable termination

Cable diameter
Cross section of individual conductor
Termination type
Data transmission rate
Temperature range
Permissible humidity
Protection class
Housing material
D-Sub screw
UL approval
CE marking

D-Sub, 9-pin, female
Class 2
2 x horizontal
1 cable outlet can be sealed with blanking plate
4.5 mm (0.177") – 8.0 mm (0.315")
Max. 1.5 mm²
Screw terminal
According to CAN specification, max. 1 Mbit/s
-20 °C – +70 °C
Max. 75 % at +25 °C, non-condensing
IP 40
Thermoplast UL94V-1
#4/40 UNC, knurled with cross-head
UL E84703 *
ERbic connectors are passive components and do not need to be identified with the CE marking according to EU directives.

* Due to continuous advancement, it is possible that the UL approval of a new version may not have been completed at the time of going to press.

Pin configuration (HLG-Version)

Terminal	D-Sub Pin	Signal
1	3	CAN-GND
2	2	CAN-L
3	7	CAN-H
-	5	CAN-SHLD



ERbic SafetyBUS p

Ordering Information

ERbic Type	Color	Cable outlet	D-Sub 9-pin	Screw	Preferred ¹⁾	Part Number
SafetyBUS p with screw terminal						
SafetyBUS p node/termination HLG	yellow	horizontal	Female	#4/40 UNC	yes	114542

*Termination resistor is supplied and is connected across the terminals of the outgoing conductor. HLG, only CAN High, CAN Low and CAN Ground can be connected.

Packaging: Single box with enclosed assembly instructions.

1) Preferred types are generally available from stock.



Part Number Index

Part Number	Page
103642	15
103643	16
103644	16
103648	11
103649	11
103652	15
103653	16
103658	11
103659	11
103662	15
103663	11
103668	15
103669	15
104320	15
104321	16
104322	11
104329	11
104577	11
104670	16
114542	18
114592	11
124620	15
124621	16
124654	15
124655	16
134149	15
134278	10
134727	13
134728	10
134928	10
144037	10
144176	10
144475	10
144536	10
144744	15
154039	15
154824	15
154825	10
154826	15
154842	10
174048	10
174049	10



Member



VMEbus INTERNATIONAL TRADE ASSOCIATION



ERNI Electronics GmbH & Co. KG

Japan
Seestrasse 9
73099 Adelberg / Germany
Tel +49 7166 50-0
Fax +49 7166 50-282
info@erni.de

Europe South America Africa

ERNI Electronics, Inc.

2201 Westwood Ave
Richmond, VA 23230 / USA
Tel +1 804 228-4100
Fax +1 804 228-4099
info@erni.us

North America Canada Mexico

ERNI Asia Holding Pte Ltd.

Blk 4008 Ang Mo Kio Avenue 10
#04-01/02 Techplace I
Singapore 569625
Tel +65 6 555 5885
Fax +65 6 555 5995
info@erni-asia.com

Asia Australia New Zealand

www.erni.com

© ERNI Electronics GmbH & Co. KG 2006 • Printed in Germany. A policy of continuous improvement is followed and the right to alter any published data without notice is reserved. ERNI[®], MicroStac[®], MicroSpeed[®], MiniBridge[®], MicroCon[®], MaxiBridge[®], ERmet[®], ERmet ZD[®], ERbic[®], ERNIPRESS[®], INTERact[®], WHITEspeed[®], BLUEcontact[®], Act. Connect. Perfect.[®] and ERNI WoR&D[®] are trademarks (registered or applied for in various countries) of ERNI Electronics GmbH & Co. KG.