

CE DOCUMENT EST LA PROPRIETE D'Amphenol Socapex. IL NE PEUT ETRE NI REPRODUIT, NI COMMUNIQUE A DES TIERS SANS AUTORISATION ECRITE
[IMP 004 C]

CODAGE INSERTS

VUES COTE ENFICHAGE

INSERTS CODING

CONNECTION SIDE VIEW

FICHE
PLUG

EMBASE
RECEPTACLE

GRANDE CLE
MAIN KEY

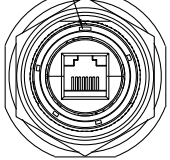
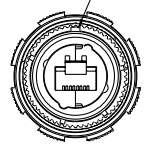

CODE A

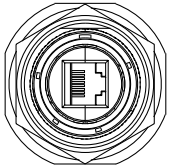

CODE B

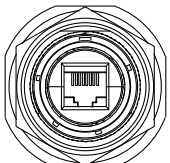

CODE C

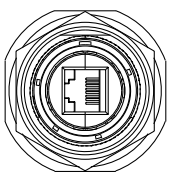
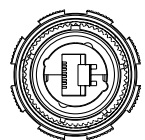

CODE D

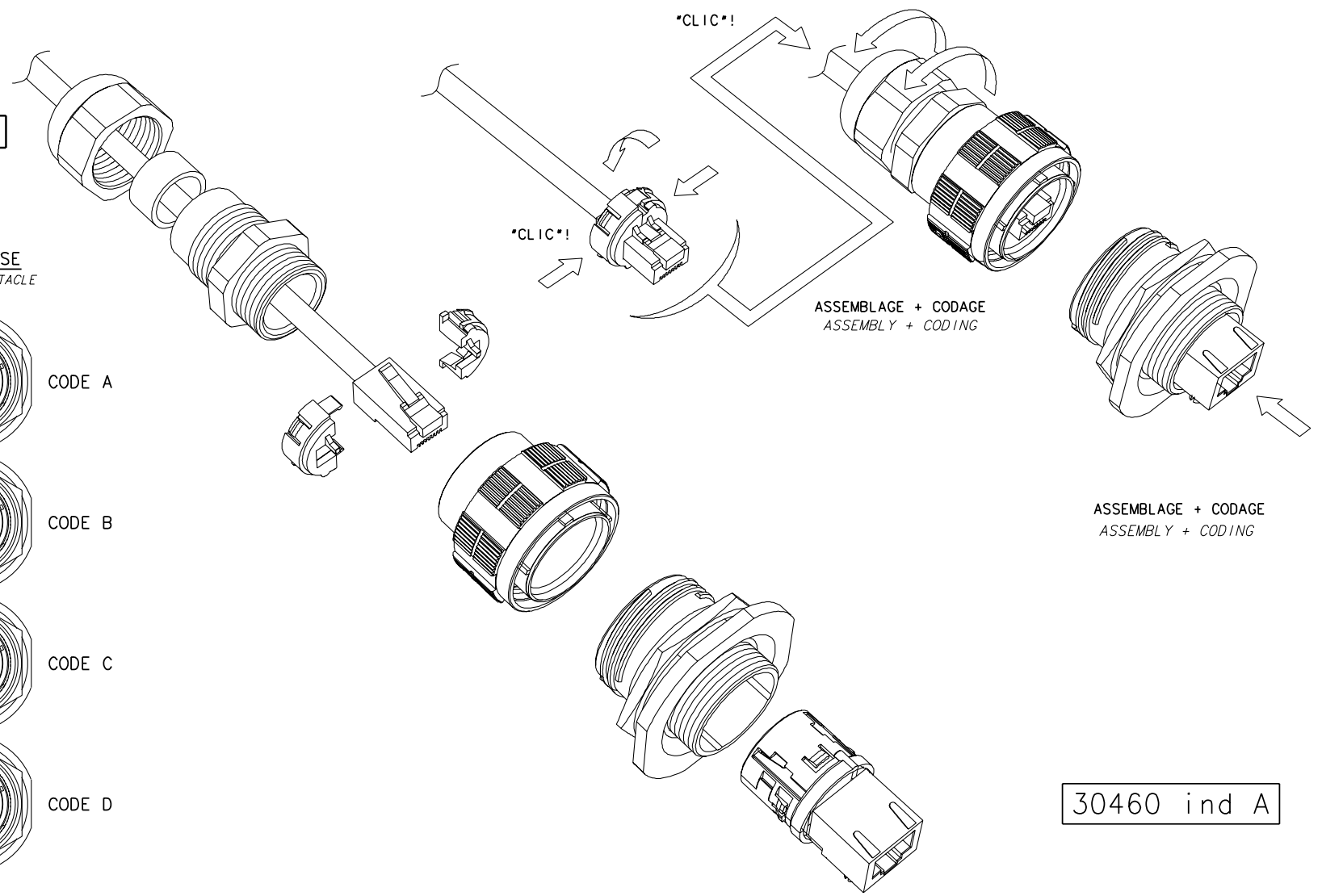

ASSEMBLAGE + CODAGE
ASSEMBLY + CODING

ASSEMBLAGE + CODAGE
ASSEMBLY + CODING

30460 ind A

REDUIRE LA NOTICE DE 50% PUIS DECOUPER



ECHELLES 1	TOLERANCES GENERALES			DESSINE PAR:	VISA	TECHNIQUE:	LE:
	ALESAGES JS 13	ARBRES js 13	ANGLES ±2°	TUPIN 28/03/02			
NOTICE D'UTILISATION CONNECTEURS RJField						Amphenol Socapex	
						REPLACE LE: -	IND.: -
						INDICE: → A	
3D: DEV 190-N015						190-N015-E001 1/1	

MOD IF	MOD	NUMERO	DATE			
	A	Plan original	28/03/02			