



FEATURES

- CYLINDRICAL V-CHIP CONSTRUCTION FOR SURFACE MOUNTING
- VERY LOW IMPEDANCE & HIGH RIPPLE CURRENT AT 100KHz
- SUITABLE FOR DC-DC CONVERTER, DC-AC INVERTER, ETC.
- NEW EXPANDED CV RANGE, UP TO 6800µF
- NEW HIGH TEMPERATURE REFLOW "M1" VERSION
- DESIGNED FOR AUTOMATIC MOUNTING AND REFLOW SOLDERING
- **MEETS THE REQUIREMENTS OF AEC-Q200***

See **NAZT** for
New Designs

**RoHS
Compliant**

includes all homogeneous materials



*Contact NIC for supporting test data

*See Part Number System for Details

CHARACTERISTICS

Rated Voltage Rating	6.3 ~ 50Vdc							
Rated Capacitance Range	4.7 ~ 6800µF							
Operating Temp. Range	-55 ~ +105°C							
Capacitance Tolerance	±20% (M)							
Max. Leakage Current After 2 Minutes @ 20°C	0.01CV Or 3µA, whichever is greater							
Tan δ @ 120Hz/20°C	W.V. (Vdc)	6.3	10	16	25	35	50	
	S.V. (Vdc)	8.0	13	20	32	44	63	
	φ4 ~ φ6.3mm Dia.	0.24	0.20	0.16	0.14	0.12	0.10	
	φ8 ~ φ16mm Dia.	C ≤ 1000µF	0.28	0.24	0.20	0.16	0.14	0.14
		C = 1500µF	0.29	0.25	0.21	-	0.14	-
		C = 2200µF	0.30	0.26	-	0.18	-	-
C = 3300µF		0.32	-	0.24	-	-	-	
C = 4700µF		0.34	0.30	-	-	-	-	
	C = 6800µF	0.38	-	-	-	-	-	
Low Temperature Stability Impedance Ratio @ 120Hz	W.V. (Vdc)	6.3	10	16	25	35	50	
	Z-40°C/Z+20°C	3	2	2	2	2	2	
	Z-55°C/Z+20°C	5	4	4	3	3	3	
Load Life Test @ 105°C 4 ~ 6mm Dia., 10x8mm 1,000 hours 8 ~ 12.5mm Dia. 2,000 hours	Capacitance Change	Within ±25% of initial measured value						
	Tan δ	Less than ±200% of the specified maximum value						
	Leakage Current	Less than the specified maximum value						

**LOW IMPEDANCE
AT HIGH FREQUENCY**
INDUSTRY STANDARD
STYLE FOR SWITCHERS
AND CONVERTERS

**LOW ESR COMPONENT
LIQUID ELECTROLYTE**
For Performance Data
see www.LowESR.com

STANDARD PRODUCT AND CASE SIZE TABLE Dφ x L (mm)

Cap (µF)	Code	Working Voltage (Vdc)					
		6.3	10	16	25	35	50
4.7	4R7	-	-	-	-	4x6.3	4x6.3
10	100	-	-	-	4x6.3*	5x6.3*	6.3x6.3*
15	150	-	-	4x6.3	5x6.3	5x6.3*	-
22	220	-	4x6.3	5x6.3*	5x6.3	5x6.3*	6.3x6.3*
27	270	4x6.3*	-	-	-	-	-
33	330	-	5x6.3	-	6.3x6.3	6.3x6.3*	6.3x8*
47	470	5x6.3	-	6.3x6.3	6.3x6.3	6.3x6.3*	6.3x8*
56	560	5x6.3*	-	-	6.3x6.3	-	-
68	680	-	6.3x6.3	6.3x6.3*	6.3x6.3	6.3x8*	8x10.5*
100	101	6.3x6.3*	-	6.3x6.3*	6.3x8*	8x10.5	8x10.5*
120	121	-	6.3x6.3	-	-	-	-
150	151	6.3x6.3	6.3x6.3	6.3x8*	8x10.5*	8x10.5*	10x10.5*
						10x8	
220	221	6.3x6.3	6.3x8	6.3x8*	8x10.5*	8x10.5	10x10.5
					10x8		
330	331	6.3x8*	8x10.5	8x10.5*	8x10.5	10x10.5	12.5x14
				10x8			
390	391	-	-	-	-	-	12.5x14
470	471	8x10.5	8x10.5	8x10.5	10x10.5*	12.5x14	16x17
			10x8				
680	681	8x10.5	-	10x10.5	-	12.5x14	-
		10x8*					
820	821	-	10x10.5	-	-	-	-
1000	102	8x10.5*	10x10.5	-	12.5x14	-	16x17
1500	152	10x10.5*	-	12.5x14	-	16x17	-
2200	222	-	12.5x14	-	16x17	-	-
3300	332	12.5x14	-	16x17	-	-	-
4700	472	-	16x17	-	-	-	-
6800	682	16x17	-	-	-	-	-

NACZ Series
Surface Mount Aluminum Electrolytic Capacitors



STANDARD VALUES, CASE SIZES AND SPECIFICATIONS

NIC Part Number*	Cap. (µF)	W.V. (Vdc)	Dissipation Factor (Tan δ)	Max. Ripple Current (mA) +105°C, 100KHz	Max. Impedance (Ω) +20°C, 100KHz	Load Life Hours @ +105°C
NACZ270M6.3V4X6.3TR_F	27	6.3	0.24	80	1.80	1,000
NACZ470M6.3V5X6.3TR_F	47		0.24	150	0.76	1,000
NACZ560M6.3V5X6.3TR_F	56		0.24	150	0.76	1,000
NACZ101M6.3V6.3X6.3TR_F	100		0.24	230	0.44	1,000
NACZ151M6.3V6.3X6.3TR_F	150		0.24	230	0.44	1,000
NACZ221M6.3V6.3X6.3TR_F	220		0.24	230	0.44	1,000
NACZ331M6.3V6.3X8TR_F	330		0.24	280	0.34	1,000
NACZ471M6.3V8X10.5TR_F	470		0.28	450	0.17	2,000
NACZ681M6.3V8X10.5TR_F	680		0.28	450	0.17	2,000
NACZ681M6.3V10X8TR_F						1,000
NACZ102M6.3V8X10.5TR_F	1000		0.28	450	0.17	2,000
NACZ152M6.3V10X10.5TR_F	1500		0.29	670	0.09	2,000
NACZ332M6.3V12.5X14TR_F	3300		0.32	900	0.066	2,000
NACZ682M6.3V16X17TR_F	6800		0.38	1250	0.052	2,000
NACZ220M10V4X6.3TR_F	22	10	0.20	80	1.80	1,000
NACZ330M10V5X6.3TR_F	33		0.20	150	0.76	1,000
NACZ680M10V6.3X6.3TR_F	68		0.20	230	0.44	1,000
NACZ121M10V6.3X6.3TR_F	120		0.20	230	0.44	1,000
NACZ151M10V6.3X6.3TR_F	150		0.20	230	0.44	1,000
NACZ221M10V6.3X8TR_F	220		0.20	280	0.34	1,000
NACZ331M10V8X10.5TR_F	330		0.24	450	0.17	2,000
NACZ471M10V8X10.5TR_F	470		0.24	450	0.17	2,000
NACZ471M10V10X8TR_F						1,000
NACZ821M10V10X10.5TR_F	820		0.24	670	0.09	2,000
NACZ102M10V10X10.5TR_F	1000		0.24	670	0.09	2,000
NACZ222M10V12.5X14TR_F	2200		0.26	900	0.066	2,000
NACZ472M10V16X17TR_F	4700		0.30	1250	0.052	2,000
NACZ150M16V4X6.3TR_F	15		16	0.16	80	1.80
NACZ220M16V5X6.3TR_F	22	0.16		150	0.76	1,000
NACZ470M16V6.3X6.3TR_F	47	0.16		230	0.44	1,000
NACZ680M16V6.3X6.3TR_F	68	0.16		230	0.44	1,000
NACZ101M16V6.3X6.3TR_F	100	0.16		230	0.44	1,000
NACZ151M16V6.3X8TR_F	150	0.16		280	0.34	1,000
NACZ221M16V6.3X8TR_F	220	0.16		280	0.34	1,000
NACZ331M16V8X10.5TR_F	330	0.20		450	0.17	2,000
NACZ331M16V10X8TR_F						1,000
NACZ471M16V8X10.5TR_F	470	0.20		450	0.17	2,000
NACZ681M16V10X10.5TR_F	680	0.20		670	0.09	2,000
NACZ152M16V12.5X14TR_F	1500	0.21		900	0.066	2,000
NACZ332M16V16X17TR_F	3300	0.24		1250	0.052	2,000
NACZ100M25V4X6.3TR_F	10	25		0.14	80	1.80
NACZ150M25V5X6.3TR_F	15		0.14	150	0.76	1,000
NACZ220M25V5X6.3TR_F	22		0.14	150	0.76	1,000
NACZ330M25V6.3X6.3TR_F	33		0.14	230	0.44	1,000
NACZ470M25V6.3X6.3TR_F	47		0.14	230	0.44	1,000
NACZ560M25V6.3X6.3TR_F	56		0.14	230	0.44	1,000
NACZ680M25V6.3X6.3TR_F	68		0.14	230	0.44	1,000
NACZ101M25V6.3X8TR_F	100		0.14	280	0.34	1,000
NACZ151M25V8X10.5TR_F	150		0.16	450	0.17	2,000
NACZ221M25V8X10.5TR_F	220		0.16	450	0.17	2,000
NACZ221M25V10X8TR_F						1,000
NACZ331M25V8X10.5TR_F	330		0.16	450	0.17	2,000
NACZ471M25V10X10.5TR_F	470		0.16	670	0.09	2,000
NACZ102M25V12.5X14TR_F	1000		0.16	900	0.066	2,000
NACZ222M25V16X17TR_F	2200	0.18	1250	0.052	2,000	
NACZ4R7M35V4X6.3TR_F	4.7	35	0.12	80	1.80	1,000
NACZ100M35V5X6.3TR_F	10		0.12	150	0.76	1,000
NACZ150M35V5X6.3TR_F	15		0.12	150	0.76	1,000
NACZ220M35V5X6.3TR_F	22		0.12	150	0.76	1,000
NACZ330M35V6.3X6.3TR_F	33		0.12	230	0.44	1,000
NACZ470M35V6.3X6.3TR_F	47		0.12	230	0.44	1,000

*For Automotive Equipment and high temperature reflow version see part number system

Performance Passives By Design

NIC Components Corp.
100 Baylis Road, Melville, NY 11747



STANDARD VALUES, CASE SIZES AND SPECIFICATIONS

NIC Part Number*	Cap. (μF)	W.V. (Vdc)	Dissipation Factor (Tan δ)	Max. Ripple Current (mA) +105°C, 100KHz	Max. Impedance (Ω) +20°C, 100KHz	Load Life Hours @ +105°C
NACZ680M35V6.3X8TR_F	68	35	0.12	280	0.34	1,000
NACZ101M35V8X10.5TR_F	100		0.14	450	0.17	2,000
NACZ151M35V8X10.5TR_F	150		0.14	450	0.17	2,000
NACZ151M35V10X8TR_F						1,000
NACZ221M35V8X10.5TR_F	220		0.14	450	0.17	2,000
NACZ331M35V10X10.5TR_F	330		0.14	670	0.09	2,000
NACZ471M35V12.5X14TR_F	470		0.14	900	0.066	2,000
NACZ681M35V12.5X14TR_F	680		0.14	900	0.066	2,000
NACZ152M35V16X17TR_F	1500	0.14	1250	0.052	2,000	
NACZ4R7M50V4X6.3TR_F	4.7	50	0.10	60	2.90	1,000
NACZ100M50V6.3X6.3TR_F	10		0.10	165	0.88	1,000
NACZ220M50V6.3X6.3TR_F	22		0.10	165	0.88	1,000
NACZ330M50V6.3X8TR_F	33		0.10	195	0.75	1,000
NACZ470M50V6.3X8TR_F	47		0.10	195	0.75	1,000
NACZ680M50V8X10.5TR_F	68		0.14	300	0.40	2,000
NACZ101M50V8X10.5TR_F	100		0.14	300	0.40	2,000
NACZ151M50V10X10.5TR_F	150		0.14	450	0.22	2,000
NACZ221M50V10X10.5TR_F	220		0.14	450	0.22	2,000
NACZ331M50V12.5X14TR_F	330		0.14	620	0.14	2,000
NACZ391M50V12.5X14TR_F	390		0.14	620	0.14	2,000
NACZ471M50V16X17TR_F	470		0.14	790	0.078	2,000
NACZ102M50V16X17TR_F	1000		0.14	790	0.078	2,000

Part Number Suffix Where __: Preferred (15" reel) = 15, Legacy (13" reel) = 13 (check with NIC for availability)

*For Automotive Equipment and high temperature reflow version see part number system

RIPPLE CURRENT FREQUENCY CORRECTION FACTORS

Capacitance (μF)	Frequency			
	100Hz ≤ F < 1KHz	1KHz ≤ F < 10KHz	10KHz ≤ F < 100KHz	100KHz ≤ F
C ≤ 33	0.35	0.70	0.90	1.00
33 < C ≤ 150	0.40	0.85	0.92	1.00
150 < C	0.60	0.85	0.95	1.00

DIMENSIONS (mm)

Case Size	φD±0.5	L max.	A±0.2	B±0.2	I±0.3	W	P±0.3
4x6.3	4.0	6.3	4.3	4.3	1.8	0.5~0.8	1.0
5x6.3	5.0	6.3	5.3	5.3	2.2	0.5~0.8	1.4
6.3x6.3	6.3	6.3	6.6	6.6	2.5	0.5~0.8	2.2
6.3X8	6.3	8.0	6.6	6.6	2.5	0.5~0.8	2.2
8X10.5	8.0	10.5	8.3	8.3	2.9	0.7~1.1	3.2
10X8	10.0	8.0	10.3	10.3	3.2	0.7~1.4	4.6
10X10.5	10.0	10.5	10.3	10.3	3.2	0.7~1.4	4.6
12.5x14	12.5	14.0	12.8	12.8	4.5	1.0~1.4	4.6
16x17	16.0	17.0	16.3	16.3	5.0	1.7~2.1	7.0

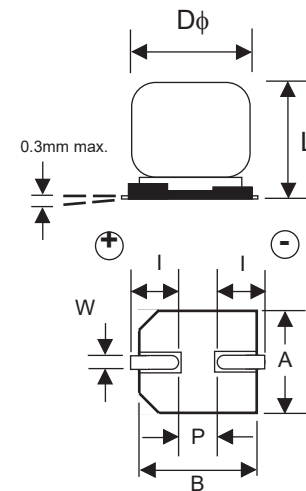

PART NUMBER SYSTEM

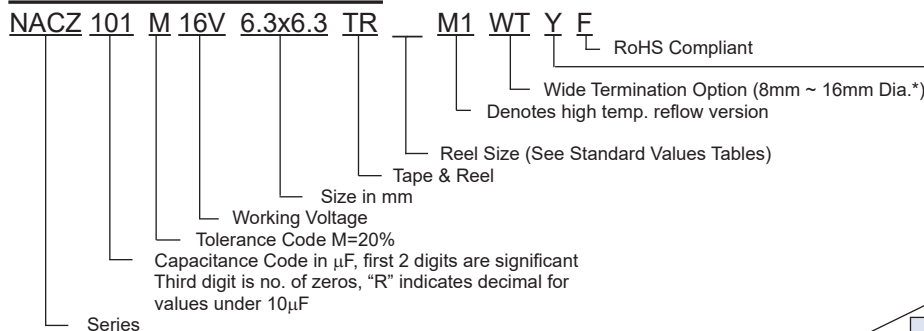

*Wide Terminations not available on 10x8mm case size

Optional: Suitable for automotive equipment, sourced to special production and inspection at IATF-16949 certified production site

Case Diameter	Termination Material
4 ~ 12.5mm φ	97% Sn, 3% Bi
16mm	100% Sn



PEAK REFLOW SOLDERING TEMPERATURES AND DURATIONS (STANDARD VERSION)

Case Size	Preheat: 150°C ~ 180°C	Max. Soldering Temperature	Max. Exposure Time at Max. Soldering Temperature	Max. Exposure Time Above +217°C	Max. Exposure Time Above +200°C	Multiple Reflow Exposure
4x6.3	120 seconds max.	+250°C	5 seconds	60 seconds	70 seconds	2 times max.
5x6.3	120 seconds max.	+250°C	5 seconds	60 seconds	70 seconds	2 times max.
6.3x6.3	120 seconds max.	+250°C	5 seconds	60 seconds	70 seconds	2 times max.
6.3x8	120 seconds max.	+250°C	5 seconds	60 seconds	70 seconds	2 times max.
8x10.5	120 seconds max.	+245°C	5 seconds	50 seconds	60 seconds	2 times max.
10x8	120 seconds max.	+240°C	5 seconds	40 seconds	50 seconds	2 times max.
10x10.5	120 seconds max.	+240°C	5 seconds	40 seconds	50 seconds	2 times max.
12.5x14	120 seconds max.	+240°C	5 seconds	40 seconds	50 seconds	2 times max.
16x17	120 seconds max.	+230°C	5 seconds	30 seconds	50 seconds	2 times max.

PEAK REFLOW SOLDERING TEMPERATURES AND DURATIONS (M1 VERSION)

Case Size	Preheat: 150°C ~ 180°C	Max. Soldering Temperature	Max. Exposure Time at Max. Soldering Temperature	Max. Exposure Time Above +200°C	Max. Exposure Time Above +230°C	Multiple Reflow Exposure
4x6.3	120 seconds max.	+255°C	5 seconds	60 seconds	30 seconds	2 times max.
5x6.3	120 seconds max.	+255°C	5 seconds	60 seconds	30 seconds	2 times max.
6.3x6.3	120 seconds max.	+255°C	5 seconds	60 seconds	30 seconds	2 times max.
6.3x8	120 seconds max.	+255°C	5 seconds	60 seconds	30 seconds	2 times max.
8x10.5	120 seconds max.	+250°C	5 seconds	60 seconds	30 seconds	2 times max.
10x8	120 seconds max.	+250°C	5 seconds	60 seconds	30 seconds	2 times max.
10x10.5	120 seconds max.	+250°C	5 seconds	60 seconds	20 seconds	2 times max.

RECOMMENDED REFLOW SOLDERING PROFILE

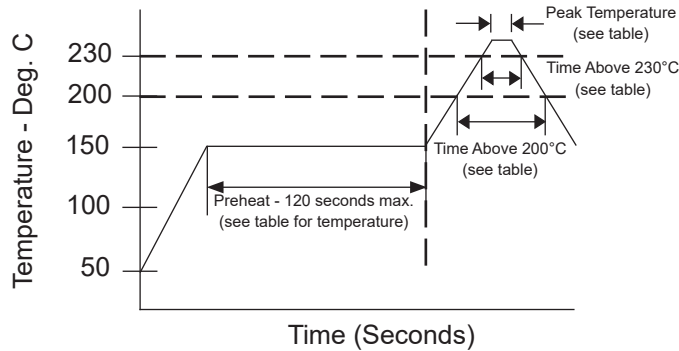

RECOMMENDED LAND PATTERN DIMENSIONS (mm)

Case Size	a	b	c
4 φ	1.0	2.6	1.8
5 φ	1.4	3.0	1.8
6.3 φ	1.8	3.6	1.8
8 φ	2.8	4.1	2.1
10 φ	4.3	4.4	2.5
12.5 φ	4.3	5.8	2.5
16 φ	6.6	6.5	5.0

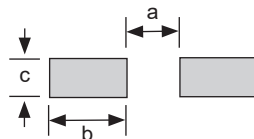

Review & Compare Reflow Soldering Heat Limits
V-chip SMT Aluminum Electrolytic Capacitors
www.niccomp.com/RSL



WT (WIDE TERMINATIONS) COMPONENT DIM. (mm)

Case Size	Dφ ±0.5	L max.	A, B ±0.2	C max.	P	W	R	T
8x10.5	8.0	11.0	8.3	10.0	(3.2)	0.7 ~ 1.1	(0.7)	(1.3)
10x10.5	10.0	11.0	10.3	12.0	(4.6)	0.7 ~ 1.4	(0.7)	(1.3)
12.5x14	12.5	14.5	13.5	15.0	(4.6)	1.0 ~ 1.4	(2.2)	(2.4)
16x17	16.0	17.5	17.0	19.0	(7.0)	1.7 ~ 2.1	(3.0)	(2.0)

(Reference Dimension)

WT (WIDE TERMINATIONS) LAND PATTERN DIM. (mm)

Case Size	a	b	c
8x10.5	2.5	4.5	4.7
10x10.5	3.8	4.8	4.7
12.5x14	3.8	6.1	6.9
16x17	5.0	8.0	9.5

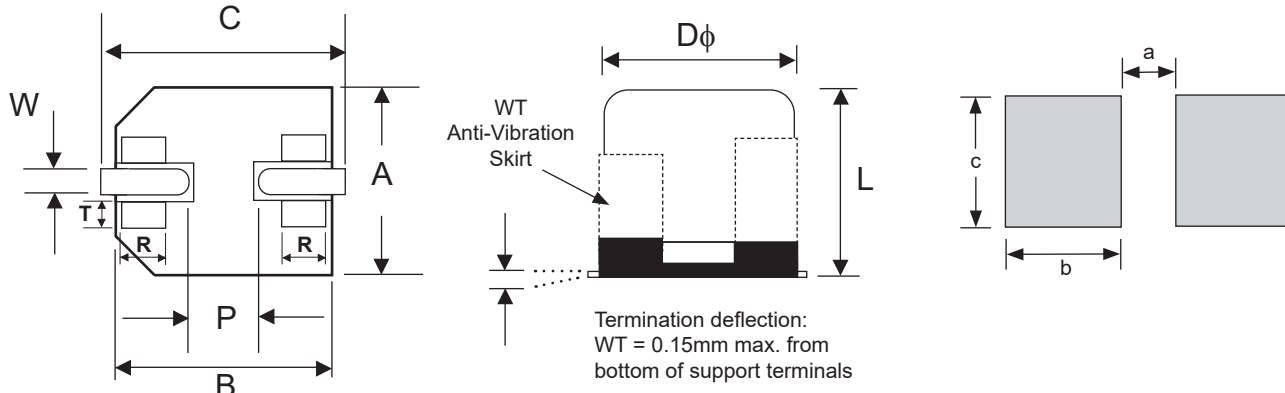

WT (Wide Terminations) Anti-Vibration Test	
Test Method	Direction: X, Y, Z axis Frequency & Duration: 5 to 2000Hz reciprocation for 20 minutes, 2 hours each direction Peak to Peak Amplitude: 5mm Peak Acceleration: 30G Sweep Type: Log
Δ Capacitance	Within ± 10% of initial value
Tangent of Loss	≤ Specified value
Leakage Current	≤ Specified value

PRECAUTIONS

Please review the notes on correct use, safety and precautions found at
<https://www.niccomp.com/resource/files/aluminum/AlumApplInfoCautions.pdf>
 If in doubt or uncertainty, please review your specific application - process details with
 NIC's technical support personnel: tpmg@niccomp.com

CARRIER TAPE

Case Size	A ±0.5	B ±0.2	C ±0.3	D ±0.1	P ±0.1	T ±0.2
4 x 6.3	4.7	4.7	12.0	5.5	8.0	6.4
5 x 6.3	5.7	5.7	12.0	5.5	12.0	6.4
6.3 x 6.3	7.0	7.0	16.0	7.5	12.0	6.5
6.3 x 8	7.0	7.0	16.0	7.5	12.0	8.2
8 X 10.5	8.7	8.7	24.0	11.5	16.0	11.1
10 x 8	10.7	10.7	24.0	11.5	16.0	8.3
10 x 10.5	10.7	10.7	24.0	11.5	16.0	11.2
12.5 x 14	13.2	13.2	32.0	14.2	24.0	14.3
16 x 17	17.5	17.5	44.0	20.2	28.0	17.3

TAPING SPECIFICATIONS (mm)

1. Both Leader and Trailer tape: Minimum 40mm (1.57") empty carrier tape pockets.
2. Leader tape: Approximately 20cm of cover tape at leader.
3. Connection: Maximum 3 connections (slices) per reel.

CARRIER

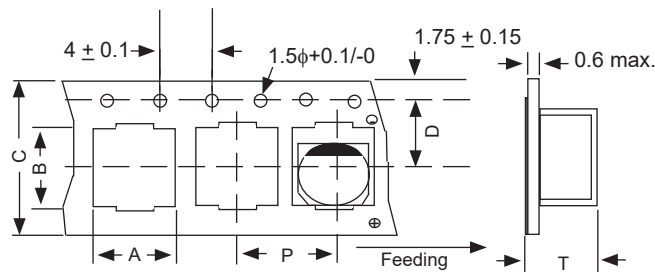

V-Chip 380mm Reels (TR15 suffix)

Dimensions (mm)

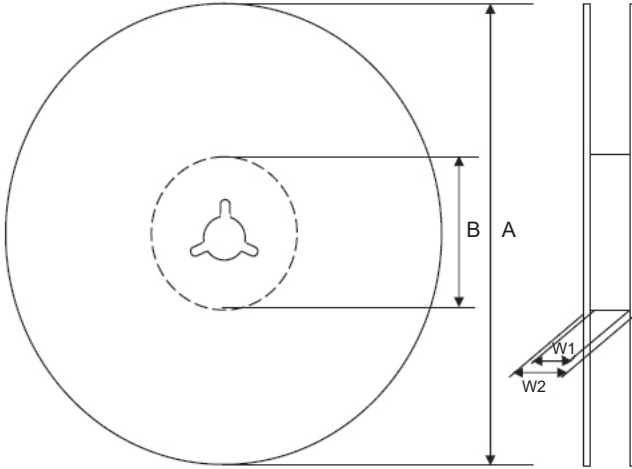

Case Diameter	Tape Width	W1	W2
4x6.3, 5x6.3	12.0	12.4 ~ 14.4	15.5 ~ 20.0
6.3x6.3, 6.3x8	16.0	16.4 ~ 18.4	19.5 ~ 24.0
8x10.5, 10x8, 10x10.5	24.0	24.4 ~ 26.4	27.5 ~ 32.0
12.5x14	32.0	32.4 ~ 35.0	36.2 ~ 38.4
16x17	44.0	44.4 ~ 47.0	48.2 ~ 50.4

Case Size	Tape Width	A	B	C	D	E
4x6.3, 5x6.3	12.0	φ330 ±2.0	φ50~105	φ13 ±0.5	φ21 ±1.0	2.0 ±0.5
6.3x6.3, 6.3x8	16.0					
8x10.5, 10x8, 10x10.5	24.0					
12.5x14	32.0					
16x17	44.0					

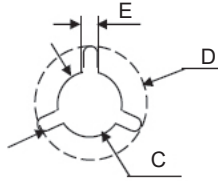

Case Size	15" Reel
4 x 6.3	2,000 pcs
5 x 6.3	1,000 pcs
6.3 x 6.3	1,000 pcs
6.3 x 8	900 pcs
8 X 10.5	500 pcs
10 x 8	500 pcs
10 x 10.5	500 pcs
12.5 x 14	250 pcs
16 x 17	200 pcs