

LOC	DIST	REVISIONS				
P	LTR	DESCRIPTION	DATE	DWN	APVD	
	G	REVISED PER ECR-17-003534	13MAR2017	D.S	S.Y	

- NOTE:
- MATERIAL:
HOUSING: PA9T, UL94 V-0, COLOR: (SEE TABLE).
CONTACTS: BRASS.
 - FINISH:
CONTACTS: 3.05um [120u"] MIN. MATTE-TIN.
1.27um [50u"] MIN. NICKEL UNDERPLATED ALL OVER.
 - WAVE SOLDER CAPABLE TO 265°C PER TEST SPEC.
109-202, CONDITION B.
 - NO TE LOGO AND DATE CODE ON THE PRODUCT WITH 4 POS.
 - THE KEY IDENTIFIED WAS SHOWN ON PAGE 5.

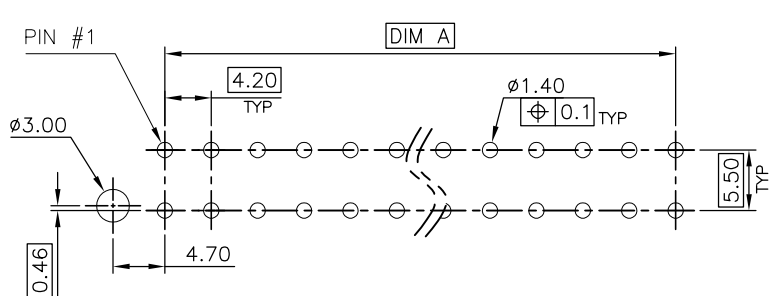

RECOMMENDED PCB LAYOUT
 TOLERANCE: ±0.05 T=1.6mm

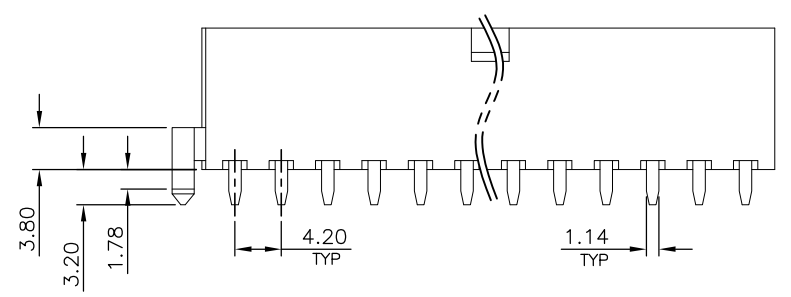
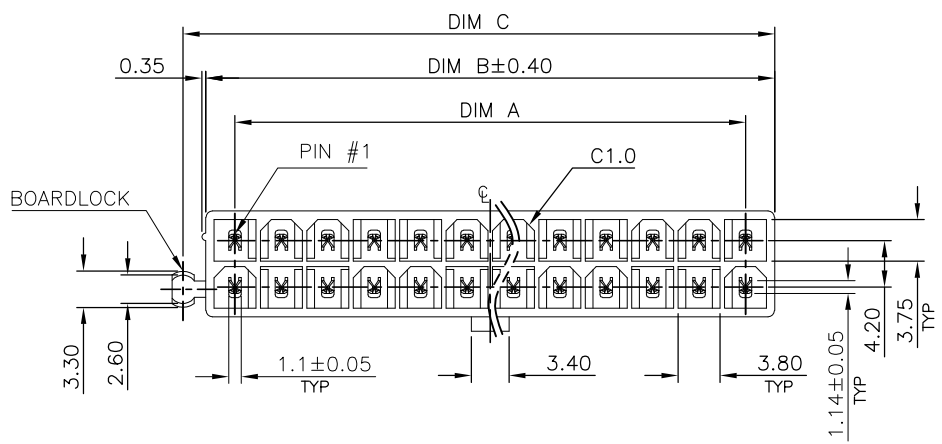
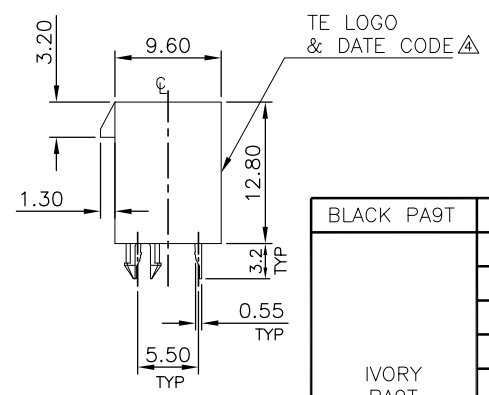

ONE BOARDLOCK
(LEFT)

HSG COLOR & MATERIAL	WEIGHT	DIM A	DIM B	DIM C	POS.	PART NUMBER
BLACK PA9T	1.52	8.4	13.7	15.75	6	6-1775099-6
IVORY PA9T	5.40	46.2	51.5	53.55	24	1-1775099-3
	1.13	4.2	9.5	11.55	4	1-1775099-2
	4.30	37.8	43.1	45.15	20	1-1775099-1
	3.90	33.6	38.9	40.95	18	1-1775099-0
	3.11	25.2	30.5	32.55	14	1775099-9
	2.71	21.0	26.3	28.35	12	1775099-8
	2.31	16.8	22.1	24.15	10	1775099-7
	1.52	8.4	13.7	15.75	6	1775099-6
IVORY PA9T	1.92	12.6	17.9	19.95	8	1775099-5
	5.40	46.2	51.5	53.55	24	1775099-4
TRANSPARENCY PA9T	1.13	4.2	9.5	11.55	4	1775099-3
	5.40	46.2	51.5	53.55	24	1775099-2
1.13	4.2	9.5	11.55	4	1775099-1	

SUPERSEDED TO 1-1775099-3
 SUPERSEDED TO 1-1775099-2

THIS DRAWING IS A CONTROLLED DOCUMENT.

DIMENSIONS: mm	TOLERANCES UNLESS OTHERWISE SPECIFIED: 0 PLC ± - 1 PLC ± 0.3 2 PLC ± 0.2 3 PLC ± 0.15 4 PLC ANGLES ± -	DWN B. HSING 15JUL2009 CHK S. CHIEN 15JUL2009 APVD W. KODAMA 15JUL2009	NAME
MATERIAL SEE NOTE	FINISH SEE NOTE	PRODUCT SPEC 108-57560 APPLICATION SPEC	TE Connectivity
		WEIGHT SEE TABLE	ATX POWER CONNECTOR 4.2mm PITCH, VERTICAL, DIP TYPE
		CUSTOMER DRAWING	SIZE A3 CAGE CODE 00779 DRAWING NO C=1775099 RESTRICTED TO
		SCALE -	SHEET 1 OF 6 REV G

THIS DRAWING IS UNPUBLISHED. RELEASED FOR PUBLICATION
 © COPYRIGHT 2010 BY TYCO ELECTRONICS CORPORATION. ALL RIGHTS RESERVED.

LOC	DIST	REVISIONS			
P	LTR	DESCRIPTION	DATE	DWN	APVD
		SEE SHEET 1.			

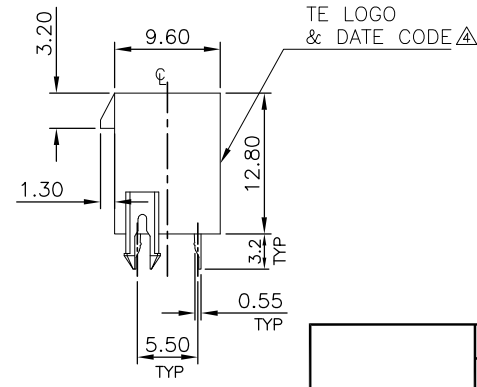
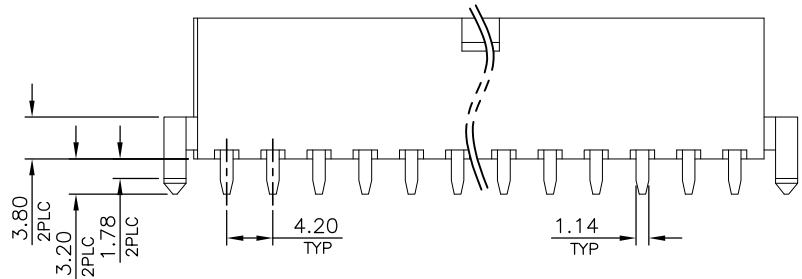
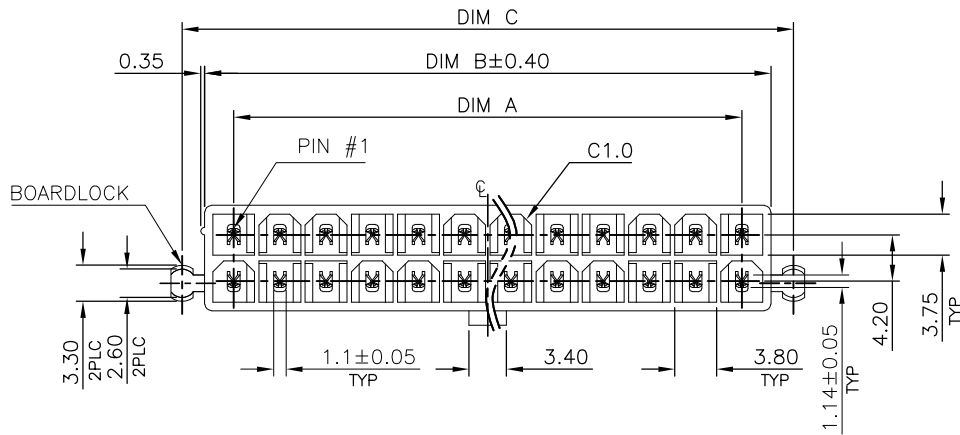

TWO BOARDLOCK

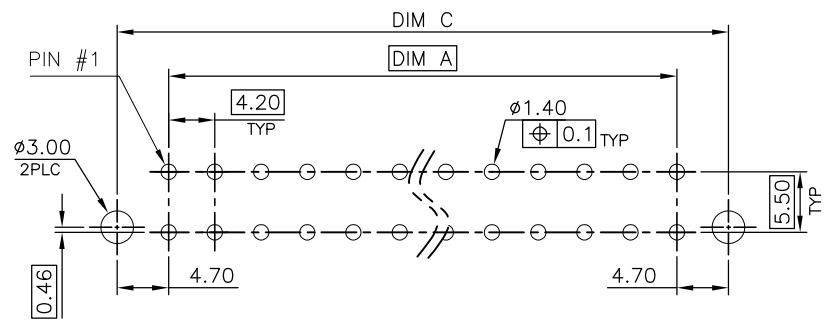

RECOMMENDED PCB LAYOUT
 TOLERANCE: ±0.05 T=1.6mm

- NOTE:
- MATERIAL:
HOUSING: PA9T, UL94 V-0, COLOR: (SEE TABLE).
CONTACTS: BRASS.
 - FINISH:
CONTACTS: 3.05um [120u"] MIN. MATTE-TIN.
1.27um [50u"] MIN. NICKEL UNDERPLATED ALL OVER.
 - WAVE SOLDER CAPABLE TO 265°C PER TEST SPEC.
109-202, CONDITION B.
 - NO TE LOGO AND DATE CODE ON THE PRODUCT WITH 4 POS.
 - THE KEY IDENTIFIED WAS SHOWN ON PAGE 5.

IVORY PA9T	3.54	29.4	34.7	38.8	16	2-1775099-9
	5.43	46.2	51.5	55.6	24	2-1775099-8
	4.33	37.8	43.1	47.2	20	2-1775099-7
	3.93	33.6	38.9	43.0	18	2-1775099-6
	3.14	25.2	30.5	34.6	14	2-1775099-5
	2.74	21.0	26.3	30.4	12	2-1775099-4
	2.34	16.8	22.1	26.2	10	2-1775099-3
	1.95	12.6	17.9	22.0	8	2-1775099-2
	1.55	8.4	13.7	17.8	6	2-1775099-1
	1.16	4.2	9.5	13.6	4	2-1775099-0
HSG COLOR & MATERIAL	WEIGHT	DIM A	DIM B	DIM C	POS.	PART NUMBER

THIS DRAWING IS A CONTROLLED DOCUMENT.

DIMENSIONS: mm	TOLERANCES UNLESS OTHERWISE SPECIFIED:	DWN		TE Connectivity	
	0 PLC ±	CHK	NAME		
	1 PLC ±0.3	APVD	ATX POWER CONNECTOR		
	2 PLC ±0.2	PRODUCT SPEC	4.2mm PITCH, VERTICAL, DIP TYPE		
	3 PLC ±0.15	APPLICATION SPEC	SIZE	CAGE CODE	DRAWING NO
	4 PLC ±	WEIGHT	A3	00779	C=1775099
	ANGLES ± 3°	CUSTOMER DRAWING	SCALE	SHEET	REV
MATERIAL	FINISH	RESTRICTED TO		2 OF 6	G

THIS DRAWING IS UNPUBLISHED. RELEASED FOR PUBLICATION
 © COPYRIGHT 2010 BY TYCO ELECTRONICS CORPORATION. ALL RIGHTS RESERVED.

LOC		DIST		REVISIONS				
P	LTR	DESCRIPTION			DATE	DWN	APVD	
		SEE SHEET 1.						

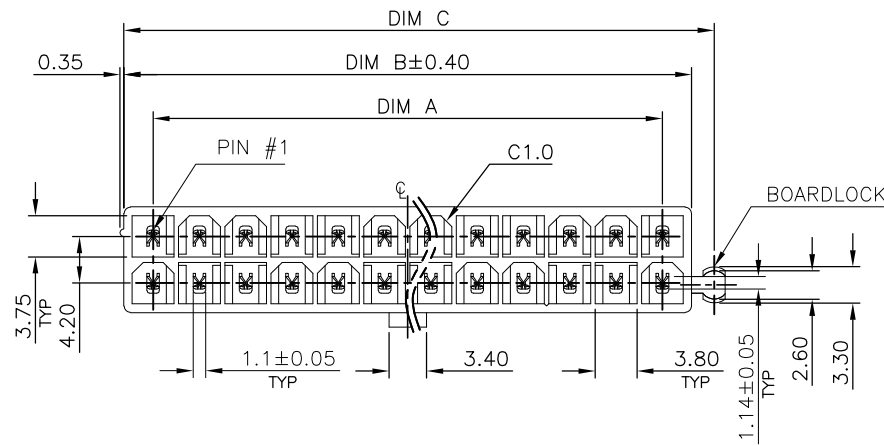

- NOTE:
- MATERIAL:
HOUSING: PA9T, UL94 V-0, COLOR: (SEE TABLE).
CONTACTS: BRASS.
 - FINISH:
CONTACTS: 3.05um [120u"] MIN. MATTE-TIN.
1.27um [50u"] MIN. NICKEL UNDERPLATED ALL OVER.
 - WAVE SOLDER CAPABLE TO 265°C PER TEST SPEC.
109-202, CONDITION B.
 - NO TE LOGO AND DATE CODE ON THE PRODUCT WITH 4 POS.
 - THE KEY IDENTIFIED WAS SHOWN ON PAGE 5.

ONE BOARDLOCK
(RIGHT)

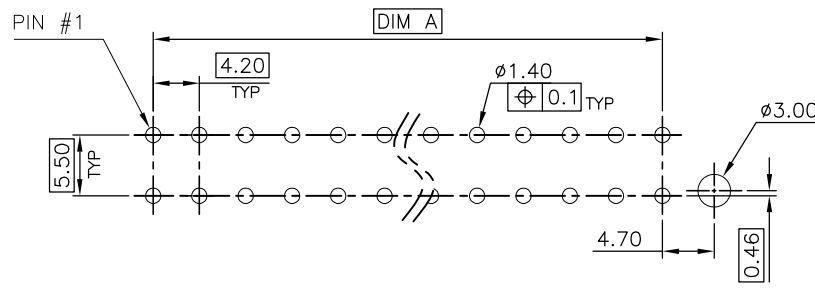
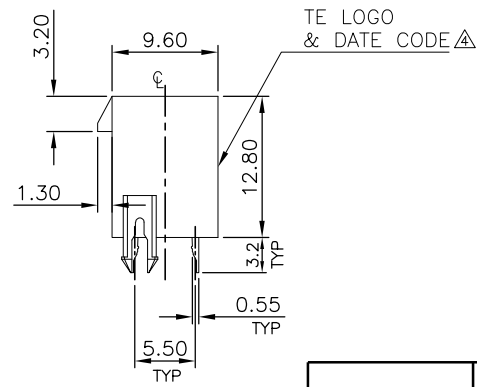
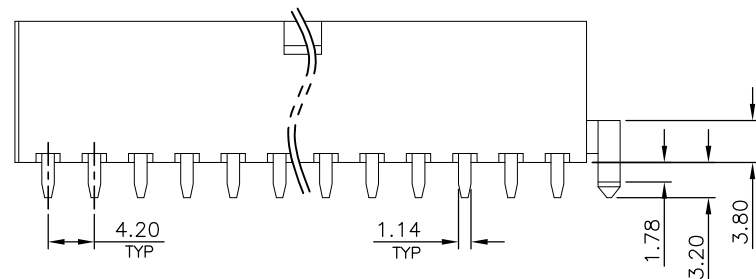

RECOMMENDED PCB LAYOUT
TOLERANCE: ±0.05 T=1.6mm

IVORY PA9T	5.40	46.2	51.5	53.55	24	3-1775099-8
	4.30	37.8	43.1	45.15	20	3-1775099-7
	3.90	33.6	38.9	40.95	18	3-1775099-6
	3.11	25.2	30.5	32.55	14	3-1775099-5
	2.71	21.0	26.3	28.35	12	3-1775099-4
	2.31	16.8	22.1	24.15	10	3-1775099-3
	1.92	12.6	17.9	19.95	8	3-1775099-2
	1.52	8.4	13.7	15.75	6	3-1775099-1
1.13	4.2	9.5	11.55	4	3-1775099-0	
HSG COLOR & MATERIAL	WEIGHT	DIM A	DIM B	DIM C	POS.	PART NUMBER

THIS DRAWING IS A CONTROLLED DOCUMENT.

DIMENSIONS:	TOLERANCES UNLESS OTHERWISE SPECIFIED:	DWN	TE Connectivity	
mm	0 PLC ± -	CHK	NAME	
	1 PLC ± 0.3	APVD	ATX POWER CONNECTOR	
	2 PLC ± 0.2	PRODUCT SPEC	4.2mm PITCH, VERTICAL, DIP TYPE	
	3 PLC ± 0.15	APPLICATION SPEC	SIZE	RESTRICTED TO
	4 PLC ANGLES ± 3'	WEIGHT	CAGE CODE	DRAWING NO
MATERIAL	FINISH	SEE TABLE	A300779	C-1775099
		CUSTOMER DRAWING	SCALE	SHEET 3 OF 6

THIS DRAWING IS UNPUBLISHED. RELEASED FOR PUBLICATION
 © COPYRIGHT 2010 BY TYCO ELECTRONICS CORPORATION. ALL RIGHTS RESERVED.

LOC		DIST		REVISIONS				
P	LTR	DESCRIPTION			DATE	DWN	APVD	
		SEE SHEET 1.						

- NOTE:
- MATERIAL:
HOUSING: PA9T, UL94 V-0, COLOR: (SEE TABLE).
CONTACTS: BRASS.
 - FINISH:
CONTACTS: 3.05um [120u"] MIN. MATTE-TIN.
1.27um [50u"] MIN. NICKEL UNDERPLATED ALL OVER.
 - WAVE SOLDER CAPABLE TO 265°C PER TEST SPEC.
109-202, CONDITION B.
 - NO TE LOGO AND DATE CODE ON THE PRODUCT WITH 4 POS.
 - THE KEY IDENTIFIED WAS SHOWN ON PAGE 5.

NO BOARDLOCK

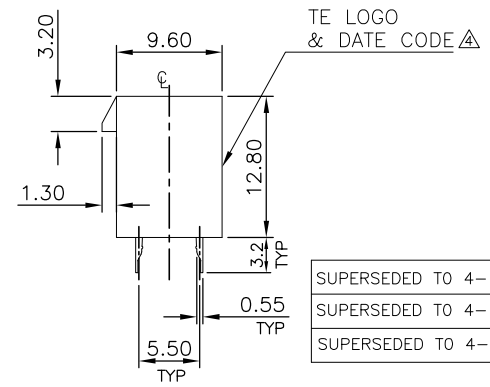
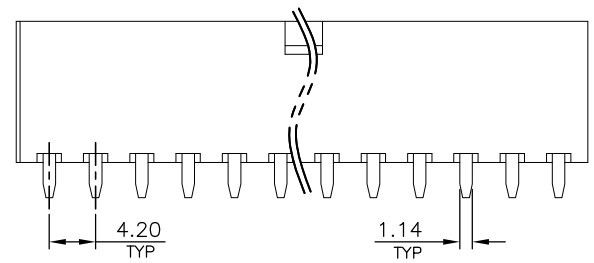
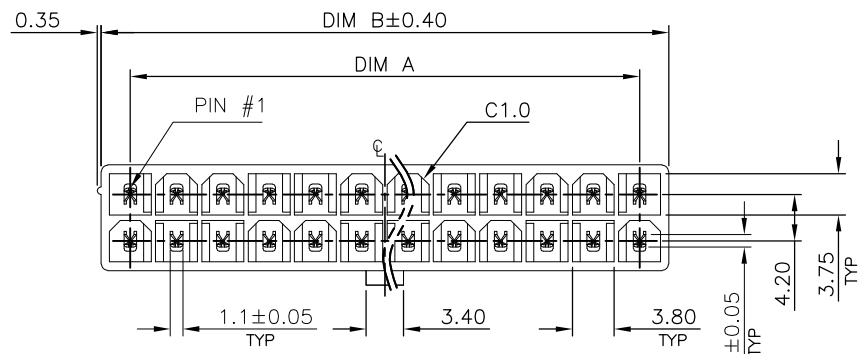

SUPERSEDED TO	IVORY PA9T	2.28	16.8	22.1	10	5-1775099-3
4-1775099-3		1.89	12.6	17.9	8	5-1775099-2
4-1775099-2		1.49	8.4	13.7	6	5-1775099-1
4-1775099-1		5.37	46.2	51.5	24	4-1775099-8
		4.27	37.8	43.1	20	4-1775099-7
		3.87	33.6	38.9	18	4-1775099-6
		3.08	25.2	30.5	14	4-1775099-5
		2.68	21.0	26.3	12	4-1775099-4
		2.28	16.8	22.1	10	4-1775099-3
		1.89	12.6	17.9	8	4-1775099-2
		1.49	8.4	13.7	6	4-1775099-1
		1.10	4.2	9.5	4	4-1775099-0
	HSG COLOR & MATERIAL	WEIGHT	DIM A	DIM B	POS.	PART NUMBER

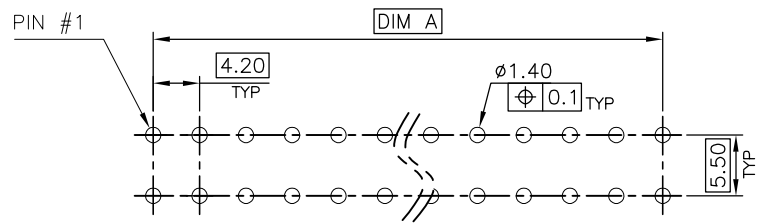

RECOMMENDED PCB LAYOUT
 TOLERANCE: ±0.05 T=1.6mm

THIS DRAWING IS A CONTROLLED DOCUMENT.

DIMENSIONS:	TOLERANCES UNLESS OTHERWISE SPECIFIED:	DWN	TE Connectivity		
mm		CHK	NAME		
0 PLC ±	±	APVD	ATX POWER CONNECTOR		
1 PLC ±0.3	±0.3	PRODUCT SPEC	4.2mm PITCH, VERTICAL, DIP TYPE		
2 PLC ±0.2	±0.2	APPLICATION SPEC	SIZE	CAGE CODE	DRAWING NO
3 PLC ±0.15	±0.15	WEIGHT	A3	00779	C-1775099
4 PLC ANGLES ±3'	±3'	CUSTOMER DRAWING	RESTRICTED TO		
MATERIAL	FINISH	SCALE	SHEET 4 of 6		REV G

LOC	DIST	REVISIONS					
DW		P	LTR	DESCRIPTION	DATE	DWN	APVD
				SEE SHEET 1.			

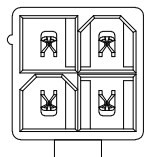

4 POS

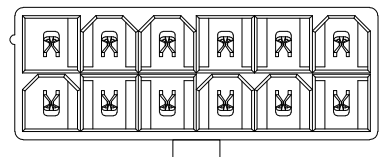

12 POS

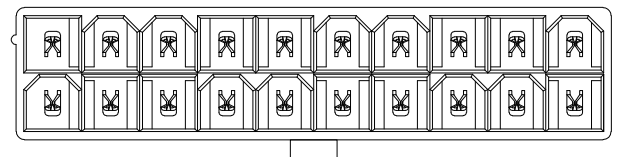

20 POS

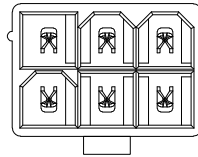

6 POS

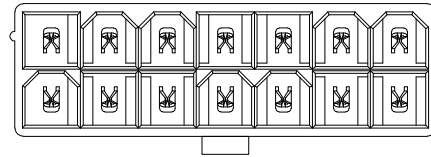

14 POS

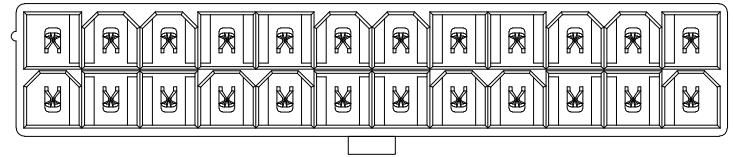

24 POS

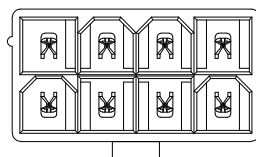

8 POS

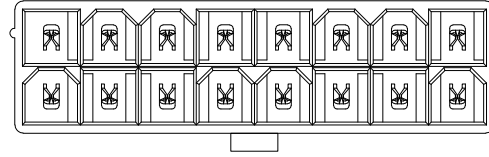

16 POS

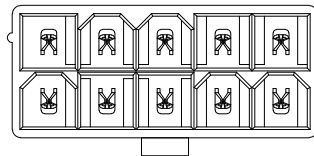

10 POS

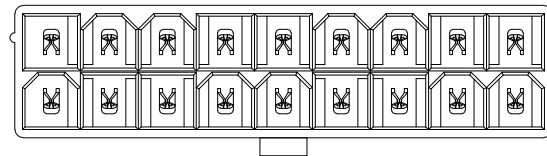

18 POS

KEY POSITION IDENTIFIED
(TOP VIEW)

THIS DRAWING IS A CONTROLLED DOCUMENT.		DWN	TE Connectivity	
DIMENSIONS: mm		CHK	NAME	
TOLERANCES UNLESS OTHERWISE SPECIFIED:		APVD	ATX POWER CONNECTOR 4.2mm PITCH, VERTICAL, DIP TYPE	
0 PLC ± -		PRODUCT SPEC	SIZE	CAGE CODE
1 PLC ± 0.3		APPLICATION SPEC	A3	00779
2 PLC ± 0.2		WEIGHT	DRAWING NO	
3 PLC ± 0.15		CUSTOMER DRAWING	C=1775099	
4 PLC ± -		SCALE	RESTRICTED TO	
ANGLES ± 3'		SHEET	5 of 6	
MATERIAL	FINISH	REV	G	

4

3

2

1

THIS DRAWING IS UNPUBLISHED. RELEASED FOR PUBLICATION
 © COPYRIGHT 2010 BY TYCO ELECTRONICS CORPORATION. ALL RIGHTS RESERVED.

LOC		DIST		REVISIONS					
P	LTR	DESCRIPTION			DATE	DWN	APVD		
		SEE SHEET 1.							

D
C
B
A

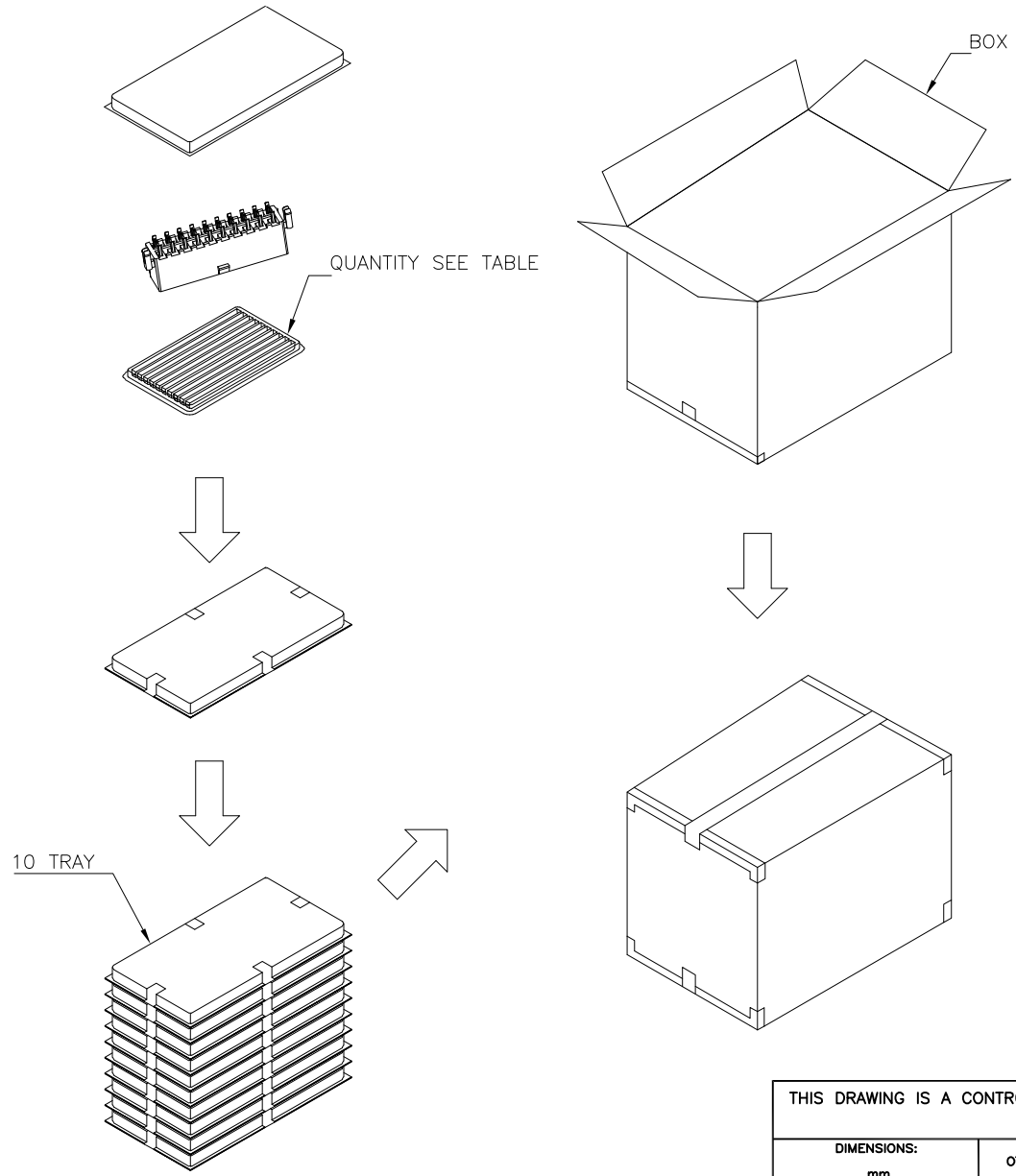

- NOTES:
 1. TRAY : PVC, SIZE: 330mm(L)X 265mm(W)X 22mm(H).
 2. BOX : CORRUGATED, SIZE: 350mm(L)X 279mm(W)X 195mm(H).
 3. QUANTITY: SEE TABLE.

GROSS WEIGHT	NET WEIGHT	PCS /TRAY	TRAYS /BOX	PCS /BOX	POS.	NO. OF BOARDLOCK
5.94	4.34	80	10	800	24	2
5.93	4.33	100	10	1000	20	
5.53	3.93	100	10	1000	18	
5.85	4.25	120	10	1200	16	
6.00	4.40	140	10	1400	14	
5.98	4.38	160	10	1600	12	
5.81	4.21	180	10	1800	10	
5.89	4.29	220	10	2200	8	
5.94	4.34	280	10	2800	6	
5.78	4.18	360	10	3600	4	
5.92	4.32	80	10	800	24	1
5.90	4.30	100	10	1000	20	
6.28	4.68	120	10	1200	18	
5.95	4.35	140	10	1400	14	
5.94	4.34	160	10	1600	12	
6.22	4.62	200	10	2000	10	
6.21	4.61	240	10	2400	8	
6.16	4.56	300	10	3000	6	
6.35	4.75	420	10	4200	4	
5.90	4.30	80	10	800	24	
5.87	4.27	100	10	1000	20	
6.24	4.64	120	10	1200	18	
5.91	4.31	140	10	1400	14	
6.42	4.82	180	10	1800	12	
6.16	4.56	200	10	2000	10	
6.51	4.91	260	10	2600	8	
6.67	5.07	340	10	3400	6	
6.88	5.28	480	10	4800	4	

THIS DRAWING IS A CONTROLLED DOCUMENT.

DIMENSIONS: mm	TOLERANCES UNLESS OTHERWISE SPECIFIED:	DWN	TE Connectivity			
	0 PLC ± -	CHK	NAME			
	1 PLC ± 0.3	APVD	ATX POWER CONNECTOR			
	2 PLC ± 0.2	PRODUCT SPEC	4.2mm PITCH, VERTICAL, DIP TYPE			
	3 PLC ± 0.15	APPLICATION SPEC	SIZE	CAGE CODE	DRAWING NO	RESTRICTED TO
4 PLC ± -	ANGLES ± 3'	WEIGHT	A3	00779	C=1775099	
MATERIAL	FINISH	CUSTOMER DRAWING	SCALE	SHEET	6 OF 6	REV G

Mouser Electronics

Authorized Distributor

Click to View Pricing, Inventory, Delivery & Lifecycle Information:

[TE Connectivity:](#)

[1-1775099-3](#)