

THIS DRAWING IS UNPUBLISHED. RELEASED FOR PUBLICATION
 © COPYRIGHT - By - ALL RIGHTS RESERVED.

LOC		DIST		REVISIONS			
P	LTR	DESCRIPTION		DATE	DWN	APVD	
GP	00	D1	REVISED PER ECO-11-004835		11MAR11	RK	HMR

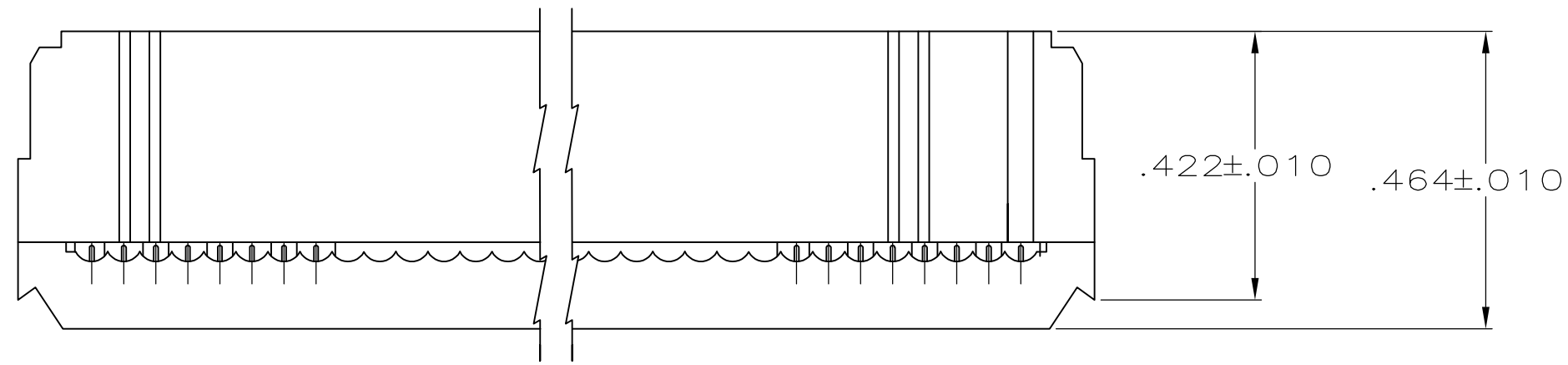

- 1 UL RATED 94V-0 THERMOPLASTIC, COLOR: BLACK.
- 2 PHOSPHOR BRONZE PER QQ-B-750.
- 3 PLATED WITH .000015 MIN GOLD IN LOCALIZED GOLD PLATE AREA, .000050 MIN TIN ON TERMINATION END, ALL OVER .000050 MIN NICKEL ON ENTIRE CONTACT.
OR
GOLD FLASH OVER PALLADIUM-NICKEL PLATE .000015 MIN TOTAL IN LOCALIZED GOLD PLATE AREA, .000050 MIN TIN ON TERMINATION END, ALL OVER .000050 MIN NICKEL ON ENTIRE CONTACT.
- 4 POLARIZING FEATURE DOES NOT EXIST ON SAME END AS THE POSN #1 INDICATOR ON 10 AND 14 POSN PRODUCT.

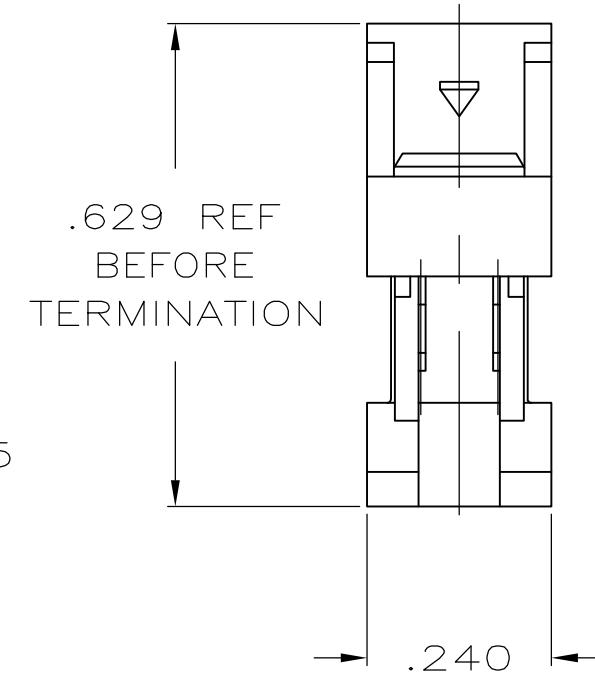
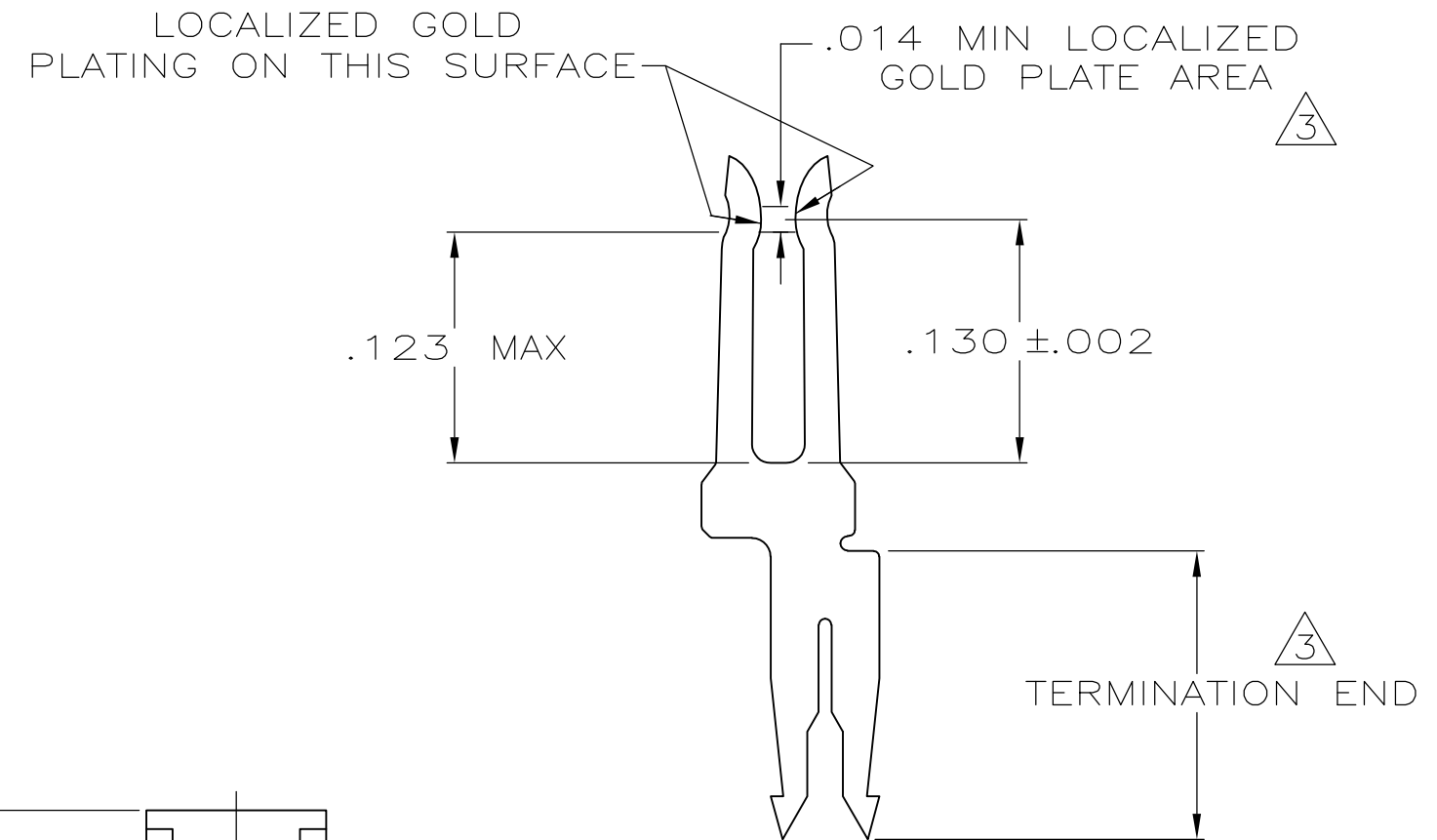
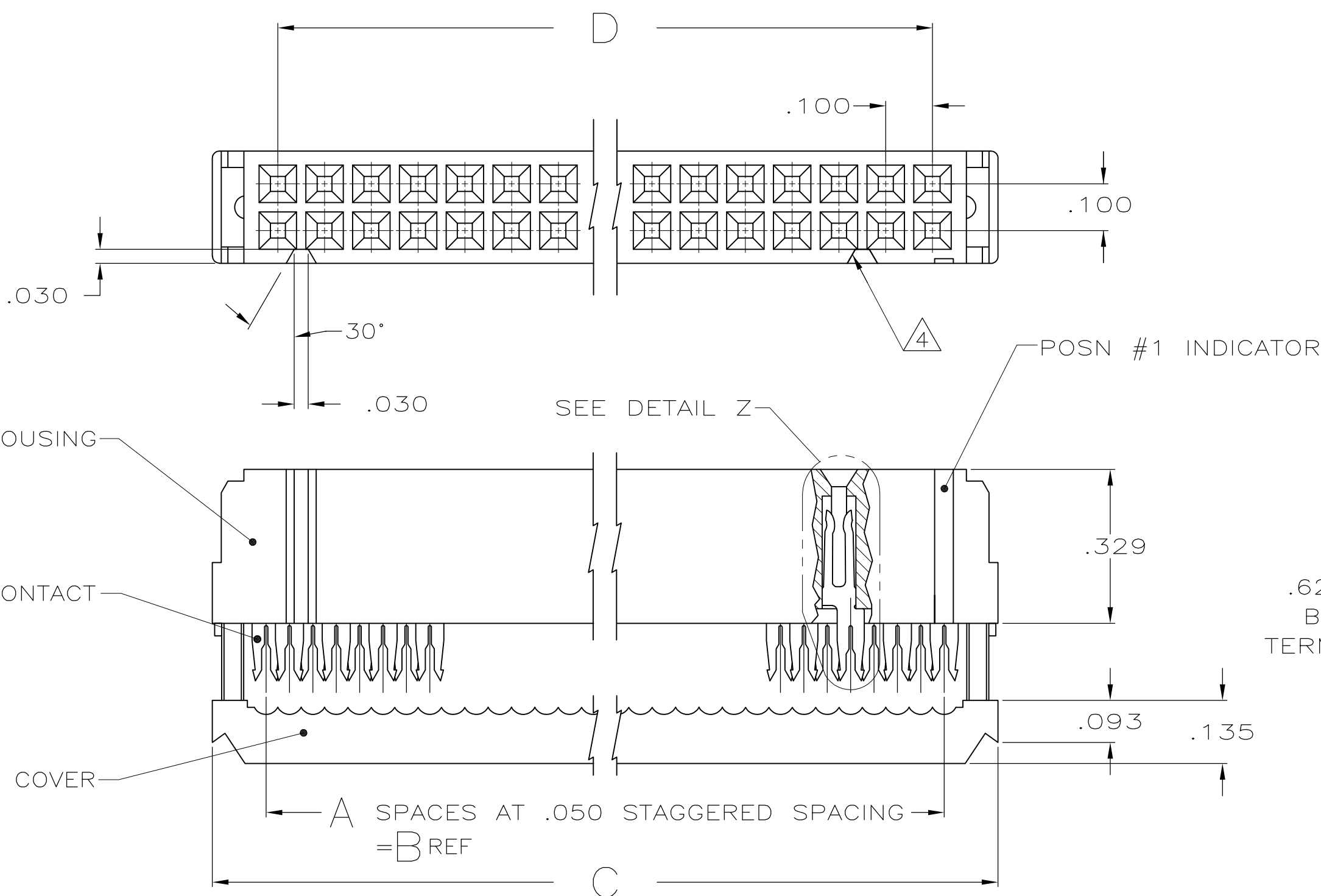

DETAIL Z
SCALE 10:1
TYPICAL

	D	C	B	A	NO OF POSN	PART NUMBER
OBSOLETE	3.100	3.380	3.150	63	64	1-1658620-2
	2.900	3.180	2.950	59	60	1-1658620-1
	2.400	2.680	2.450	49	50	1-1658620-0
	1.900	2.180	1.950	39	40	1658620-9
	1.600	1.880	1.650	33	34	1658620-8
	1.400	1.680	1.450	29	30	1658620-7
	1.200	1.480	1.250	25	26	1658620-6
	.900	1.180	.950	19	20	1658620-4
	.700	.980	.750	15	16	1658620-3
	.600	.880	.650	13	14	1658620-2
	.400	.680	.450	9	10	1658620-1

THIS DRAWING IS A CONTROLLED DOCUMENT.

DIMENSIONS: INCHES	TOLERANCES UNLESS OTHERWISE SPECIFIED:	DWN R. SAMICK 22AUG03	TE Connectivity	
	0 PLC ± -	CHK C. ROHDE 22AUG03	RECEPTACLE ASSY, MILITARY POLARIZATION, LEAD FREE, AMP-LATCH™ NOVO	
	1 PLC ± -	APVD M. WALMSLEY 22AUG03	SIZE A2	CAGE CODE 00779
	2 PLC ± -	PRODUCT SPEC 108-40000	DRAWING NO C=1658620	RESTRICTED TO -
	3 PLC ± .005	APPLICATION SPEC 114-40005	SCALE 4:1	SHEET 1 of 1
MATERIAL	FINISH	WEIGHT -	CUSTOMER DRAWING	REV D1

Mouser Electronics

Authorized Distributor

Click to View Pricing, Inventory, Delivery & Lifecycle Information:

[TE Connectivity:](#)

[1658620-1](#)