

THIS DRAWING IS UNPUBLISHED. RELEASED FOR PUBLICATION 2011  
 © COPYRIGHT 2011 ALL RIGHTS RESERVED.

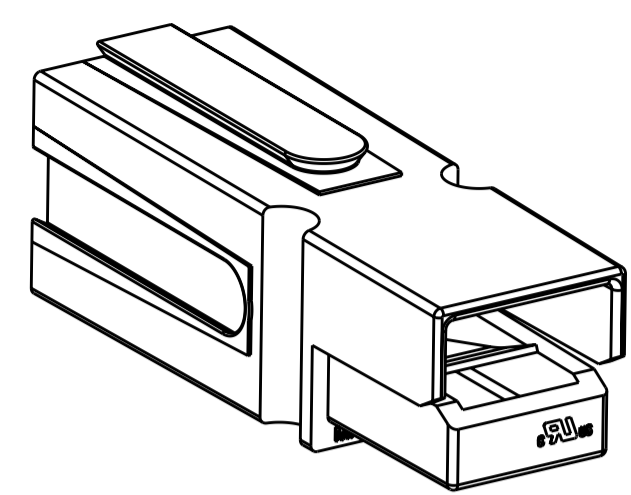

PART NUMBERS  
 1445715-1 THRU 1445715-5  
 WITHOUT LOCKING FEATURE

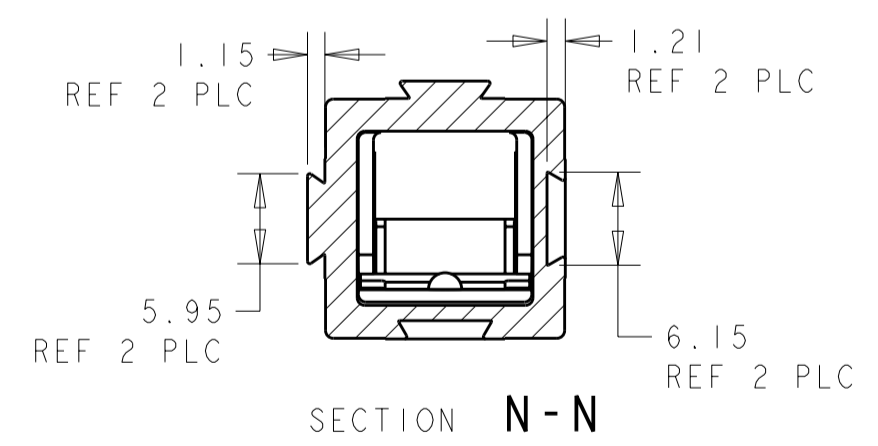
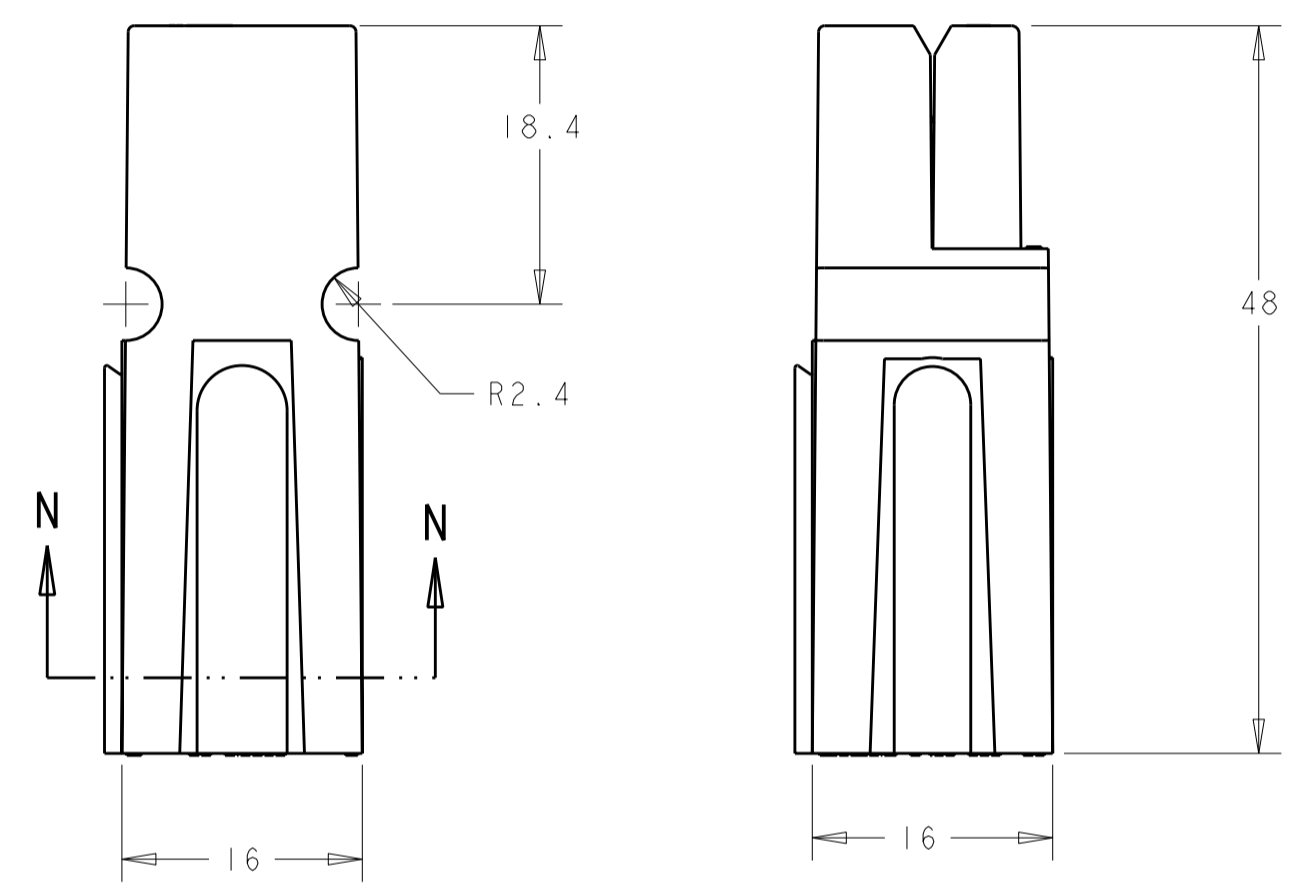

1445715-1 TO 1445715-5  
 WITHOUT LOCKING FEATURE

LOC	DIST	REVISIONS					
CM	00	P	LTR	DESCRIPTION	DATE	DWN	APVD
		B		REVISED PER ECO-11-008363	18MAY2011	HMR	DY

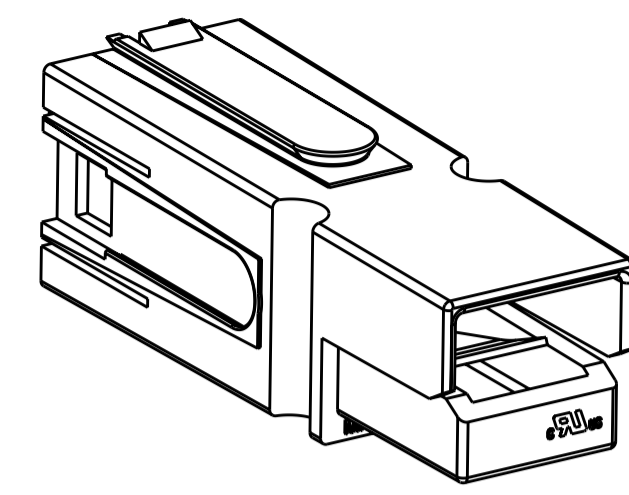

PART NUMBERS  
 1445715-6 THRU 1-1445715-0  
 WITH LOCKING FEATURE

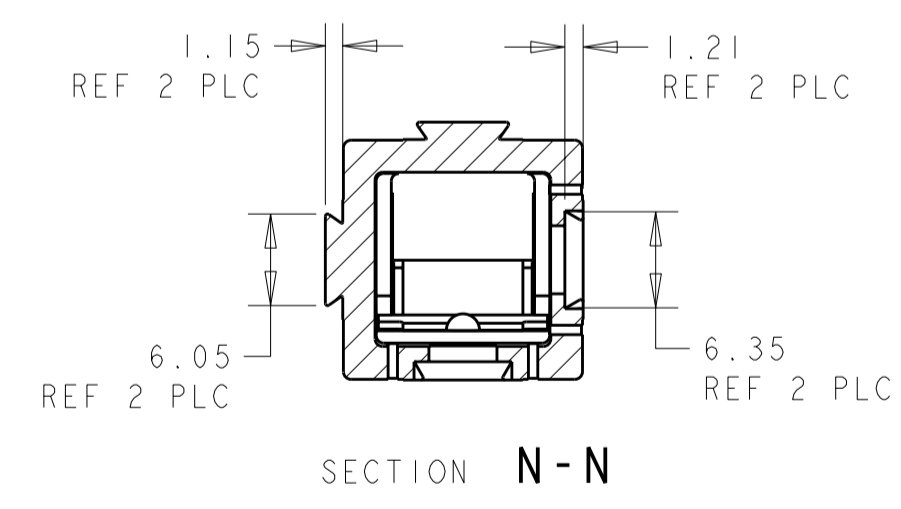
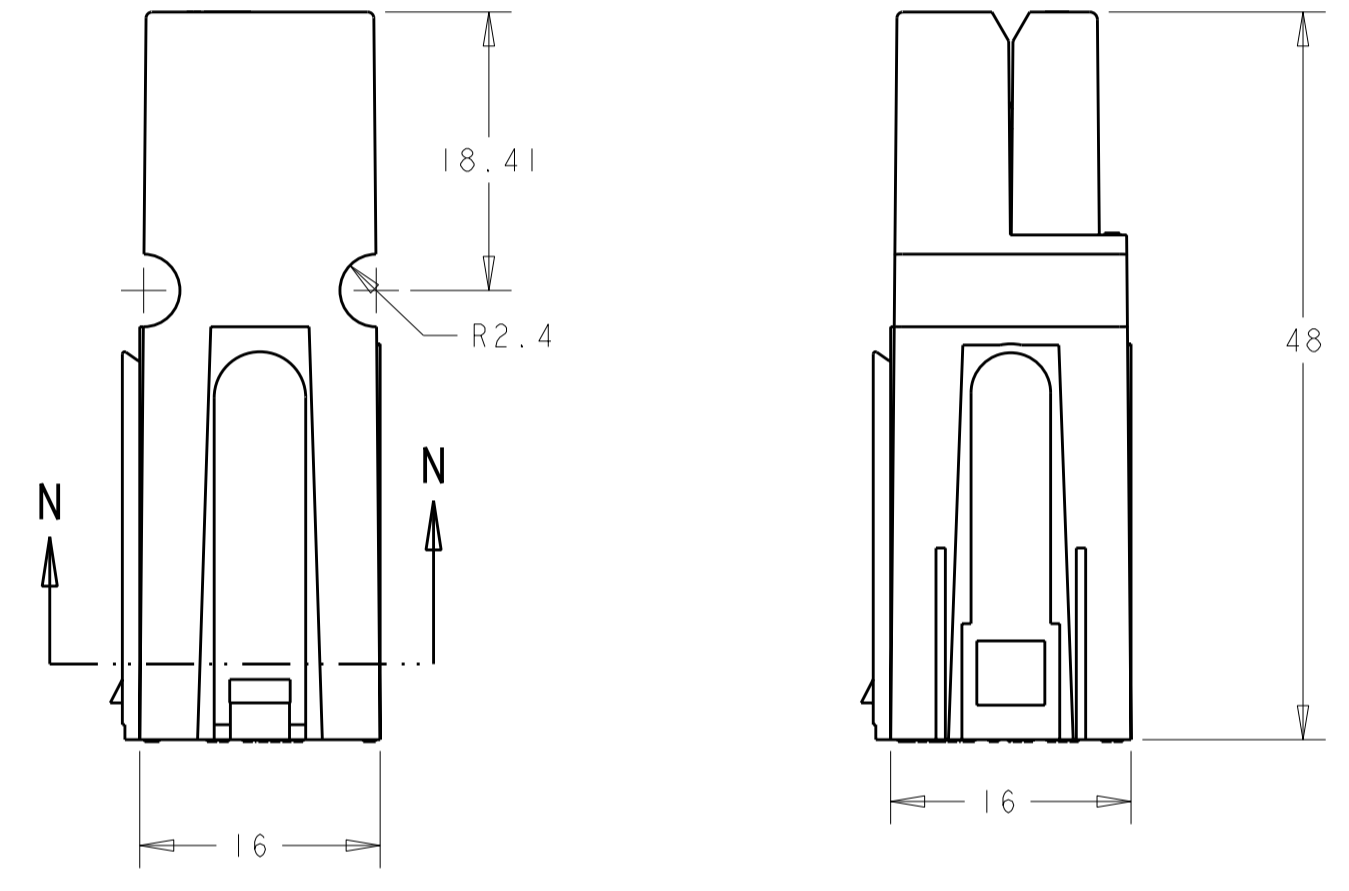

1445715-6 TO 1-1445715-0  
 WITH LOCKING FEATURE

1. THIS PRODUCT HAS PASSED VERIFICATION AND AGENCY APPROVALS TESTING AND IS COMPONENT RECOGNIZED PER UL 1977 AND CSA 22.2. TYCO ELECTRONICS PRODUCT QUALIFICATION TESTING IS NOT YET COMPLETED.

DESCRIPTION	COLOR	PART NUMBER
WITH LOCKING FEATURE	RED	1-1445715-0
WITH LOCKING FEATURE	GREEN	1445715-9
WITH LOCKING FEATURE	WHITE	1445715-8
WITH LOCKING FEATURE	BLACK	1445715-7
WITH LOCKING FEATURE	BLUE	1445715-6
WITHOUT LOCKING FEATURE	RED	1445715-5
WITHOUT LOCKING FEATURE	GREEN	1445715-4
WITHOUT LOCKING FEATURE	WHITE	1445715-3
WITHOUT LOCKING FEATURE	BLACK	1445715-2
WITHOUT LOCKING FEATURE	BLUE	1445715-1



THIS DRAWING IS A CONTROLLED DOCUMENT.

DWN	BH	04OCT01
CHK	KAK	04OCT01
APVD	KAK	04OCT01

TE Connectivity

CONNECTOR ASSEMBLY, AMP POWER SERIES 75

SIZE: A2 CAGE CODE: 200779 DRAWING NO: 1445715

SCALE: 2:1 SHEET 1 OF 1 REV B

CUSTOMER DRAWING

# Mouser Electronics

Authorized Distributor

Click to View Pricing, Inventory, Delivery & Lifecycle Information:

[TE Connectivity:](#)

[1445715-7](#)