

**PLEASE CHECK WWW.MOLEX.COM FOR LATEST PART INFORMATION**

**Part Number:** [42819-3223](#)  
**Status:** **Active**  
**Overview:** Mini-Fit Sr.™ Power Connectors  
**Description:** 10.00mm Pitch Mini-Fit Sr.™ Header, Single Row, Vertical, 2.36mm PCB Thickness, 0.76µm Gold (Au) Selective Plating, 3 Circuits

**Documents:**

[3D Model](#) [Product Specification PS-42815-001 \(PDF\)](#)  
[Drawing \(PDF\)](#) [RoHS Certificate of Compliance \(PDF\)](#)

**Agency Certification**

CSA	LR19980
TUV	R72131193
UL	E29179

**General**

Product Family	PCB Headers
Series	<a href="#">42819</a>
Application	Power, Wire-to-Board
Overview	<a href="#">Mini-Fit Sr.™ Power Connectors</a>
Product Name	Mini-Fit Sr.™
UPC	800756513461

**Physical**

Breakaway	No
Circuits (Loaded)	3
Circuits (maximum)	3
Color - Resin	Black
Durability (mating cycles max)	100
First Mate / Last Break	No
Flammability	94V-0
Glow-Wire Compliant	No
Guide to Mating Part	No
Keying to Mating Part	None
Lock to Mating Part	Yes
Material - Metal	Brass
Material - Plating Mating	Gold
Material - Plating Termination	Tin
Material - Resin	High Temperature Thermoplastic
Net Weight	7.523/g
Number of Rows	1
Orientation	Vertical
PC Tail Length	5.10mm
PCB Locator	Yes
PCB Retention	Yes
PCB Thickness - Recommended	2.40mm
Packaging Type	Tray
Pitch - Mating Interface	10.00mm
Pitch - Termination Interface	10.00mm
Plating min - Mating	0.762µm
Plating min - Termination	2.540µm
Polarized to Mating Part	Yes
Polarized to PCB	Yes
Shrouded	Fully
Stackable	No
Surface Mount Compatible (SMC)	No

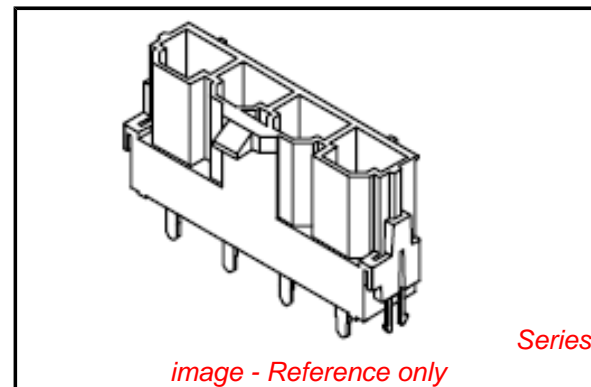

**EU RoHS**

**ELV and RoHS Compliant**

**REACH SVHC**

Not Reviewed

**Low-Halogen Status**

**Not Low-Halogen**

**China RoHS**



**Need more information on product environmental compliance?**

Email [productcompliance@molex.com](mailto:productcompliance@molex.com)  
 For a multiple part number RoHS Certificate of Compliance, [click here](#)

Please visit the [Contact Us](#) section for any non-product compliance questions.

**Search Parts in this Series**

[42819Series](#)

**Mates With**

[42816 Mini-Fit Sr.™ Receptacle Housing with TPA](#)

Temperature Range - Operating -40°C to +105°C  
Termination Interface: Style Through Hole

### **Electrical**

Current - Maximum per Contact 50A  
Voltage - Maximum 600V

### **Solder Process Data**

Duration at Max. Process Temperature (seconds) 30  
Lead-free Process Capability SMC & Wave Capable (TH only)  
Max. Cycles at Max. Process Temperature 3  
Process Temperature max. C 235

### **Material Info**

#### **Reference - Drawing Numbers**

Product Specification PS-42815-001, RPS-42815-011, RPS-42815-012,  
RPS-42815-013, RPS-42815-014  
Sales Drawing SDA-42819-0002

This document was generated on 01/20/2015

**PLEASE CHECK [WWW.MOLEX.COM](http://WWW.MOLEX.COM) FOR LATEST PART INFORMATION**