

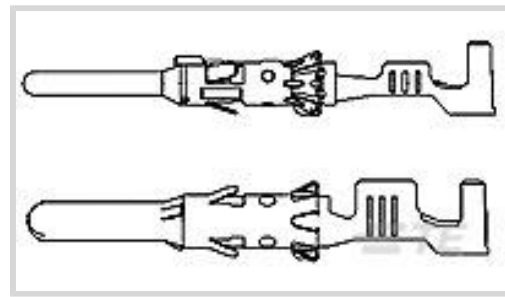

Terminals & Splices > Automotive Terminals > ROUND CONNECTOR SYSTEM, PIN AND SOCKET



Terminal Type: Pin

Mating Pin Diameter: 2.5 mm [.098 in]

Terminal Transmits: 25 – 40 A (Power)

Wire Size: .5 – 1 mm²

[All ROUND CONNECTOR SYSTEM, PIN AND SOCKET \(60\)](#)

Features

Product Type Features

Receptacle Style	180°
Sealable	No
Primary Locking Feature	Locking Lance

Contact Features

Contact Size	2.5mm
Contact Fabrication	Stamped & Formed
Wire Contact Termination Area Plating Material	Tin
Typical Current Rating	40 A
Crimp Type	F-Crimp
Terminal Type	Pin
Mating Pin Diameter	2.5 mm[.098 in]
Interface Plating	Tin (Sn)

Termination Features

Termination Method to Wire & Cable	Crimp
Product Terminates To	Wire

Dimensions

Compatible Insulation Diameter Range	1.4 – 2.1 mm[.055 – .082 in]
Wire Size	.5 – 1 mm ²



Wire Size Search	17 AWG, 18 AWG, 19 AWG, 20 AWG
------------------	--------------------------------

Usage Conditions

Insulation Option	Uninsulated
Operating Temperature (Max)	80 °C, 85 °C, 90 °C, 100 °C, 105 °C, 110 °C, 120 °C, 125 °C, 130 °C[176 °F][185 °F][194 °F][212 °F][221 °F][230 °F][248 °F][257 °F][266 °F]
Operating Temperature Range	-40 – 130 °C[-40 – 266 °F]

Operation/Application

Compatible With Wire Base Material	Copper
------------------------------------	--------

Packaging Features

Packaging Quantity	3500
Packaging Method	Reel

Other

Terminal Transmits	25 – 40 A (Power)
--------------------	-------------------

Product Compliance

[For compliance documentation, visit the product page on TE.com>](#)

EU RoHS Directive 2011/65/EU	Compliant
EU ELV Directive 2000/53/EC	Compliant
China RoHS 2 Directive MIIT Order No 32, 2016	No Restricted Materials Above Threshold
EU REACH Regulation (EC) No. 1907/2006	Current ECHA Candidate List: JUNE 2023 (235) Candidate List Declared Against: JUNE 2023 (235) Does not contain REACH SVHC
Halogen Content	Low Halogen - Br, Cl, F, I < 900 ppm per homogenous material. Also BFR/CFR/PVC Free
Solder Process Capability	Not applicable for solder process capability

Product Compliance Disclaimer

This information is provided based on reasonable inquiry of our suppliers and represents our current actual knowledge based on the information they provided. This information is subject to change. The part numbers that TE has identified as EU RoHS compliant have a maximum concentration of 0.1% by weight in homogenous materials for lead, hexavalent chromium, mercury, PBB, PBDE, DBP, BBP, DEHP, DIBP, and 0.01% for cadmium, or qualify for an exemption to these limits as defined in the Annexes of Directive 2011/65/EU (RoHS2). Finished electrical and electronic equipment products will be CE marked as required by Directive 2011/65/EU. Components may not be CE marked. Additionally, the part numbers that TE has identified as EU ELV compliant have a maximum concentration of 0.1% by weight in homogenous materials for lead, hexavalent chromium, and mercury, and 0.01% for cadmium, or qualify for an exemption to these limits

as defined in the Annexes of Directive 2000/53/EC (ELV). Regarding the REACH Regulation, the information TE provides on SVHC in articles for this part number is based on the latest European Chemicals Agency (ECHA) 'Guidance on requirements for substances in articles' posted at this URL: <https://echa.europa.eu/guidance-documents/guidance-on-reach>

Compatible Parts



TE Part # 1-1579007-8
EXTRACTION TOOL



TE Part # 2-1579024-5
HAND TOOL 2,5 MM DIA.
CONTACTS 0,5-1,0



TE Part # 2305570-1
Strip Terminal Cutter-Side Feed-No
Crimp



TE Part # 2-2266254-1
OCEAN-2.0-APPLICATOR-S-080F1000



TE Part # 2-2266254-2
OCEAN-2.0-APPLICATOR-S-080F1000



TE Part # 2266254-1
OCEAN-2.0-APPLICATOR-S-080F1000



TE Part # 2266254-2
OCEAN-2.0-APPLICATOR-S-080F1000



TE Part # 2837603-1
APPLICATOR TO MAKE LOOSE
PIECE TERMINALS



TE Part # 7-2266254-1
OCEAN-2.0-APPLICATOR-S-080F1000



TE Part # 7-2266254-2
OCEAN-2.0-APPLICATOR-S-080F1000



TE Part # 7-2266254-7
OCEAN_2.0_SPARE_PART_KIT-
080F1000



TE Part # 7-2837603-7
TOOLING KIT TO MAKE LOOSE
PIECE TERMINAL

Also in the Series | Round Connector System



Automotive Connector Caps & Covers
(4)



Automotive Housings(17)



Automotive Terminals(60)



Connector Seals & Cavity Plugs(3)



Insertion & Extraction Tools(8)

Customers Also Bought



TE Part #7-968975-1
AMP MCP Unsealed Connector
Housings



TE Part #1-1393122-6
KHAU-11D12-12=KH



TE Part #1241374-2
AMP MCP, RECEPTACLE AND TAB

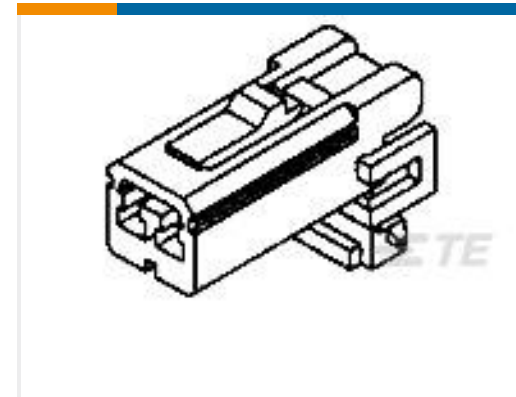

TE Part #174463-7
070 MLC PLUG HSG 2P YELLOW



TE Part #1740315-1
NECTOR S COVER FOR
DISTRIBUTOR 6,7 POS



TE Part #1740335-1
MICRO QUADLOK SYSTEM PIN
CONTA



TE Part #2819647-1
DT06-4S-CE13



TE Part #6-1393234-8
RP421024

Documents

Product Drawings

[STIFTKONTAKT 2,5MMD](#)

English

[STIFTKONTAKT 2,5MMD](#)

German

CAD Files

Customer View Model

[ENG_CVM_929963-1_A2.3d_igs.zip](#)

English

Customer View Model

[ENG_CVM_929963-1_A2.3d_stp.zip](#)

English

Customer View Model

[ENG_CVM_929963-1_A2.2d_dxf.zip](#)

English

[3D PDF](#)



English

By downloading the CAD file I accept and agree to the [Terms and Conditions](#) of use.

Datasheets & Catalog Pages

[Heavy Duty Connectors](#)

English

[CONNECTOR SELECTOR](#)

English

Product Specifications

[Application Specification](#)

English

[Application Specification](#)

English