



## Switching Diode Array Steering Diode TVS Array™

### DESCRIPTION

These low capacitance diode arrays are multiple, discrete, isolated junctions fabricated by a planar process and mounted in a 14-Pin SOIC package for use as steering diodes protecting up to eight I/O ports from ESD, EFT, or surge by directing them either to the positive side of the power supply line or to ground (see [Figure 1](#)). An external TVS diode may be added between the positive supply line and ground to prevent overvoltage on the supply rail. They may also be used in fast switching core-driver applications. This includes computers and peripheral equipment such as magnetic cores, thin-film memories, plated-wire memories, etc., as well as decoding or encoding applications. These arrays offer many advantages of integrated circuits such as high-density packaging and improved reliability. This is a result of fewer pick and place operations, smaller footprint, smaller weight, and elimination of various discrete packages that may not be as user friendly in PC board mounting. They are available with either tin-lead plating terminations or as RoHS compliant with annealed matte-tin finish.

**Important:** For the latest information, visit our website <http://www.microsemi.com>.

### FEATURES

- 16-diode array protects 8 lines
- Molded 14-Pin SOIC package
- UL 94V-0 flammability classification
- Low capacitance
- Switching speeds less than 5 ns
- IEC 61000-4 compatible:
  - 61000-4-2 (ESD): Air 15 kV, contact – 8 kV
  - 61000-4-4 (EFT): 40 A – 5/50 ns
  - 61000-4-5 (surge): 12 A, 8/20 μs
- RoHS compliant device is available

### APPLICATIONS / BENEFITS

- Protection from switching transients and induced RF
- Low capacitance steering diode protection for high frequency data lines
- Ideal for:
  - RS-232 & RS-422 Interface Networks.
  - Ethernet: 10 Base T
  - Computer I / O Ports
  - LAN
  - Switching Core Drivers

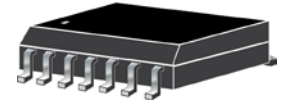

**14-Pin Package**

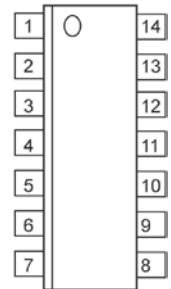

**Top Viewing Pin Layout**

**MSC – Lawrence**

6 Lake Street,  
Lawrence, MA 01841  
Tel: 1-800-446-1158 or  
(978) 620-2600  
Fax: (978) 689-0803

**MSC – Ireland**

Gort Road Business Park,  
Ennis, Co. Clare, Ireland  
Tel: +353 (0) 65 6840044  
Fax: +353 (0) 65 6822298

**Website:**

[www.microsemi.com](http://www.microsemi.com)

**MAXIMUM RATINGS**

Parameters/Test Conditions	Symbol	Value	Unit
Junction and Storage Temperature	$T_J$ and $T_{STG}$	-55 to +150	°C/W
Peak Working Reverse Voltage	$V_{RWM}$	75	V
Repetitive Peak Forward Current (one diode)	$I_{FRM}$	400	mA
Forward Surge Current	@ 8.3 ms	2	A
	@ 8/20 $\mu$ s	12	
Rated Average Power Dissipation (total package)	$P_{M(AV)}$	1500	mW
Solder Temperature @ 10 s		260	°C

**MECHANICAL and PACKAGING**

- CASE: Void-free transfer molded thermosetting epoxy body meeting UL94V-0 flammability classification.
- TERMINALS: Tin-lead or RoHS compliant annealed matte-tin plating solderable per MIL-STD-750 method 2026.
- MARKING: MSC logo, MMAD1103 or MMAD1103e3 and date code. Pin #1 is to the left of the dot or indent on top of package.
- DELIVERY option: Tape and reel or carrier tube. Consult factory for quantities.
- WEIGHT: Approximately 0.127 grams
- See [Package Dimensions](#) on last page.

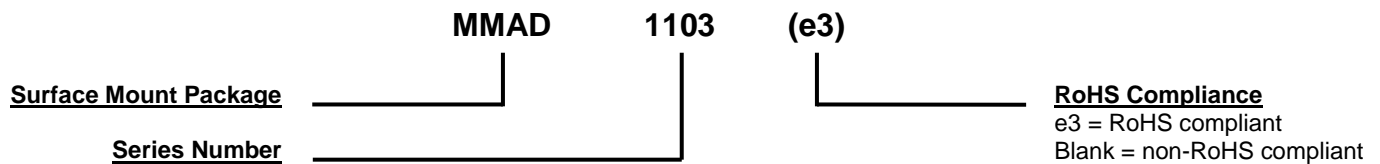
**PART NOMENCLATURE**

**SYMBOLS & DEFINITIONS**

Symbol	Definition
$C_T$	Total Capacitance: The total small signal capacitance between the diode terminals of a complete device.
$I_R$	Maximum Leakage Current: The maximum leakage current that will flow at the specified voltage and temperature.
$V_{(BR)}$	Breakdown Voltage: The voltage across the device at a specified current $I_{(BR)}$ in the breakdown region.
$V_F$	Maximum Forward Voltage: The maximum forward voltage the device will exhibit at a specified current.
$V_{RWM}$	Working Peak Reverse Voltage: The maximum peak voltage that can be applied over the operating temperature range.

**ELECTRICAL CHARACTERISTICS @ 25 °C unless otherwise stated**

PART NUMBER	BREAKDOWN VOLTAGE	LEAKAGE CURRENT		LEAKAGE CURRENT		TOTAL CAPACITANCE	REVERSE RECOVERY TIME	FORWARD VOLTAGE	FORWARD VOLTAGE
	$V_{(BR)}$	$I_R$	$I_R$	$I_R$	$I_R$	$C_T$	$t_{rr}$	$V_F$	$V_F$
	@ $I_{BR} = 100 \mu A$	$T_A = 25 \text{ }^\circ C$	$T_A = 150 \text{ }^\circ C$	$T_A = 150 \text{ }^\circ C$	$T_A = 150 \text{ }^\circ C$	@ 0 V		$I_F = 10 \text{ mA}$	$I_F = 100 \text{ mA}$
	V	$\mu A$	$\mu A$	$\mu A$	$\mu A$	pF	ns	V	V
	MIN	MAX	@ $V_R$	MAX	@ $V_R$	TYP (Note 1)	MAX	MAX	MAX
MMAD1103 MMAD1103e3	90	0.200	20	300	20	1.5	5.0	1.00	1.20

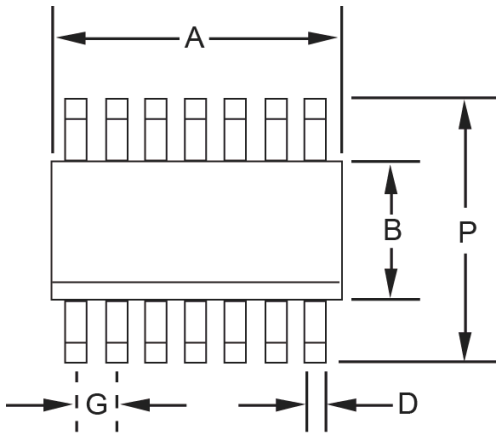
**NOTE 1:** Individual diode capacitance is less than 1.5 pF but will read higher between pins with the connected parallel diode array shown.

**PACKAGE DIMENSIONS**

Ref.	Dimensions			
	Inch		Millimeters	
	Min	Max	Min	Max
A	0.336	0.344	8.53	8.74
B	0.150	0.158	3.81	4.01
C	0.053	0.069	1.35	1.75
D	0.011	0.021	0.28	0.53
F	0.016	0.050	0.41	1.27
G	0.050 BSC		1.27 BSC	
J	0.006	0.010	0.15	0.25
K	0.004	0.008	0.10	0.20
L	0.189	0.206	4.80	5.23
P	0.228	0.244	5.79	6.19

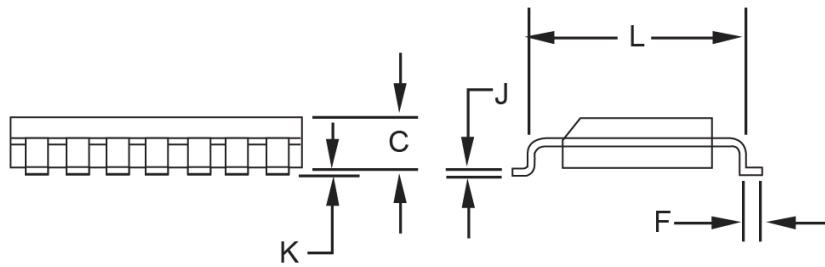
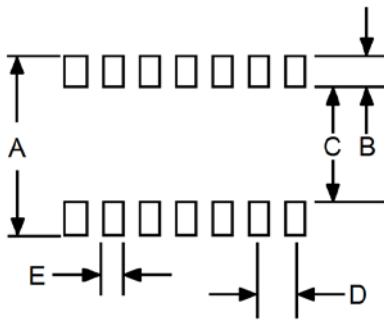
**PAD LAYOUT**

Ref.	Dimensions	
	Inch	Millimeters
	Typical	Typical
A	0.275	6.99
B	0.060	1.52
C	0.144	3.94
D	0.050	1.27
E	0.024	0.61

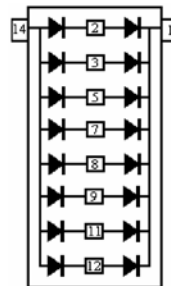
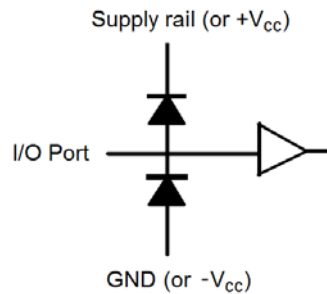
**SCHEMATIC AND CIRCUIT**

**Figure 1**

# Mouser Electronics

Authorized Distributor

Click to View Pricing, Inventory, Delivery & Lifecycle Information:

[Microchip:](#)

[MMAD1103e3/TR13](#) [MMAD1103/TR13](#)