

Features

- Transient Voltage Suppression (TVS) protection of one line
- Max. peak pulse power: $P_{PP} = 890 \text{ W}$
- Low clamping voltage: $V_{CL} = 19 \text{ V}$
- Low leakage current: $I_{RM} = 300 \text{ nA}$
- ESD protection up to 30 kV
- IEC 61000-4-2; level 4 (ESD)
- IEC 61000-4-5 (surge); $I_{PP} = 47 \text{ A}$
- AEC-Q101 qualified

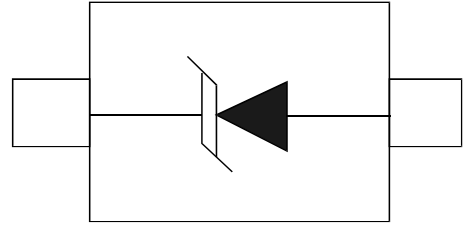

Applications

- Computers and peripherals
- Audio and video equipment
- Cellular handsets and accessories
- Communication systems
- Portable electronics
- Medical and industrial equipment

Mechanical Data

- SOD-323 package
- Molding compound flammability rating: UL94V-0
- Packaging: Tape and Reel
- RoHS/WEEE Compliant

Quick reference data

Table 2. Quick reference data
 $T_{amb} = 25 \text{ }^\circ\text{C}$ unless otherwise specified.

Symbol	Parameter	Conditions	Min	Typ	Max	Unit
V_{RWM}	reverse standoff voltage		-	-	12	V
C_d	diode capacitance	$f = 1 \text{ MHz}; V_R = 0 \text{ V}$	-	160	180	pF

Limiting values

Limiting values

In accordance with the Absolute Maximum Rating System (IEC 60134).

Symbol	Parameter	Conditions		Min	Max	Unit
P _{PP}	peak pulse power	t _p = 8/20 μs	[1][2]	-	600	W
I _{PP}	peak pulse current	t _p = 8/20 μs	[1][2]	-	22.5	A

Limiting values ...continued

In accordance with the Absolute Maximum Rating System (IEC 60134).

Symbol	Parameter	Conditions		Min	Max	Unit
P _{tot}	total power dissipation	T _{amb} ≤ 25 °C	[3]	-	360	mW
			[4]	-	500	mW
T _j	junction temperature			-	150	°C
T _{amb}	ambient temperature			-55	+150	°C
T _{stg}	storage temperature			-65	+150	°C

[1] Non-repetitive current pulse 8/20 μs exponential decay waveform according to IEC 61000-4-5.

[2] Soldering point of cathode tab.

[3] Device mounted on an FR4 Printed-Circuit Board (PCB), single-sided copper, tin-plated and standard footprint.

[4] Device mounted on an FR4 PCB, single-sided copper, tin-plated, mounting pad for cathode 1 cm².

ESD maximum ratings

T_{amb} = 25 °C unless otherwise specified.

Symbol	Parameter	Conditions		Min	Max	Unit
V _{ESD}	electrostatic discharge voltage	IEC 61000-4-2 (contact discharge)	[1]	-	30	kV
		machine model		-	400	V

[1] Device stressed with ten non-repetitive ESD pulses.

ESD standards compliance

Standard	Conditions
IEC 61000-4-2; level 4 (ESD)	> 15 kV (air); > 8 kV (contact)
MIL-STD-883; class 3 (human body model)	> 4 kV

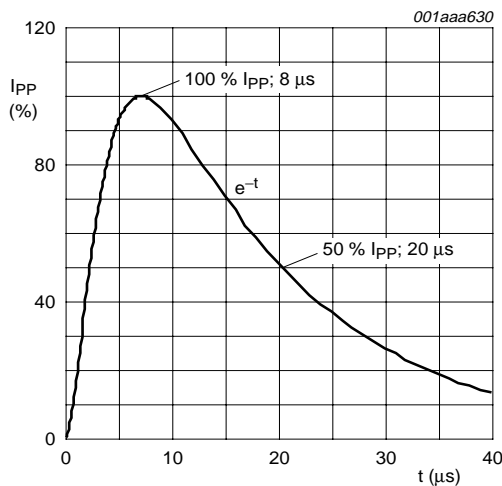

8/20 μs pulse waveform according to IEC 61000-4-5

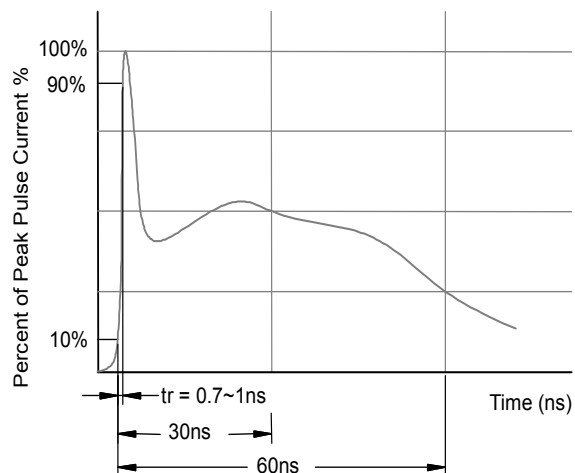

ESD pulse waveform according to IEC 61000-4-2

Characteristics

Characteristics

T_{amb} = 25 °C unless otherwise specified.

Symbol	Parameter	Conditions	Min	Typ	Max	Unit
V _{RWM}	reverse standoff voltage		-	-	12	V
I _{RM}	reverse leakage current	V _{RWM} = 12 V	-	<1	0.1	μA
V _{BR}	breakdown voltage	I _R = 5 mA	13.3	14.5	17.75	V
C _d	diode capacitance	f = 1 MHz; V _R = 0 V	-	160	180	pF
V _{CL}	clamping voltage	I _{PP} = 47 A	[1]	-	27	V
		I _{PP} = 25 A	-	-	23.5	V
		I _{PP} = 5 A	-	-	19	V
r _{dif}	differential resistance	I _R = 5 mA	-	2	100	Ω

[1] Non-repetitive current pulse 8/20 μs exponential decay waveform according to IEC 61000-4-5.

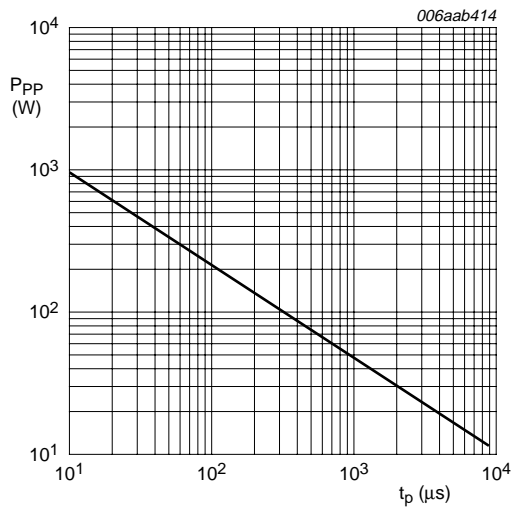

Peak pulse power as a function of exponential pulse duration; typical values

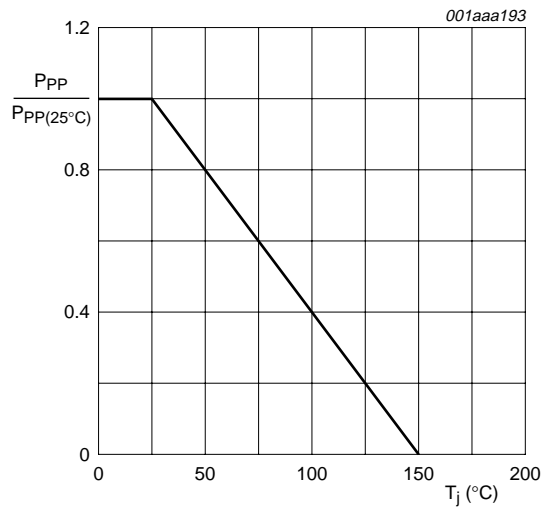

Relative variation of peak pulse power as a function of junction temperature; typical values

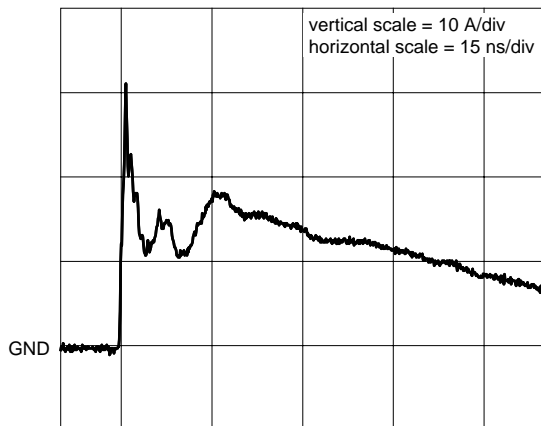

unclamped +8 kV ESD pulse waveform (IEC 61000-4-2 network)

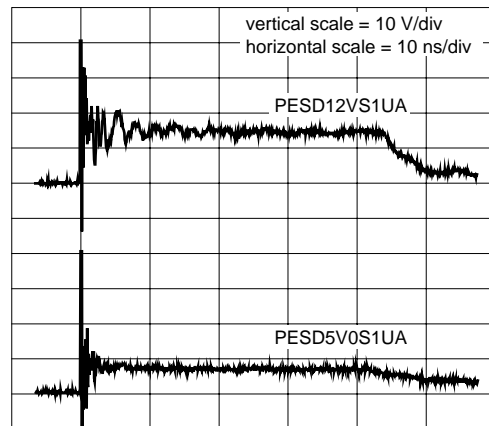

clamped +8 kV ESD pulse waveform (IEC 61000-4-2 network)

Outline Drawing – SOD-323

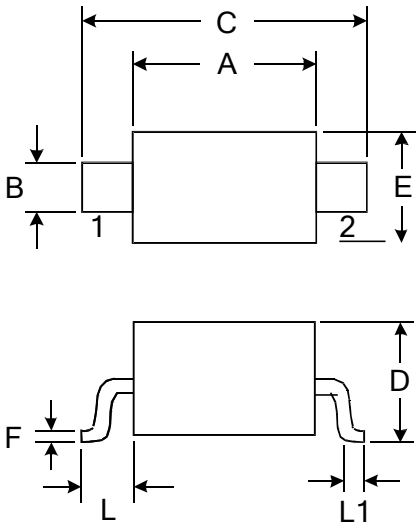

SYMBOL	DIMENSIONS			
	MILLIMETER		INCHES	
	MIN	MAX	MIN	MAX
A	1.600	1.800	0.063	0.071
B	0.250	0.350	0.010	0.014
C	2.500	2.700	0.098	0.106
D		1.000		0.039
E	1.200	1.400	0.047	0.055
F	0.080	0.150	0.003	0.006
L	0.475 REF		0.019REF	
L1	0.250	0.400	0.010	0.016
H	0.000	0.100	0.000	0.004

Marking



Ordering information

Order code	Package	Baseqty	Deliverymode
UMW PESD12VS1UA	SOD-323	3000	Tape and reel