

LOC		DIST		REVISIONS			
P	LTR	DESCRIPTION	DATE	DWN	APVD		
E		REVISED PER ECR-21-100678	08APR2021	SS	VS		
F		REVISED PER ECR-20-100915	28APR2021	JP	VS		

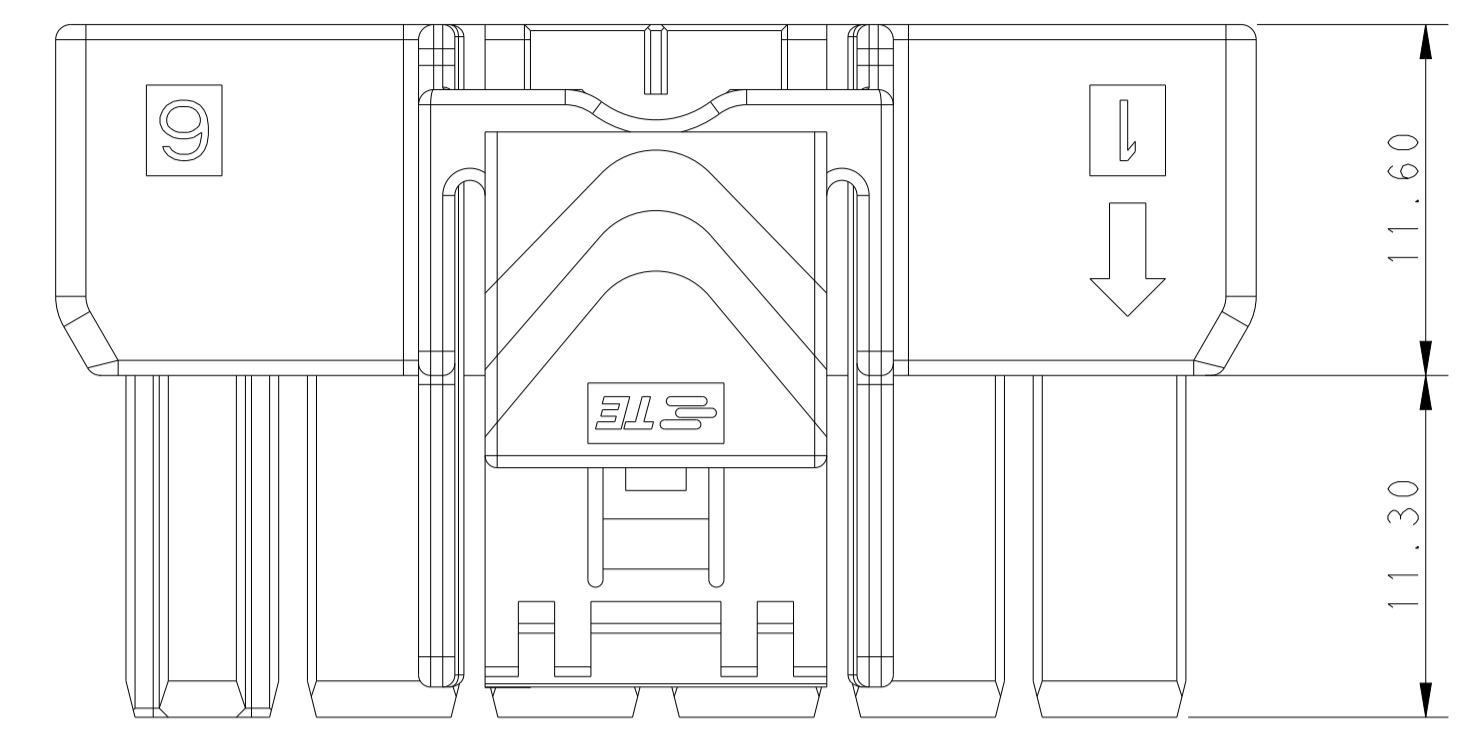

POS.	DIM. A
2*6	39.70
2*5	33.70
2*4	27.70
2*3	21.70

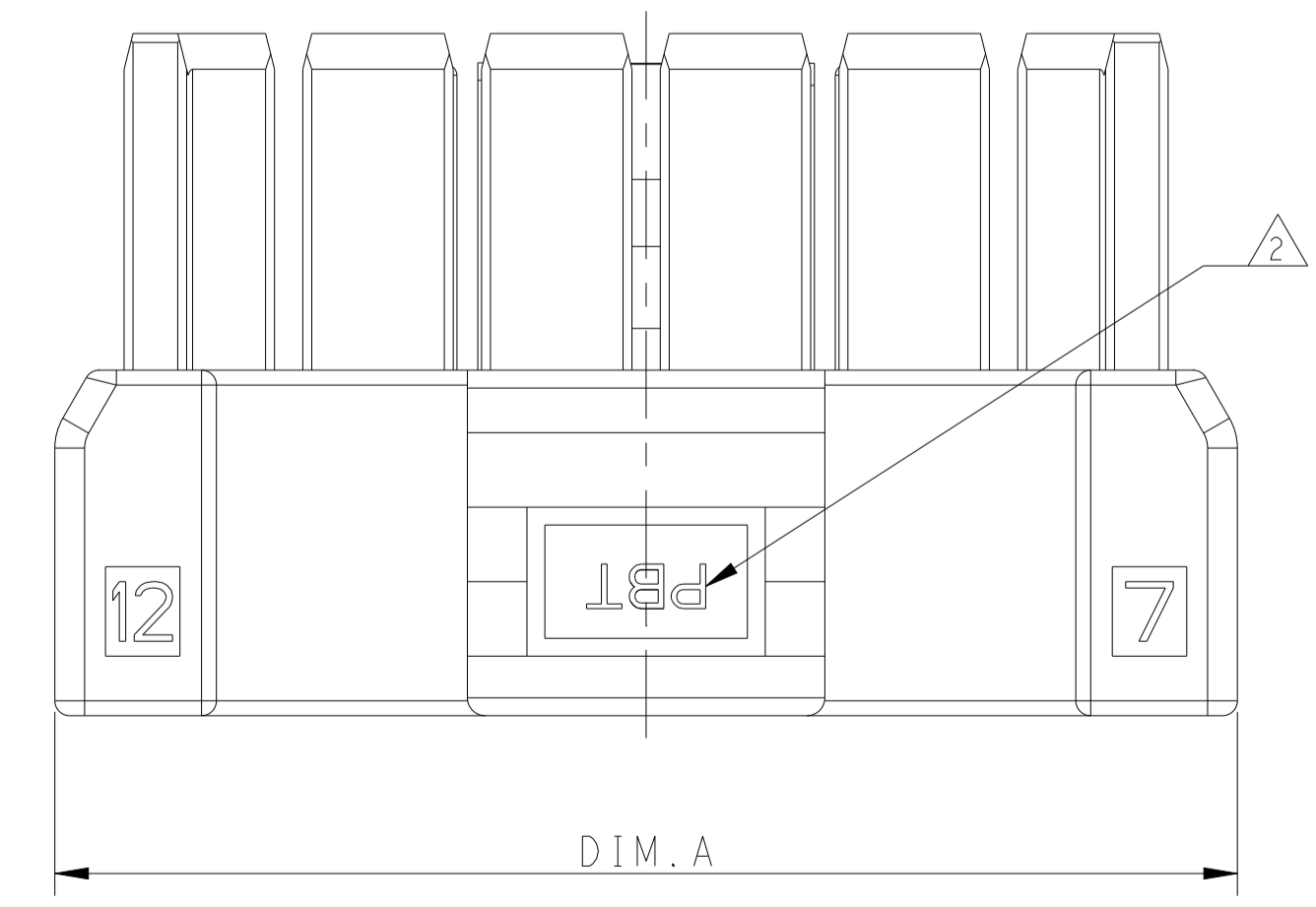
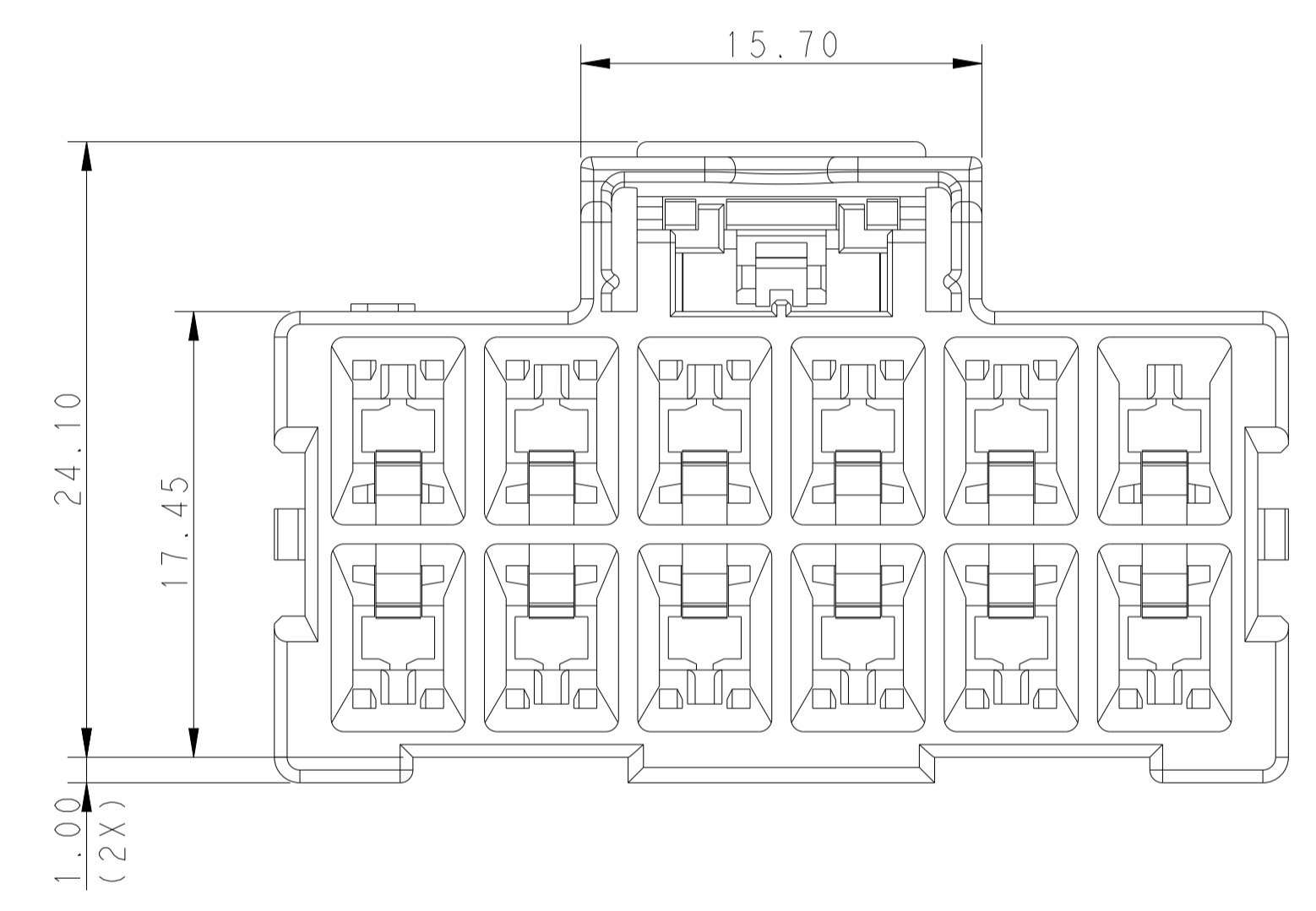
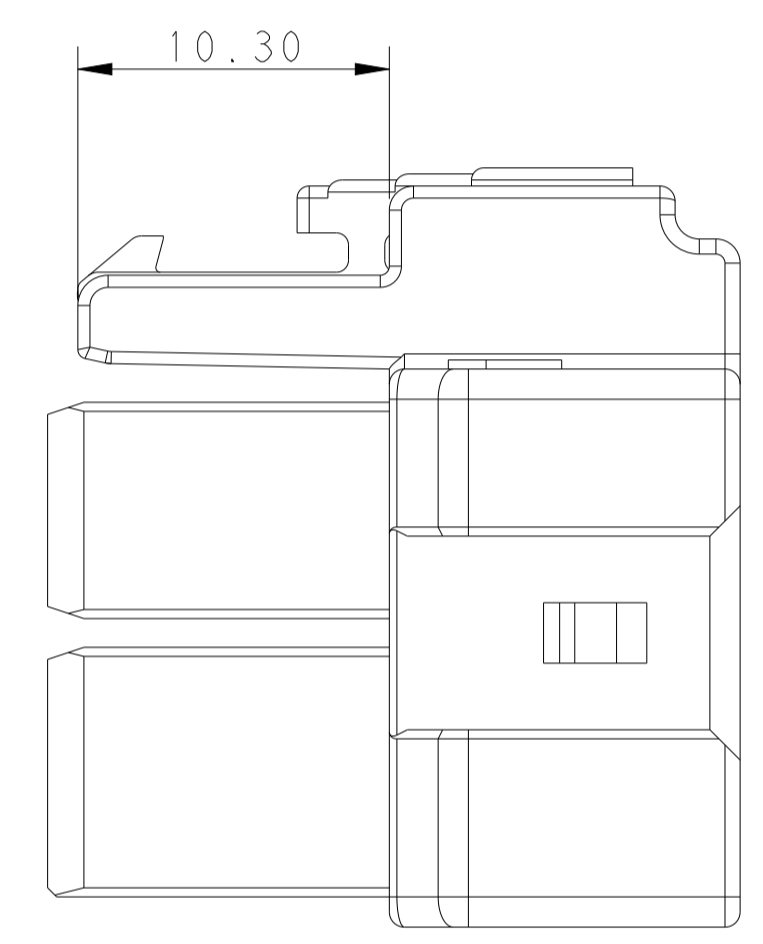
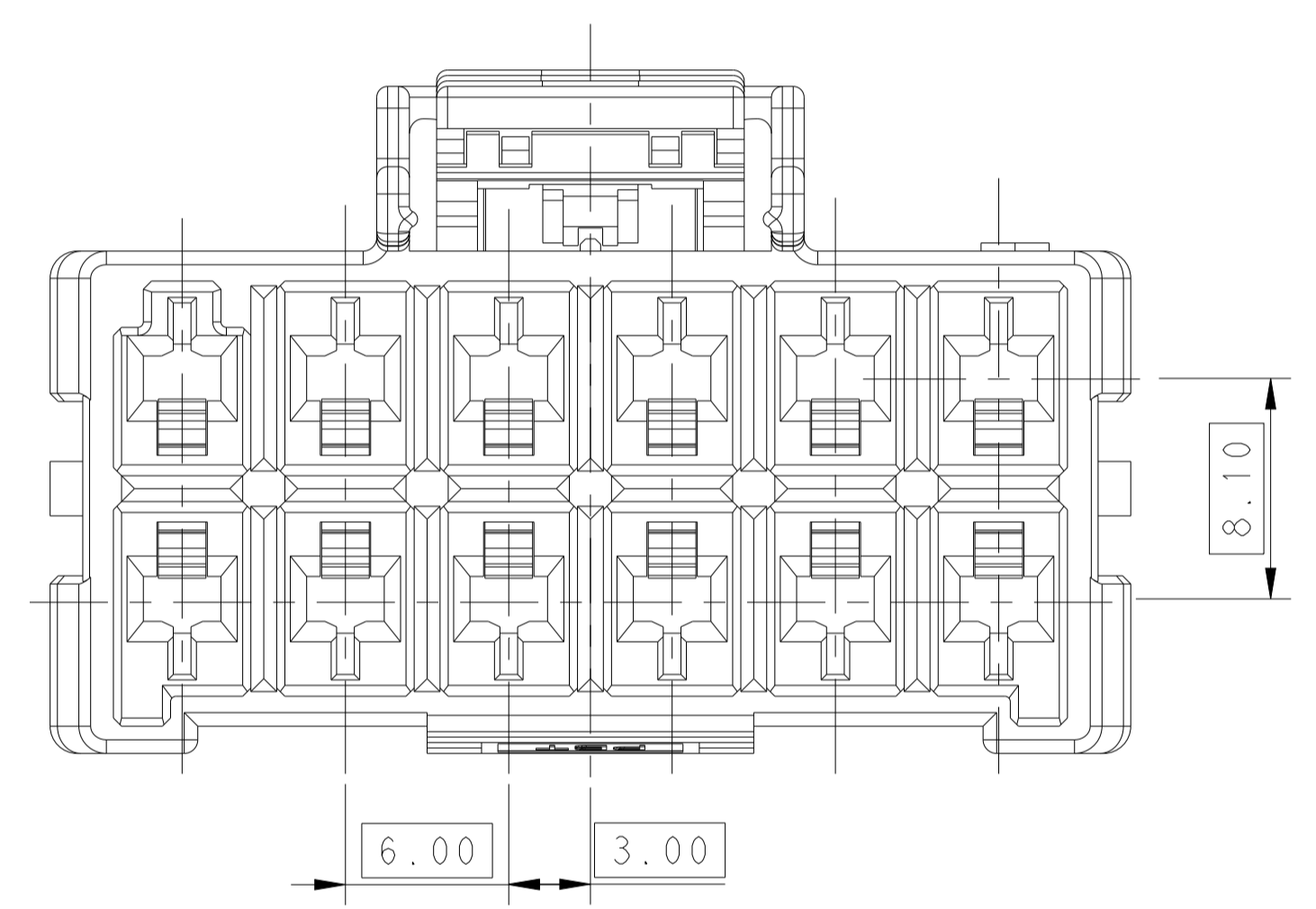

1 MATERIAL:  
 LEVEL 1: PBT, STANDARD TEMPERATURE 105°C  
 KEY A: NATURAL; KEY B: PURPLE; KEY C: BLUE; KEY D: YELLOW  
 LEVEL 2: PA66, HIGH TEMPERATURE 150°C  
 KEY A: LIGHT GREY; KEY B: RED; KEY C: BLACK; KEY D: NATURAL

2 MATERIAL MARK:  
 LEVEL 1: PBT, LEVEL 2: HDT  
 3. APPLICABLE CONTACT P/N  
 RECEPTACLE CONTACT: 1971237/1971779/81/83/85/87-\*, 2238066-\*

4. MATING CONN, P/N  
 CAP HSG: \*-1971774/5-  
 TPA (LOCKING PLATE): \*-1971778-\*

5 GLOW WIRE COMPLIANT IN ACCORDANCE WITH IEC 60335-1. THIS IS BASED ON THE PRODUCT MEETING A GWEPT 850° C TEST AND RESIN GWIT GREATER THAN OR EQUAL TO 775° C.

THIS DRAWING IS A CONTROLLED DOCUMENT.		DWN: TOMMY WU 09JUL2012	TE Connectivity PLUG HOUSING, DOUBLE ROW POWER TRIPLE LOCK
DIMENSIONS: mm		CHK: HAPYE WU 09JUL2012	
TOLERANCES UNLESS OTHERWISE SPECIFIED:		APVD: YUHONG MAO 09JUL2012	
0 PLC ± 1 PLC ±0.35 2 PLC ±0.25 3 PLC ± 4 PLC ± ANGLES ± FINISH -		PRODUCT SPEC: 108-106118 APPLICATION SPEC: 114-106118 WEIGHT: - Customer Drawing	
MATERIAL: 1		SIZE: A1 CAGE CODE: 00779 DRAWING NO: C=1971776 SCALE: 4:1 SHEET: 1 OF 2 REV: F	RESTRICTED TO: -

LOC		DIST		REVISIONS			
P	LTN	DESCRIPTION	DATE	OWN	APVD		
-	-	SEE SHEET 1	-	-	-		

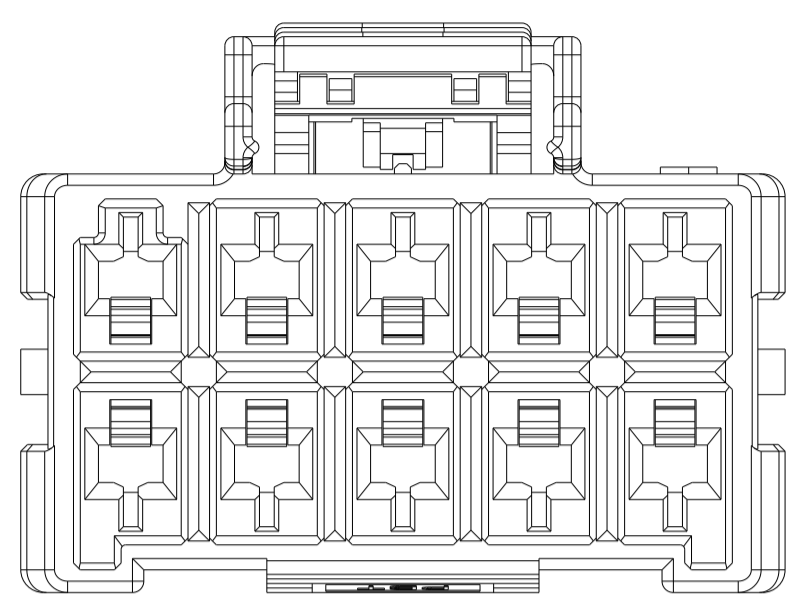
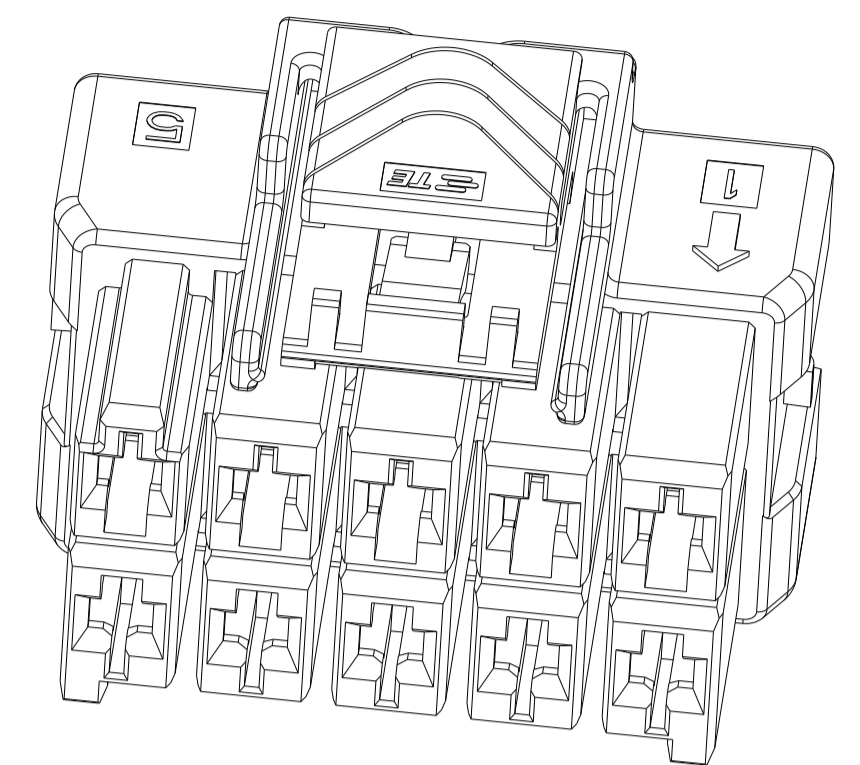

2\*5 POSITIONS

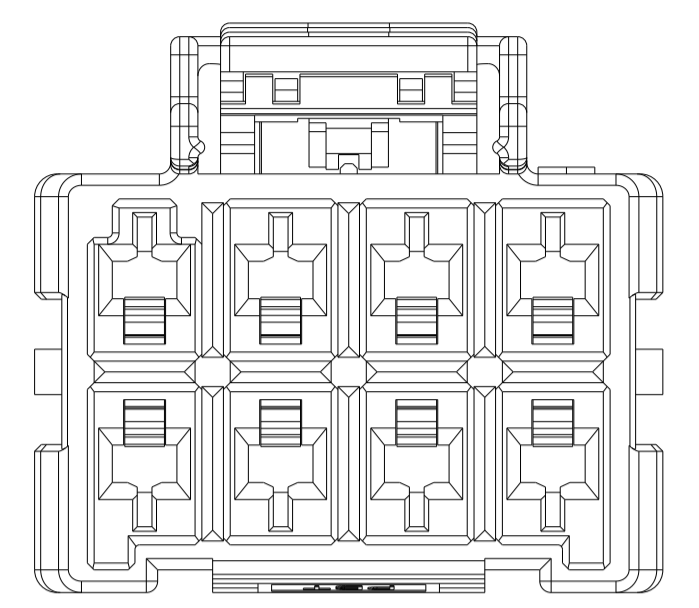
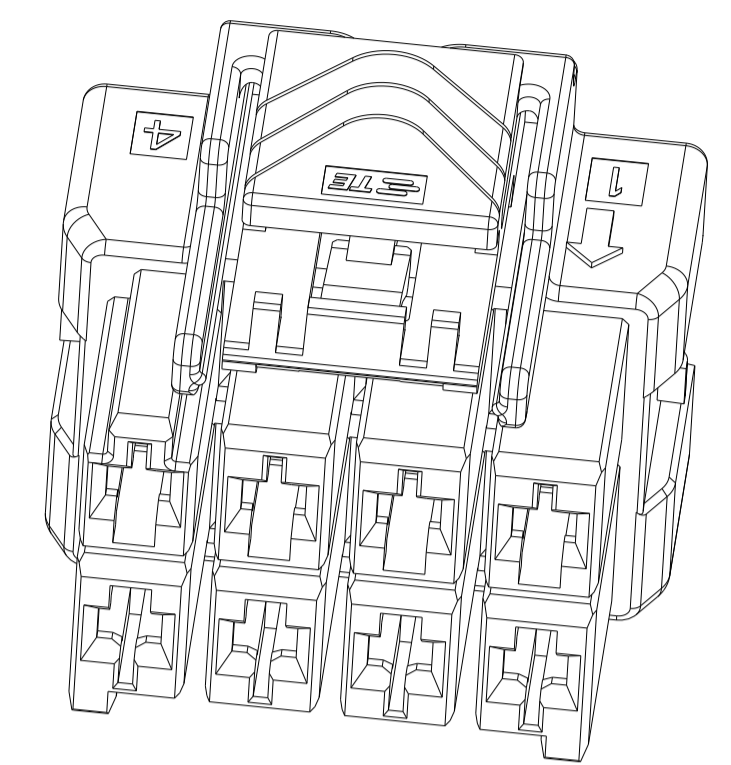

2\*4 POSITIONS

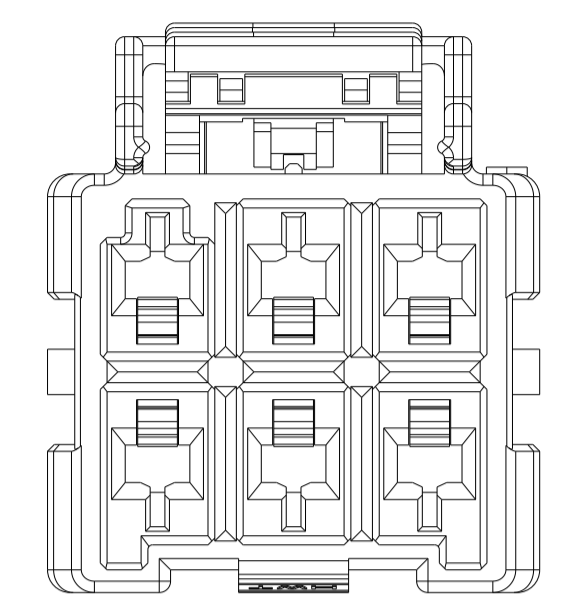
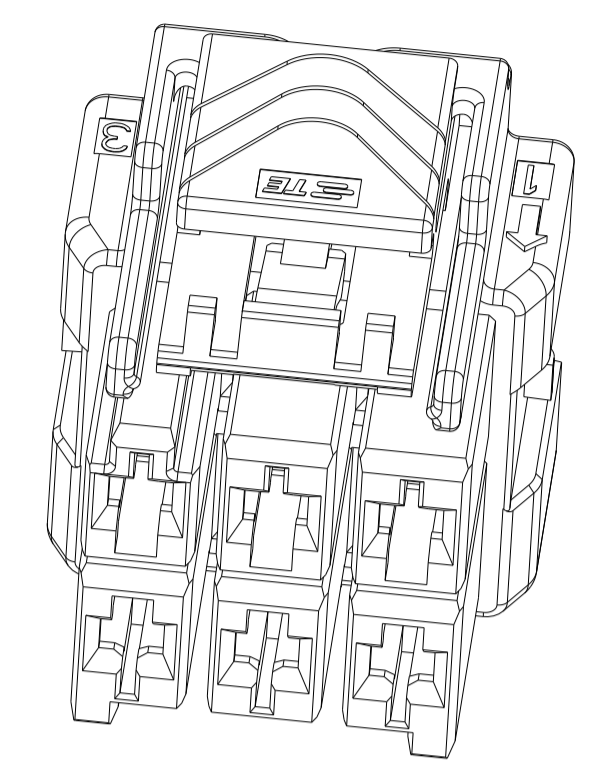

2\*3 POSITIONS

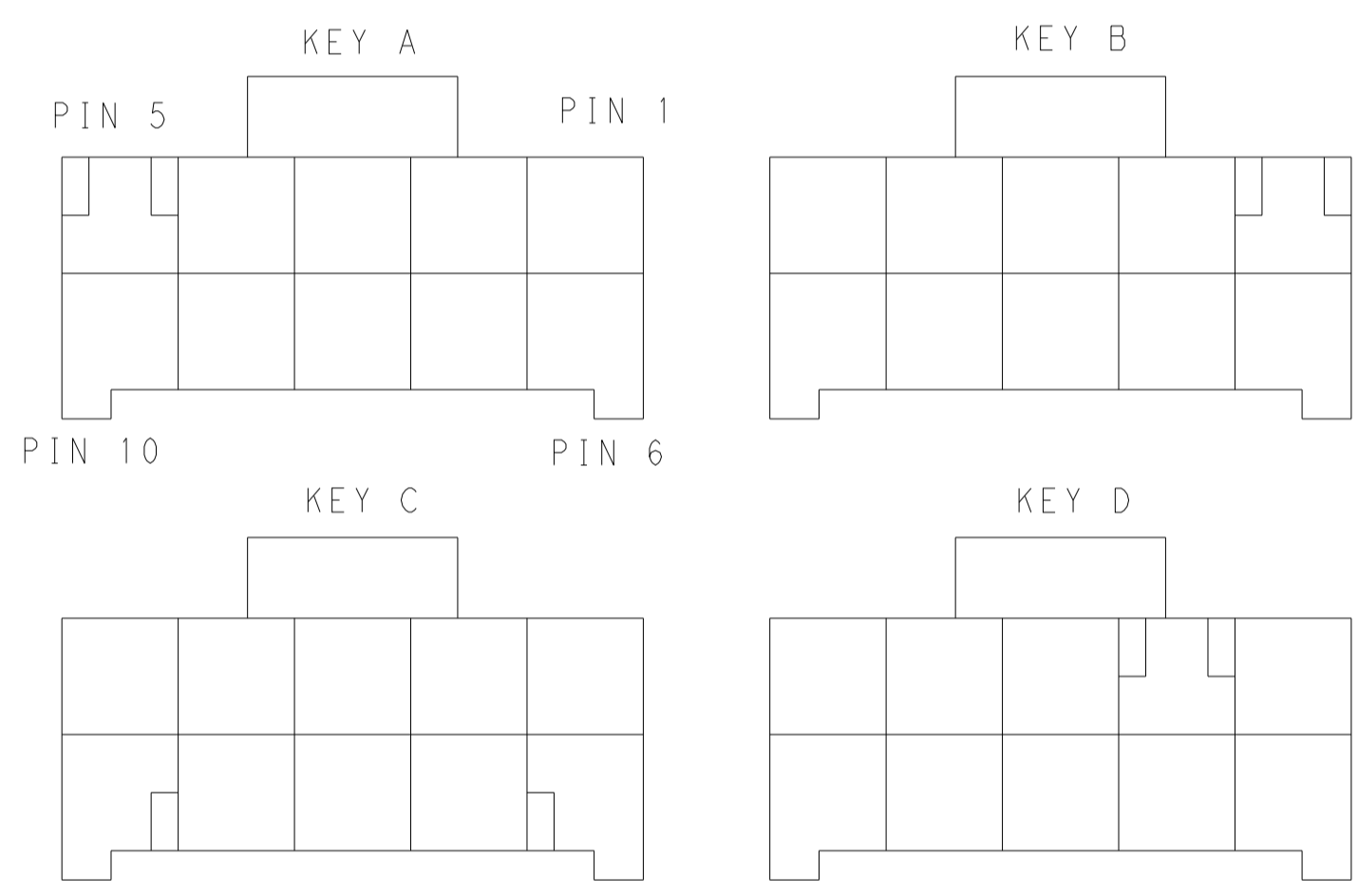

KEYING FOR 2\*5 POS.

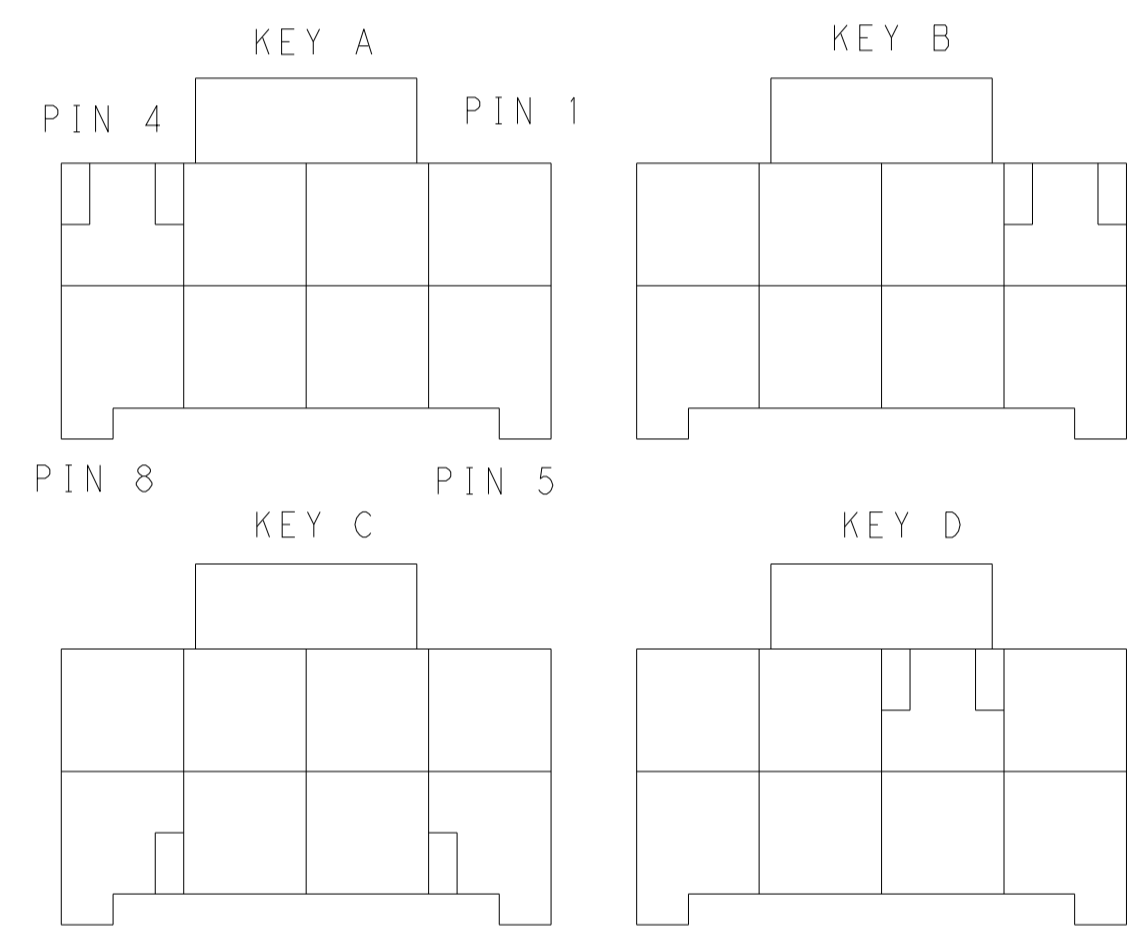

KEYING FOR 2\*4 POS.

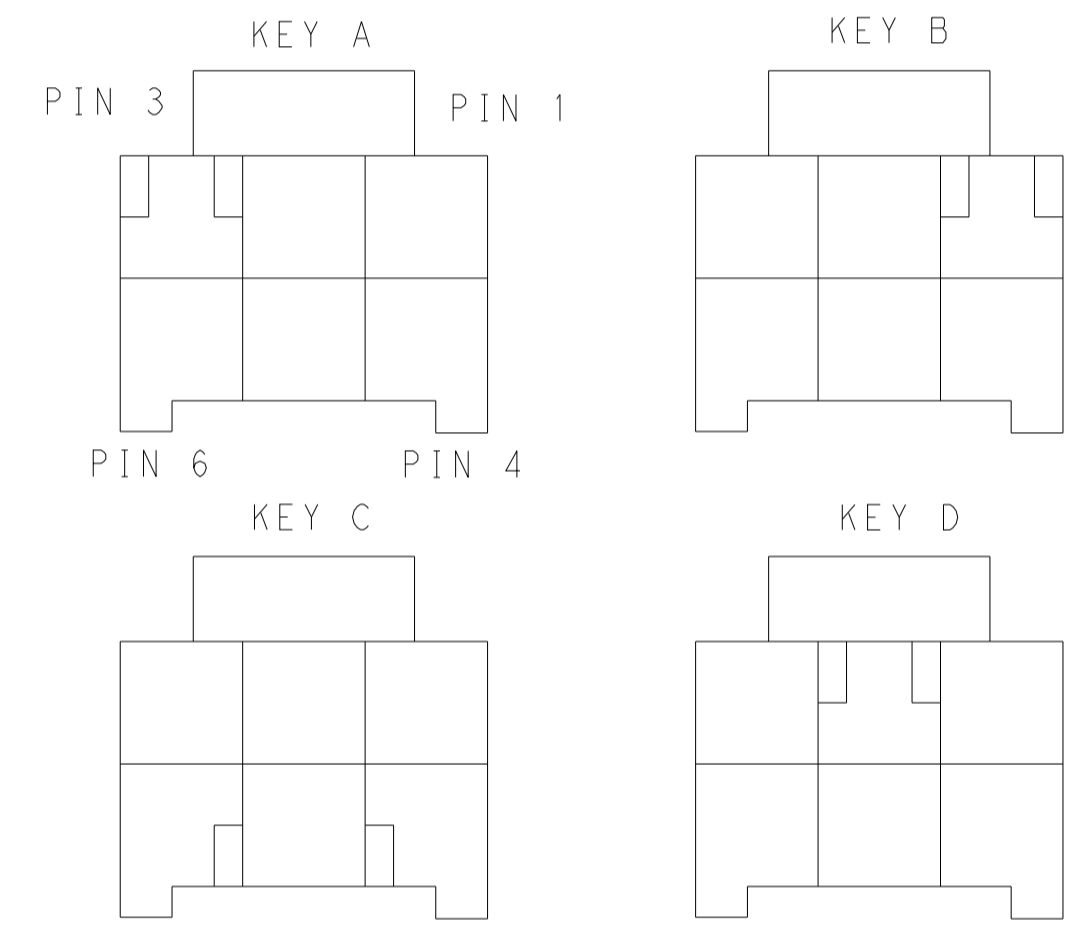

KEYING FOR 2\*3 POS.

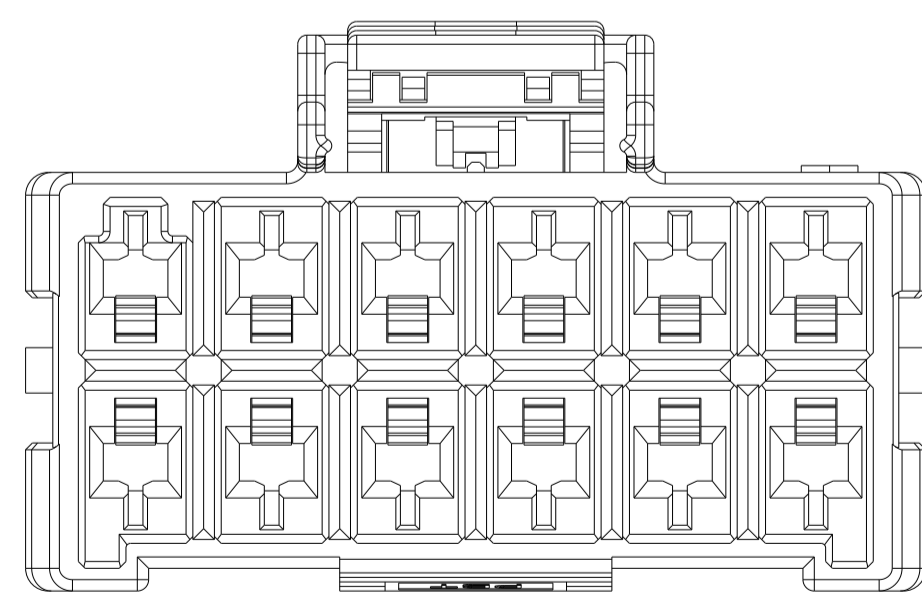
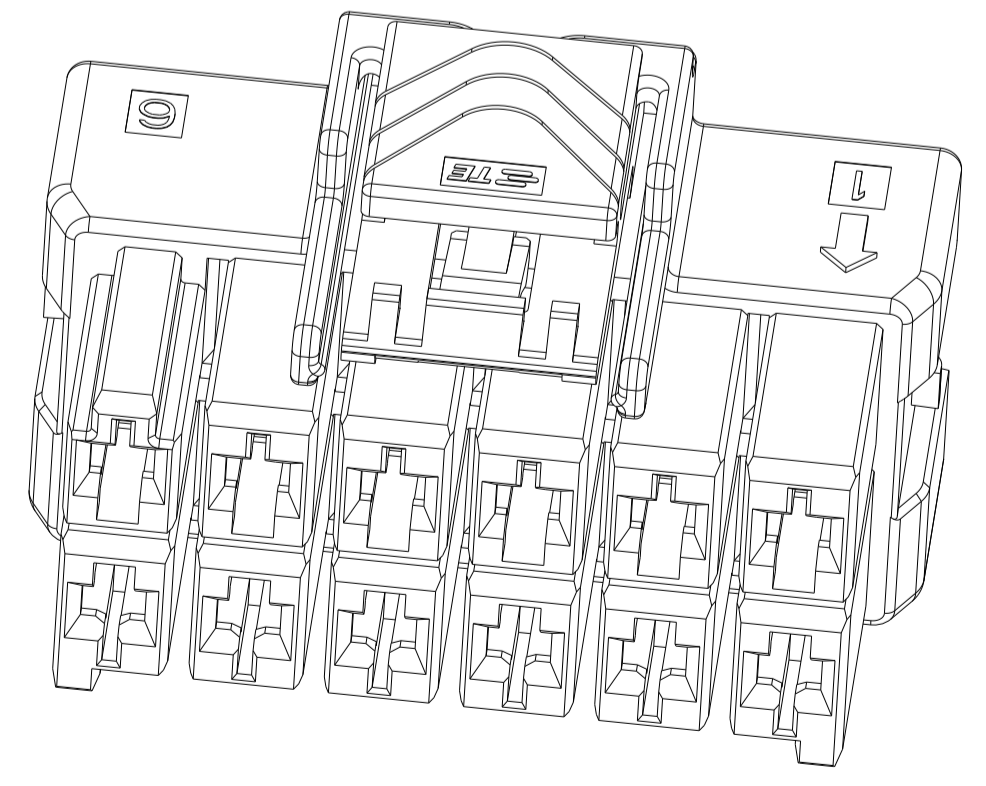

2\*6 POSITIONS

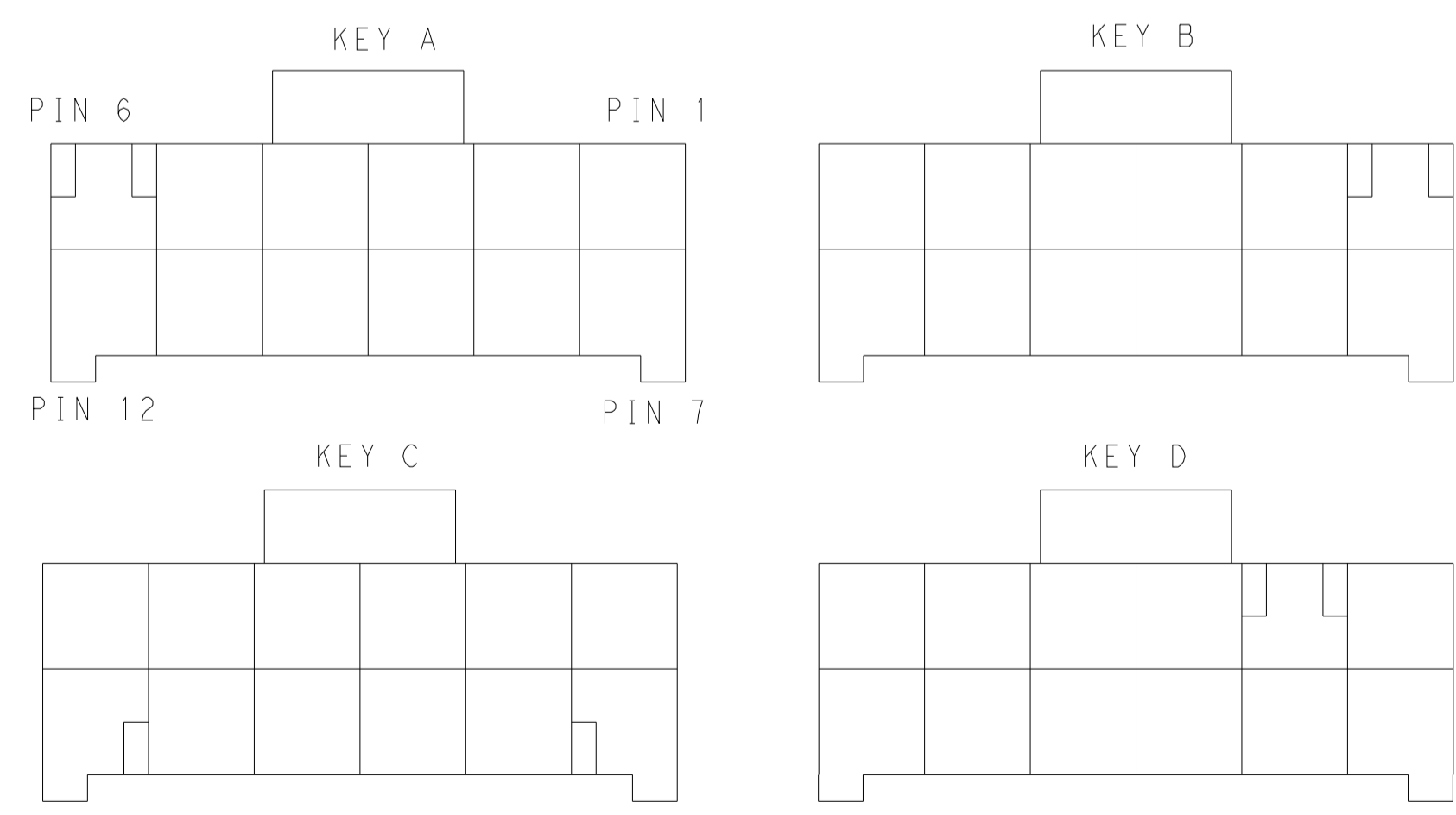

KEYING FOR 2\*6 POS.

POS.	MATERIAL	KEY	P/N
2*6	LEVEL 1	KEY A	1-1971776-6
		KEY B	2-1971776-6
		KEY C	3-1971776-6
		KEY D	4-1971776-6
2*6	LEVEL 2	KEY A	5-1971776-6
		KEY B	6-1971776-6
		KEY C	7-1971776-6
		KEY D	8-1971776-6
2*5	LEVEL 1	KEY A	1-1971776-5
		KEY B	2-1971776-5
		KEY C	3-1971776-5
		KEY D	4-1971776-5
2*5	LEVEL 2	KEY A	5-1971776-5
		KEY B	6-1971776-5
		KEY C	7-1971776-5
		KEY D	8-1971776-5

POS.	MATERIAL	KEY	P/N
2*4	LEVEL 1	KEY A	1-1971776-4
		KEY B	2-1971776-4
		KEY C	3-1971776-4
		KEY D	4-1971776-4
2*4	LEVEL 2	KEY A	5-1971776-4
		KEY B	6-1971776-4
		KEY C	7-1971776-4
		KEY D	8-1971776-4
2*3	LEVEL 1	KEY A	1-1971776-3
		KEY B	2-1971776-3
		KEY C	3-1971776-3
		KEY D	4-1971776-3
2*3	LEVEL 2	KEY A	5-1971776-3
		KEY B	6-1971776-3
		KEY C	7-1971776-3
		KEY D	8-1971776-3

THIS DRAWING IS A CONTROLLED DOCUMENT. DWG TOMMY WU 09JUL2012  
 CHK HAPYE WU 09JUL2012  
 APVD YUHONG MAO 09JUL2012

**STE** TE Connectivity

NAME: PLUG HOUSING, DOUBLE ROW POWER TRIPLE LOCK

PRODUCT SPEC: 108-106118  
 APPLICATION SPEC: 114-106118

SIZE: A1 CAGE CODE: 00779 DRAWING NO: 1971776  
 SHEET 2 OF 2 REV F

MATERIAL: . FINISH: . WEIGHT: . SCALE: 4:1

Customer Drawing

# Mouser Electronics

Authorized Distributor

Click to View Pricing, Inventory, Delivery & Lifecycle Information:

[TE Connectivity:](#)

[1-1971776-4](#)