

General Description

The AO3480 combines advanced trench MOSFET technology with a low resistance package to provide extremely low $R_{DS(ON)}$. This device is suitable for use as a load switch or in PWM applications.

Product Summary

V_{DS}	30V
I_D (at $V_{GS}=10V$)	5.7A
$R_{DS(ON)}$ (at $V_{GS}=10V$)	< 26.5m Ω
$R_{DS(ON)}$ (at $V_{GS} = 4.5V$)	< 32m Ω
$R_{DS(ON)}$ (at $V_{GS} = 2.5V$)	< 50m Ω

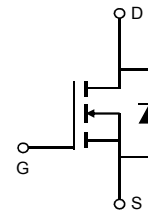
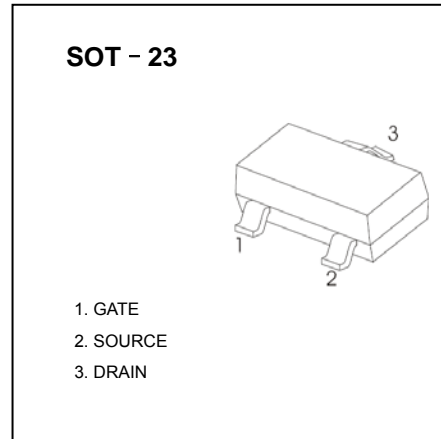

Absolute Maximum Ratings $T_A=25^\circ C$ unless otherwise noted

Parameter	Symbol	Maximum	Units
Drain-Source Voltage	V_{DS}	30	V
Gate-Source Voltage	V_{GS}	± 12	V
Continuous Drain Current	I_D	$T_A=25^\circ C$	5.7
		$T_A=70^\circ C$	4.7
Pulsed Drain Current ^C	I_{DM}	30	A
Power Dissipation ^B	P_D	$T_A=25^\circ C$	1.4
		$T_A=70^\circ C$	0.9
Junction and Storage Temperature Range	T_J, T_{STG}	-55 to 150	$^\circ C$

Thermal Characteristics					
Parameter		Symbol	Typ	Max	Units
Maximum Junction-to-Ambient ^A	$t \leq 10s$	$R_{\theta JA}$	70	90	$^\circ C/W$
Maximum Junction-to-Ambient ^{A,D}	Steady-State		100	125	$^\circ C/W$
Maximum Junction-to-Lead	Steady-State	$R_{\theta JL}$	63	80	$^\circ C/W$

Electrical Characteristics (T_J=25°C unless otherwise noted)

Symbol	Parameter	Conditions	Min	Typ	Max	Units
STATIC PARAMETERS						
BV _{DSS}	Drain-Source Breakdown Voltage	I _D =250μA, V _{GS} =0V	30			V
I _{DSS}	Zero Gate Voltage Drain Current	V _{DS} =30V, V _{GS} =0V T _J =55°C			1 5	μA
I _{GSS}	Gate-Body leakage current	V _{DS} =0V, V _{GS} = ±12V			100	nA
V _{GS(th)}	Gate Threshold Voltage	V _{DS} =V _{GS} , I _D =250μA	0.65	1.05	1.45	V
I _{D(ON)}	On state drain current	V _{GS} =4.5V, V _{DS} =5V	30			A
R _{DS(ON)}	Static Drain-Source On-Resistance	V _{GS} =10V, I _D =5.7A		18	26.5	mΩ
		V _{GS} =4.5V, I _D =5A		19	32	mΩ
		V _{GS} =2.5V, I _D =3A		24	50	mΩ
g _{FS}	Forward Transconductance	V _{DS} =5V, I _D =5.7A		33		S
V _{SD}	Diode Forward Voltage	I _S =1A, V _{GS} =0V		0.7	1	V
I _S	Maximum Body-Diode Continuous Current				2	A
DYNAMIC PARAMETERS						
C _{iss}	Input Capacitance	V _{GS} =0V, V _{DS} =15V, f=1MHz		630		pF
C _{oss}	Output Capacitance			75		pF
C _{rss}	Reverse Transfer Capacitance			50		pF
R _g	Gate resistance	V _{GS} =0V, V _{DS} =0V, f=1MHz	1.5	3	4.5	Ω
SWITCHING PARAMETERS						
Q _g	Total Gate Charge	V _{GS} =4.5V, V _{DS} =15V, I _D =5.7A		6	10	nC
Q _{gs}	Gate Source Charge			1.3		nC
Q _{gd}	Gate Drain Charge			1.8		nC
t _{D(on)}	Turn-On DelayTime	V _{GS} =10V, V _{DS} =15V, R _L =2.6Ω, R _{GEN} =3Ω		3		ns
t _r	Turn-On Rise Time			2.5		ns
t _{D(off)}	Turn-Off DelayTime			25		ns
t _f	Turn-Off Fall Time			4		ns
t _{rr}	Body Diode Reverse Recovery Time	I _F =5.7A, di/dt=100A/μs		8.5		ns
Q _{rr}	Body Diode Reverse Recovery Charge	I _F =5.7A, di/dt=100A/μs		2.6		nC

A. The value of R_{θJA} is measured with the device mounted on 1in² FR-4 board with 2oz. Copper, in a still air environment with T_A=25° C. The value in any given application depends on the user's specific board design.

B. The power dissipation P_D is based on T_{J(MAX)}=150° C, using ≤ 10s junction-to-ambient thermal resistance.

C. Repetitive rating, pulse width limited by junction temperature T_{J(MAX)}=150° C. Ratings are based on low frequency and duty cycles to keep initial T_J=25° C.

D. The R_{θJA} is the sum of the thermal impedance from junction to lead R_{θJL} and lead to ambient.

E. The static characteristics in Figures 1 to 6 are obtained using <300μs pulses, duty cycle 0.5% max.

F. These curves are based on the junction-to-ambient thermal impedance which is measured with the device mounted on 1in² FR-4 board with 2oz. Copper, assuming a maximum junction temperature of T_{J(MAX)}=150° C. The SOA curve provides a single pulse rating.

TYPICAL ELECTRICAL AND THERMAL CHARACTERISTICS

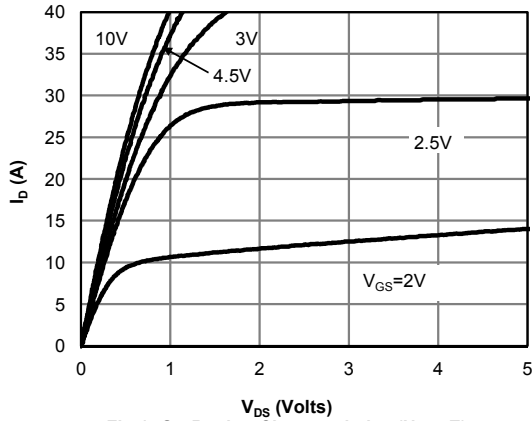

Fig 1: On-Region Characteristics (Note E)

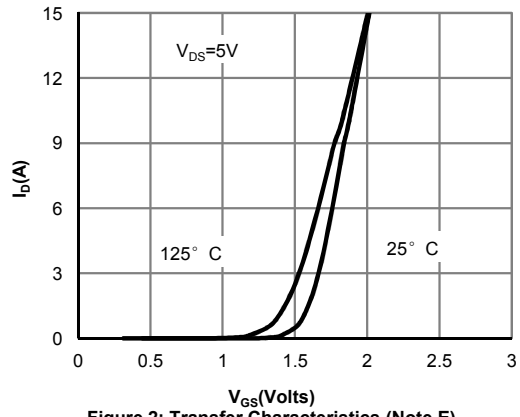

Figure 2: Transfer Characteristics (Note E)

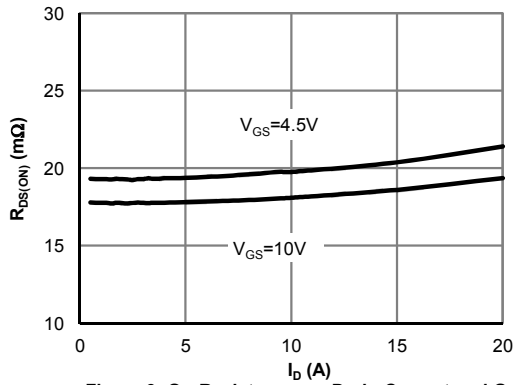

Figure 3: On-Resistance vs. Drain Current and Gate Voltage (Note E)

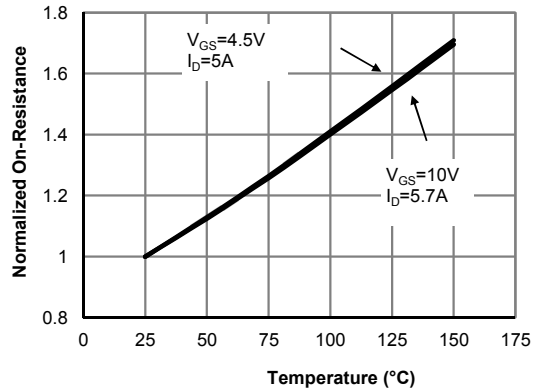

Figure 4: On-Resistance vs. Junction Temperature (Note E)

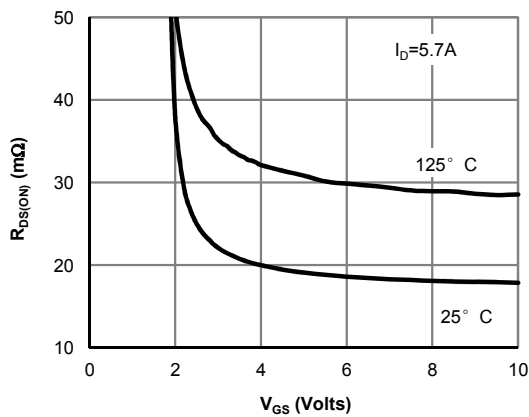

Figure 5: On-Resistance vs. Gate-Source Voltage (Note E)

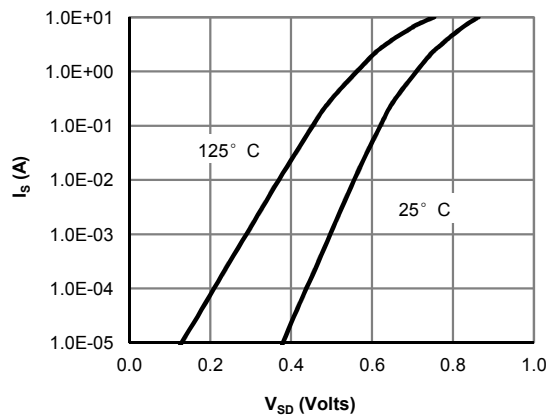

Figure 6: Body-Diode Characteristics (Note E)

TYPICAL ELECTRICAL AND THERMAL CHARACTERISTICS

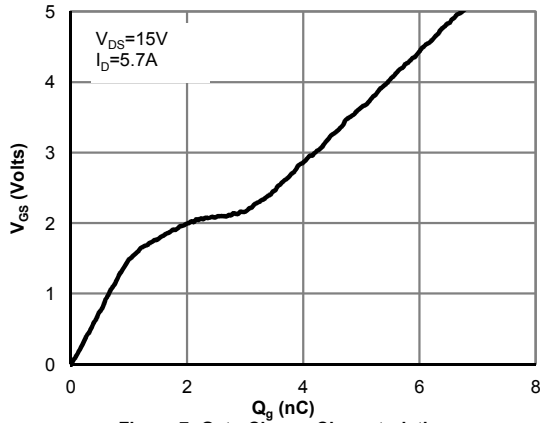

Figure 7: Gate-Charge Characteristics

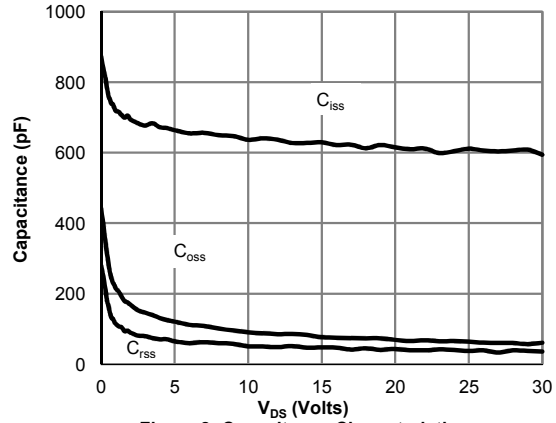

Figure 8: Capacitance Characteristics

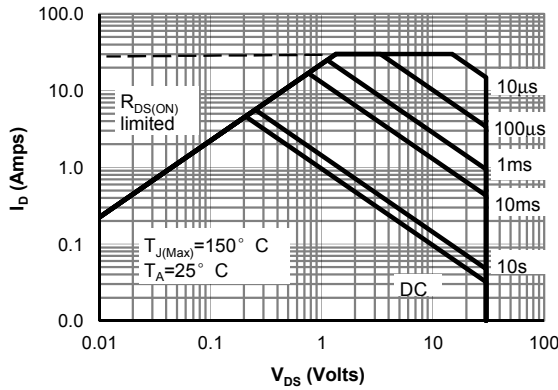

Figure 9: Maximum Forward Biased Safe Operating Area (Note F)

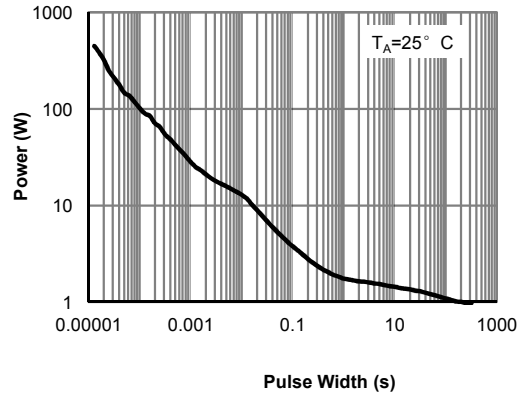

Figure 10: Single Pulse Power Rating Junction-to-Ambient (Note F)

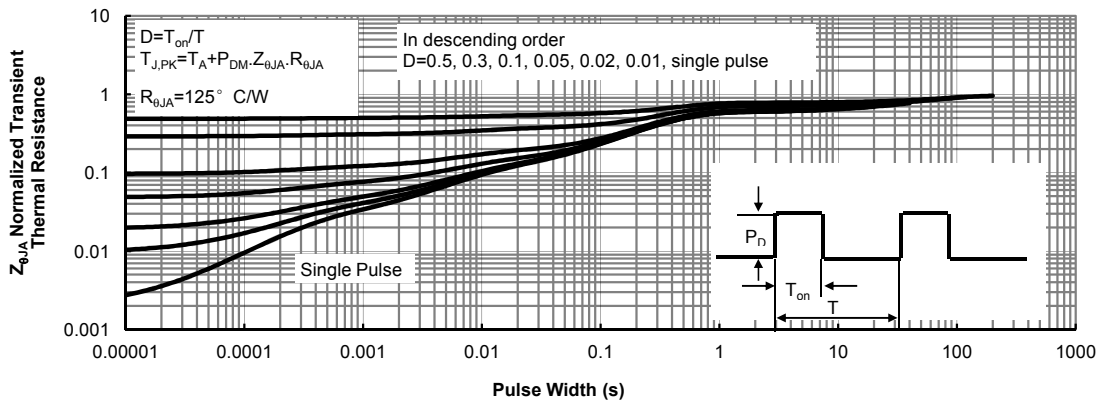
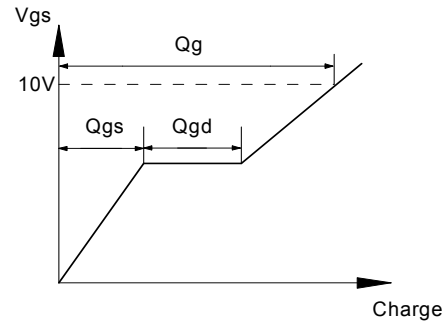
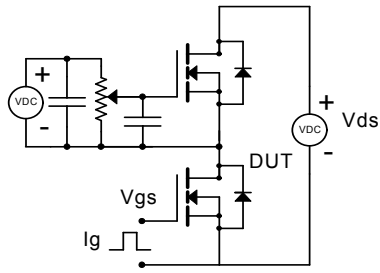
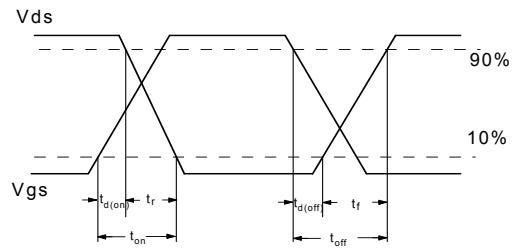
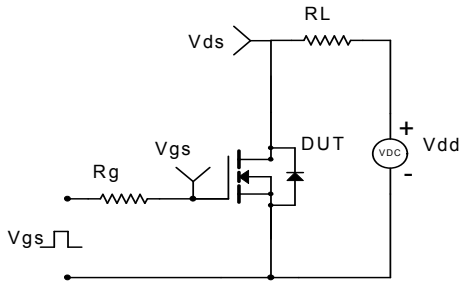

Figure 11: Normalized Maximum Transient Thermal Impedance (Note F)

Gate Charge Test Circuit & Waveform



Resistive Switching Test Circuit & Waveforms



Diode Recovery Test Circuit & Waveforms

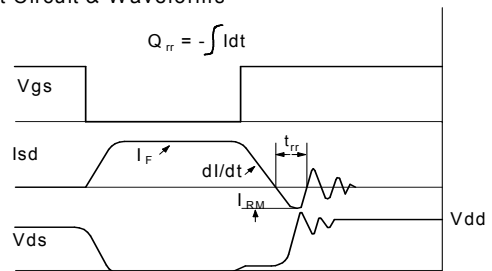
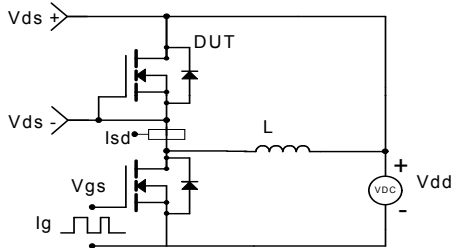

SOT-23 PACKAGE OUTLINE DIMENSIONS

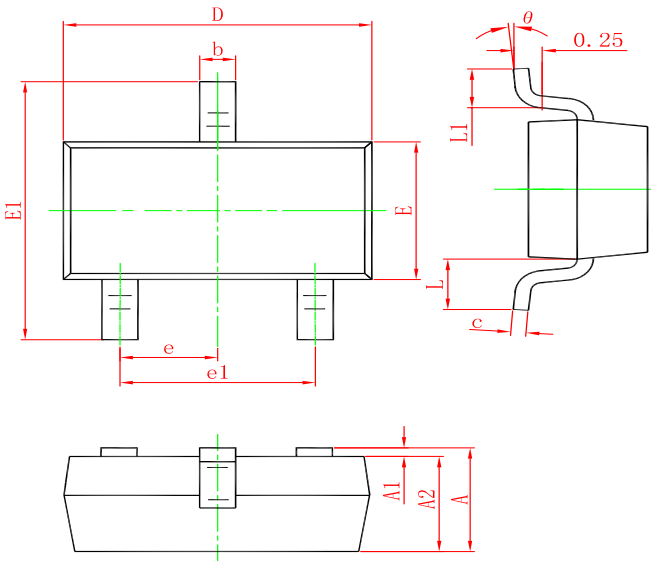

Symbol	Dimensions In Millimeters		Dimensions In Inches	
	Min.	Max.	Min.	Max.
A	0.900	1.150	0.035	0.045
A1	0.000	0.100	0.000	0.004
A2	0.900	1.050	0.035	0.041
b	0.300	0.500	0.012	0.020
c	0.080	0.150	0.003	0.006
D	2.800	3.000	0.110	0.118
E	1.200	1.400	0.047	0.055
E1	2.250	2.550	0.089	0.100
e	0.950 TYP.		0.037 TYP.	
e1	1.800	2.000	0.071	0.079
L	0.550 REF.		0.022 REF.	
L1	0.300	0.500	0.012	0.020
θ	0°	8°	0°	8°

Marking

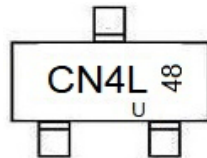

Ordering information

Order code	Package	Baseqty	Deliverymode
UMW AO3480A	SOT-23	3000	Tape and reel