

THIS DRAWING IS UNPUBLISHED. RELEASED FOR PUBLICATION  
 © COPYRIGHT - By - ALL RIGHTS RESERVED.

LOC	DIST	REVISIONS			
P	LTR	DESCRIPTION	DATE	DWN	APVD
AD	00	F3	REVISED PER ECO-11-010839	25MAY11	RK HMR

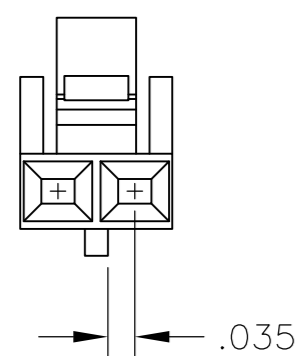

1 MATERIAL: FLAME RETARDANT THERMOPLASTIC, COLOR- BLACK.  
 2 THIS DIMENSION .480 FOR 2 POSN ONLY

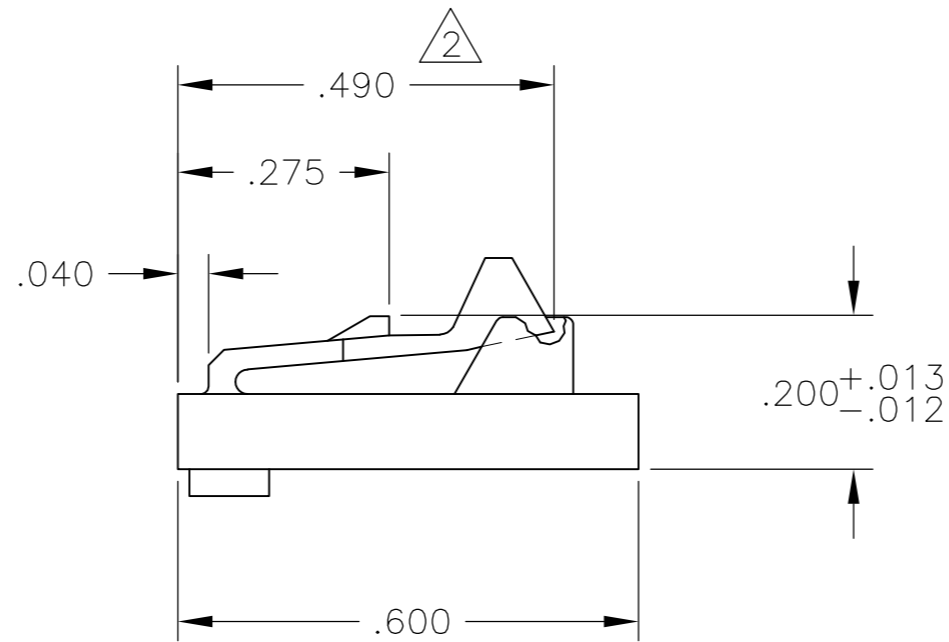
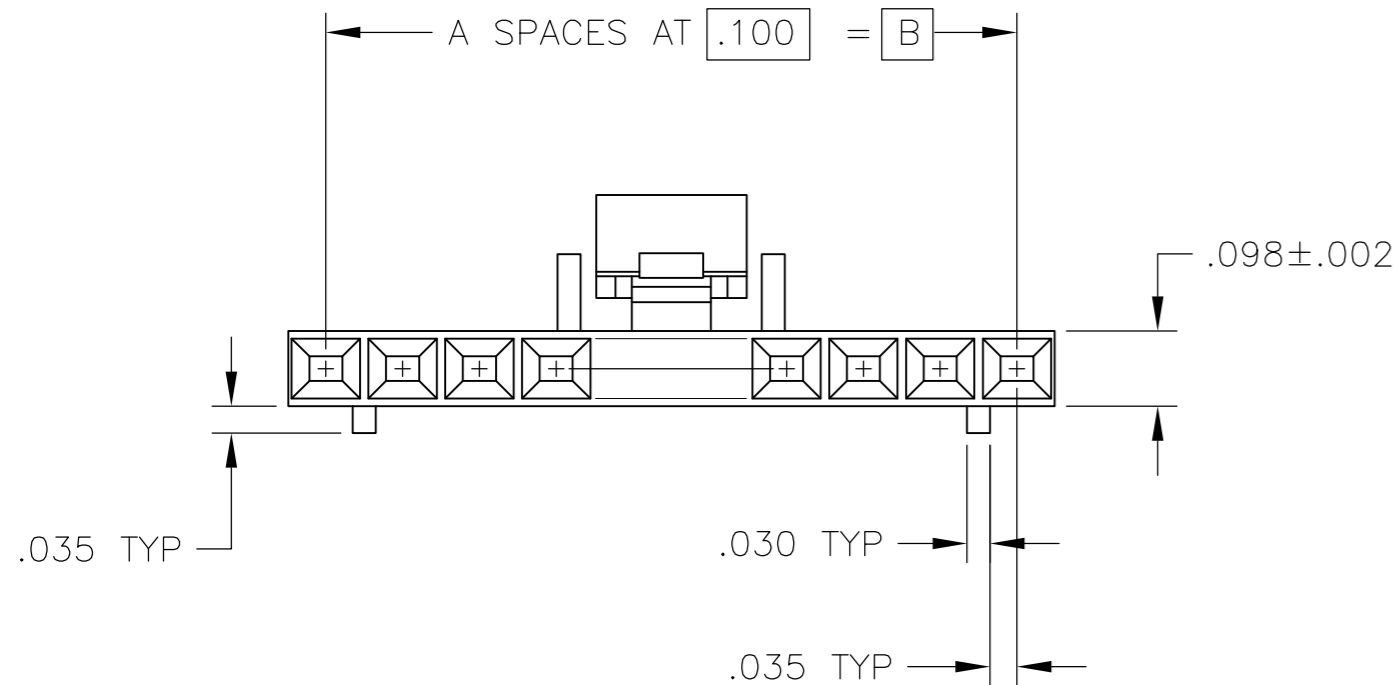

DETAIL FOR -1 ONLY  
(2 POSITION)

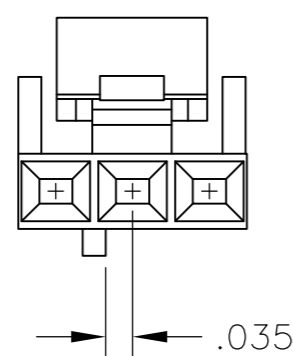

DETAIL FOR -2 ONLY  
(3 POSITION)

2.498	2.400	24	25	2-104257-4
2.398	2.300	23	24	2-104257-3
2.298	2.200	22	23	2-104257-2
2.198	2.100	21	22	2-104257-1
2.098	2.000	20	21	2-104257-0
1.998	1.900	19	20	1-104257-9
1.898	1.800	18	19	1-104257-8
1.798	1.700	17	18	1-104257-7
1.698	1.600	16	17	1-104257-6
1.598	1.500	15	16	1-104257-5
1.498	1.400	14	15	1-104257-4
1.398	1.300	13	14	1-104257-3
1.298	1.200	12	13	1-104257-2
1.198	1.100	11	12	1-104257-1
1.098	1.000	10	11	1-104257-0
.998	.900	9	10	104257-9
.898	.800	8	9	104257-8
.798	.700	7	8	104257-7
.698	.600	6	7	104257-6
.598	.500	5	6	104257-5
.498	.400	4	5	104257-4
.398	.300	3	4	104257-3
.298	.200	2	3	104257-2
.198	.100	1	2	104257-1

C	B	A	NO OF POSN	PART NUMBER
---	---	---	------------	-------------

THIS DRAWING IS A CONTROLLED DOCUMENT.		DWN R BROWN 02FEB2006	<b>TE</b> TE Connectivity	
DIMENSIONS: INCHES		CHK J GESFORD 02FEB2006		
TOLERANCES UNLESS OTHERWISE SPECIFIED:		APVD J GESFORD 02FEB2006	NAME	
0 PLC ± -		PRODUCT SPEC	RECEPTACLE HOUSING, AMPMODU	
1 PLC ± -		108-25034	MTE, SINGLE ROW, .100CL	
2 PLC ± -		APPLICATION SPEC	POLARIZED WITH LATCH	
3 PLC ± .005		114-25026	SIZE A2	CAGE CODE 00779
4 PLC ± -		WEIGHT -	DRAWING NO C=104257	RESTRICTED TO -
ANGLES ± -		CUSTOMER DRAWING	SCALE 4:1	SHEET 1 of 1
FINISH -			REV F3	

# Mouser Electronics

Authorized Distributor

Click to View Pricing, Inventory, Delivery & Lifecycle Information:

[TE Connectivity:](#)

[1-104257-4](#)