

ACPDQC5V0ESPC-HF

RoHS Device
Halogen Free



Features

- Bi-directional ESD protection.
- IEC 61000-4-2 ESD protection up to $\pm 25\text{kV}$ (Contact).
- Surface mount package.
- Ultra small SMD package:0402C
- High component density.
- Low clamping voltage.
- Low leakage.
- Ultra-Low capacitance: 0.28 pF(typ.)
- Comply with AEC-Q101

Mechanical data

- Case: 0402C/SOD-923F standard package, molded plastic.
- Terminals: Gold plated, solderable per MIL-STD-750, method 2026.
- Mounting position: Any.
- Weight: 0.001 grams(approx.).

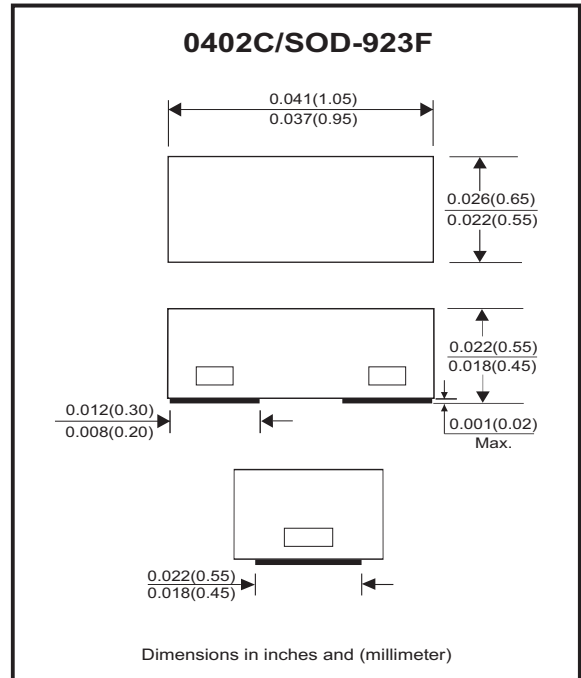

Circuit diagram



Maximum Rating (at $T_A=25^\circ\text{C}$ unless otherwise noted)

Parameter	Conditions	Symbol	Value	Unit
Peak pulse power	$T_P = 8/20\mu\text{s}$	P_{PP}	100	W
Peak pulse current	$T_P = 8/20\mu\text{s}$	I_{PP}	4	A
ESD capability	IEC 61000-4-2(air) IEC 61000-4-2(contact)	ESD	± 25	kV
Operation temperature range		T_j	-40~+125	$^\circ\text{C}$
Storage temperature range		T_{STG}	-55~+150	$^\circ\text{C}$

Electrical Characteristics (at $T_A=25^\circ\text{C}$ unless otherwise noted)

Parameter	Conditions	Symbol	Min	Typ	Max	Unit
Working peak reverse voltage		V_{RWM}			5	V
Breakdown voltage	$I_T = 1\text{mA}$	V_{BR}	7	9		V
Reverse leakage current	$V_{RWM} = 5\text{V}$	I_R		<1	50	nA
Clamping voltage	$I_{PP} = 1\text{A}, T_P = 8/20\mu\text{s}$	V_C		13	15	V
	$I_{PP} = 4\text{A}, T_P = 8/20\mu\text{s}$			20	25	
Clamping voltage	$I_{PP} = 8\text{A}, T_P = 100\text{ns}$	V_{CL}		25		V
	$I_{PP} = 16\text{A}, T_P = 100\text{ns}$			35		
Dynamic resistance		R_{DYN}		1.3		Ω
Junction capacitance	$V_R = 0\text{V}, f = 1\text{MHz}$	C_J		0.28	0.35	pF

RATING AND CHARACTERISTIC CURVES (ACPDQC5V0ESPC-HF)

Fig.1 - 8/20us Peak Pulse Current Waveform Acc. IEC 61000-4-5

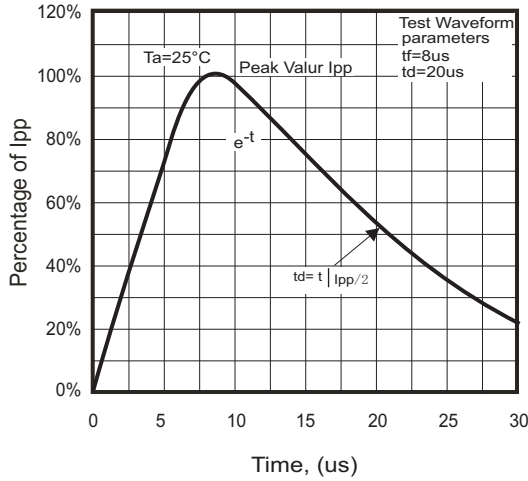

Fig.2 - Power Rating Derating Curve

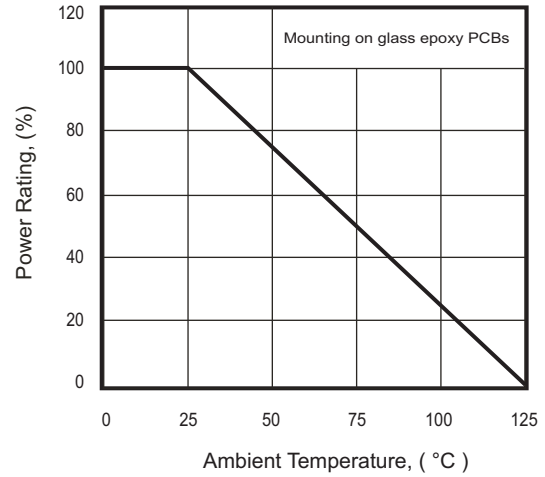

Fig.3 - Capacitance Between Terminals Characteristics

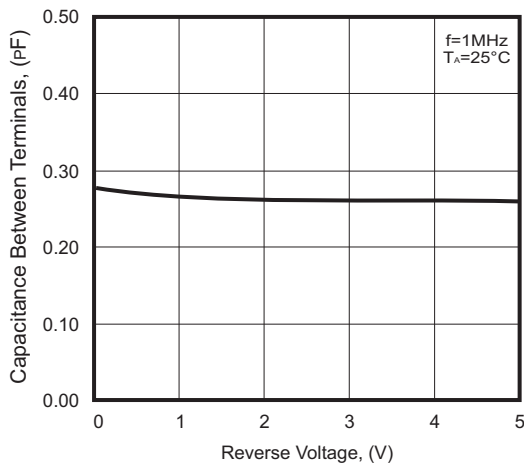

Fig.4 - Clamping Voltage Vs. Peak Pulse Current

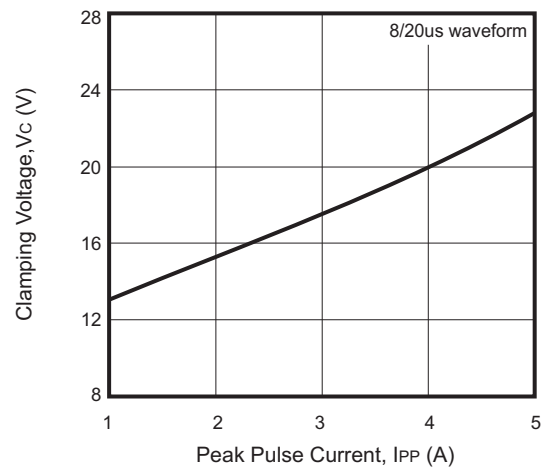

Fig.5 - Insertion Loss, Typical Values

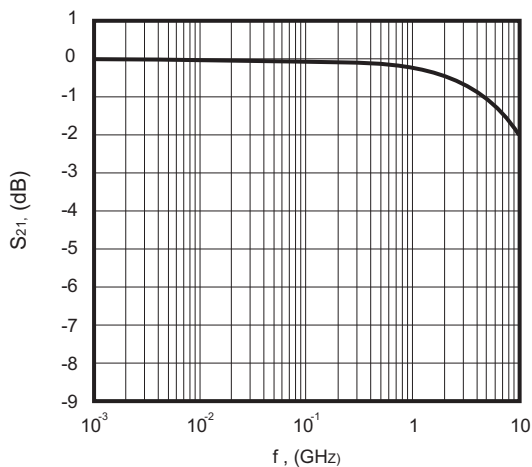
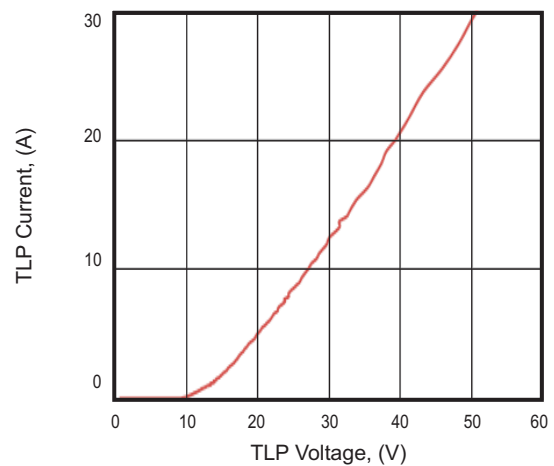
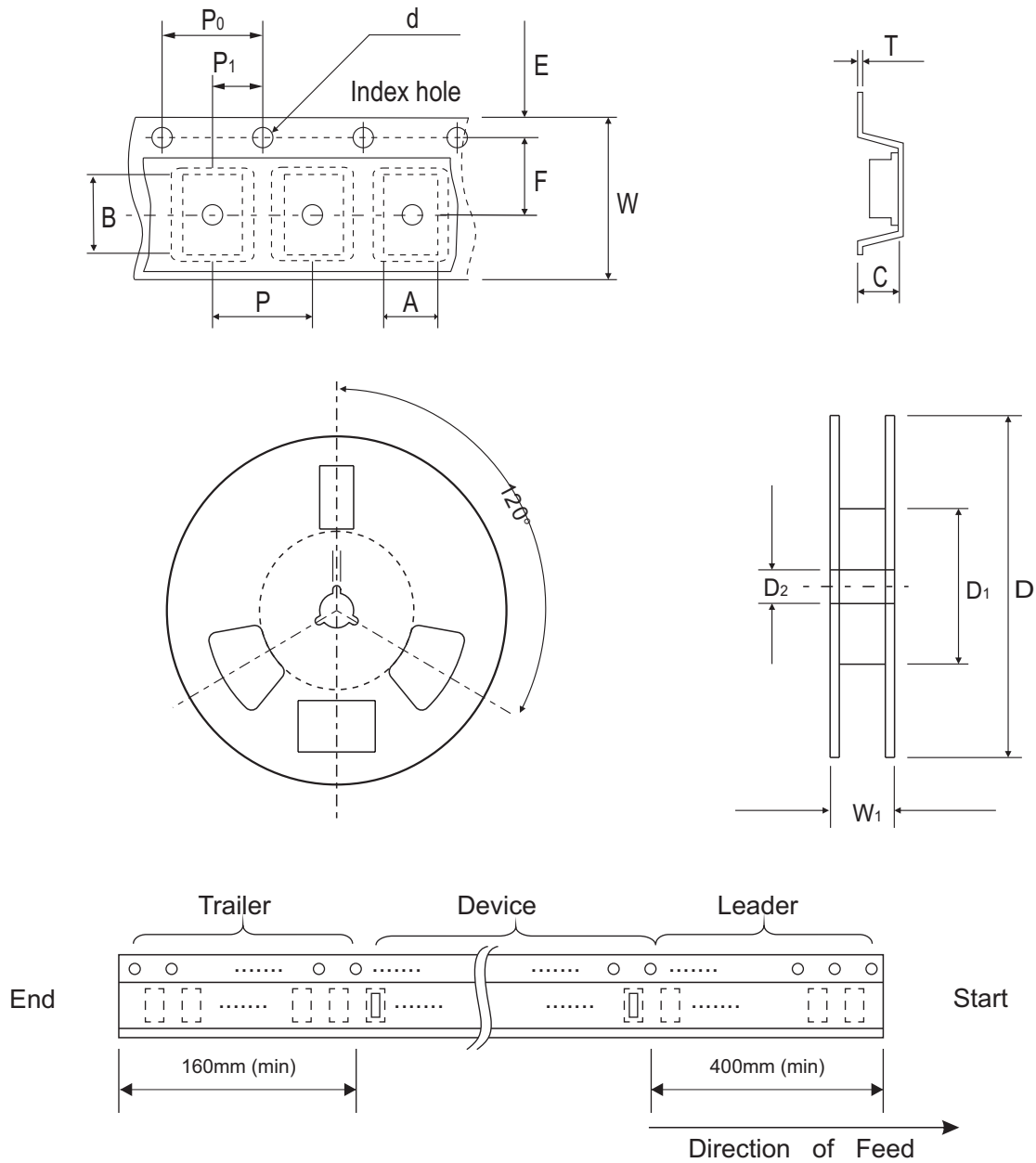

Fig.6 - Positive TLP IV Curve



Reel Taping Specification



0402C (SOD-923F)	SYMBOL	A	B	C	d	D	D ₁	D ₂
	(mm)	0.75 ± 0.05	1.17 ± 0.05	0.65 ± 0.05	1.50 + 0.10 - 0	178.00 ± 1.00	60.00 ± 0.50	13.50 ± 0.20
	(inch)	0.030 ± 0.002	0.046 ± 0.002	0.026 ± 0.002	0.059 + 0.004 - 0	7.008 ± 0.039	2.362 ± 0.020	0.531 ± 0.008

0402C (SOD-923F)	SYMBOL	E	F	P	P ₀	P ₁	T	W	W ₁
	(mm)	1.75 ± 0.10	3.50 ± 0.10	4.00 ± 0.10	4.00 ± 0.10	2.00 ± 0.10	0.20 + 0.02 - 0.05	8.00 ± 0.20	12.00 + 0.50 - 0
	(inch)	0.069 ± 0.004	0.138 ± 0.004	0.157 ± 0.004	0.157 ± 0.004	0.079 ± 0.004	0.008 + 0.001 - 0.002	0.315 ± 0.008	0.472 + 0.020 - 0

Company reserves the right to improve product design, functions and reliability without notice.

REV:A

Marking Code

Part Number	Marking Code
ACPDQC5V0ESPC-HF	5SP



Suggested PAD Layout

SIZE	0402C/SOD-923F	
	(mm)	(inch)
A	0.70	0.028
B	0.40	0.016
C	0.60	0.024
D	1.10	0.043
E	0.30	0.012

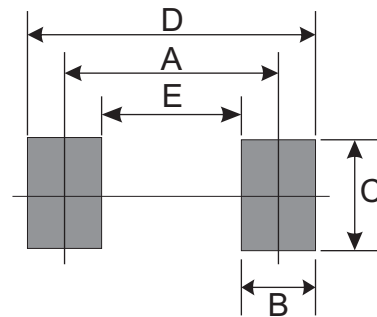

Standard Packaging

Case Type	REEL PACK	
	REEL (pcs)	Reel Size (inch)
0402C/SOD-923F	5,000	7

Mouser Electronics

Authorized Distributor

Click to View Pricing, Inventory, Delivery & Lifecycle Information:

[Comchip Technology:](#)

[ACPDQC5V0ESPC-HF](#)